



**MITSUBISHI  
ELECTRIC**

*Changes for the Better*

**AIR CONDITIONING SYSTEMS**

# CITY MULTI



# City Multi VRF Air Conditioning

Today's commercial buildings are increasingly air tight and filled with heat generating office equipment and lighting, which presents a problem for anyone trying to maintain a stable and comfortable internal environment.

With continual improvements through extensive research and development, our innovative and pioneering City Multi VRF air conditioning systems deliver the ultimate in efficiency and ability whilst providing comfort and control to many building types.

## The name Mitsubishi is synonymous with excellence

Founded in 1921, Mitsubishi Electric is now a global, market leading environmental technologies manufacturer. The living Environment Group pioneering solutions that cool, heat, ventilate and control our buildings in some of the most energy efficient ways possible.

We believe that global climate challenges need local solutions. Our aim is to help individuals and businesses reduce the energy consumption of their buildings and their running costs.

Providing accurate and controlled comfort all year round, our air conditioning range can work on their own or in conjunction with other systems in a hybrid solution. Whatever the requirement we offer a solution that matches the needs of almost any building.

At Mitsubishi Electric we have evolved and today we offer advanced environmental systems that really can **make a world of difference**.



## Contents

Features of Mitsubishi Electric air conditioners	Page 2-19
Outdoor Unit	Page 21-75
Indoor Unit	Page 77-128
Remote Controller	Page 129-149
Optional Parts	Page 150-153
Installation Information	Page 154-159
Maintenance Equipment	Page 160

The ultimate heating and cooling solution for your building

# The New YKB/YLM Series



**New Technology** (PUHY/PURY-EP-Y(S)LM-A(-BS) only)

The world-first\*<sup>1</sup> flat-tube heat exchanger significantly improves heat exchange performance achieving high SEER/SCOP and high air-conditioning capacity.

## Conventional Heat Exchanger

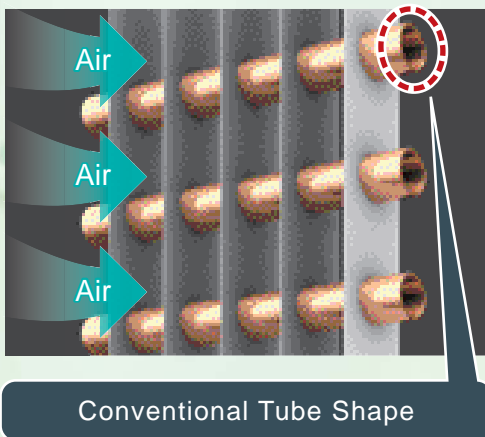

## Flat-tube Heat Exchanger

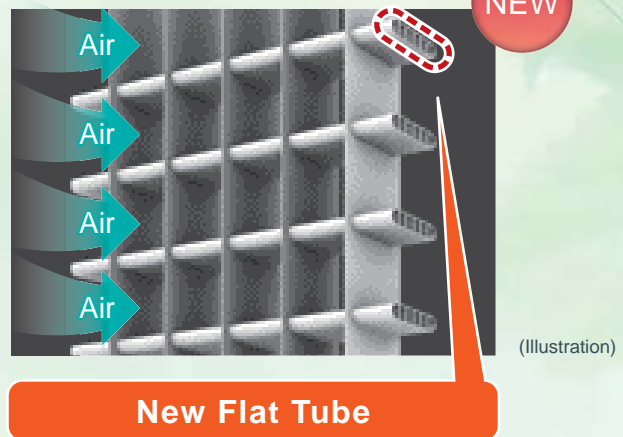

The heat exchanger of the outdoor unit has been drastically changed. Our new outdoor unit model uses a world-first\*<sup>1</sup> aluminum flat-tube heat exchanger. The flat tubes reduce airflow resistance, and the larger number of tubes can be installed in the flat-tube heat exchanger compared to our conventional heat exchanger, which then increases the surface area that is in contact with the refrigerant, hence improving the performance of the heat-exchanger. Our new air conditioner, therefore, operates at higher SEER/SCOP and maintains the required cooling/heating capacity.

**Energy Saving** (PUHY/PURY-EP-Y(S)LM-A(-BS) only)

The new YLM series features various advanced technologies including the world-first\*<sup>1</sup> flat-tube heat exchangers, optimum distribution of refrigerant, high efficiency compressor and DC fan motors.

### Comparison of SEER and SCOP (between PUHY-EP-YJM-A and PUHY-EP-YLM-A)

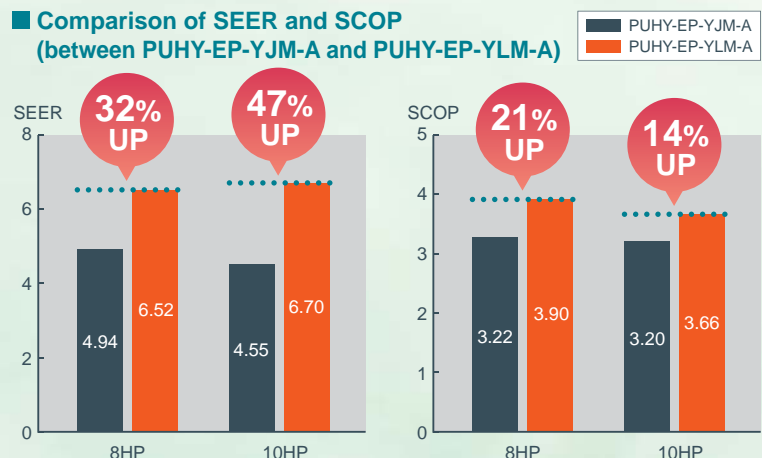

\*1: As of October 2013 (according to Mitsubishi Electric, Japan survey); for VRF systems  
 \*2: CITY MULTI series PUHY-EP-Y(S)JM-A  
 \*3: Any continuous operation over 46°C may require an increased frequency of maintenance.  
 \*4: Except for EP300 and EP350 models

**New Technology**

## Equipped with High Efficiency Compressor

Optimizing the capacity of the scroll compressor and modifying the winding of the compressor motor have led to the improvement in operating efficiency by approximately 2 to 7% during partial-load operation.

### Relationship between Compressor's Frequency and Efficiency

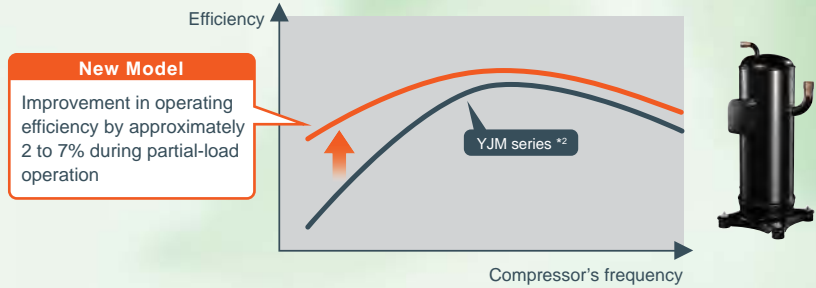

**Flexibility of Design**

(PUHY-P-Y(S)KB-A(-BS)/PUHY-EP-Y(S)LM-A(-BS))

## The new model can work in cooling mode successfully even at high ambient temperature.

Enhancement in performance in consideration of the actual installation environment of the outdoor unit - expands the cooling operation temperature range up to the ambient temperature of 52°C

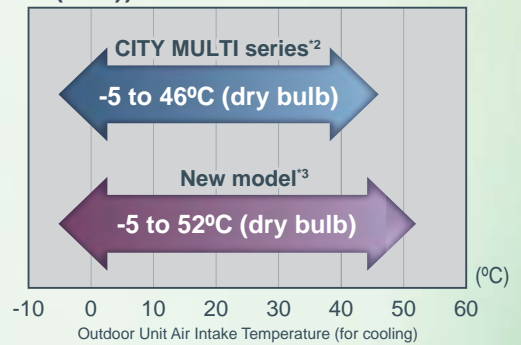

**Reliability**

(PUHY/PURY-EP-Y(S)LM-A(-BS) only)

## Less amount of refrigerant is required to be charged on site.

With our new flat-tube heat exchanger, the amount of refrigerant to be charged on site can be controlled and reduced. For example, when the total refrigerant piping length is 150 m, the amount of refrigerant to be charged on site can be reduced by approximately 10% compared to our conventional models, achieving reduction in cost and time of the construction work.

\*In the case of liquid pipe  $\phi$ 19.05

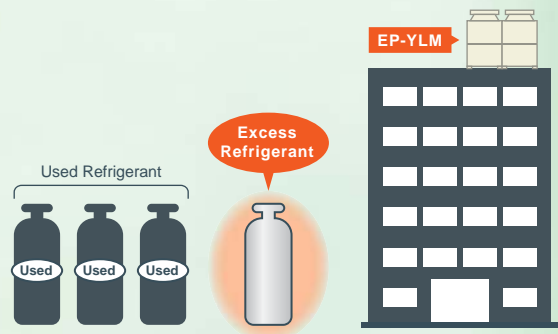

**New Technology**

(PUHY-EP-Y(S)LM-A(-BS) only)<sup>4</sup>

## Optimum Distribution of Refrigerant Using a BSC Circuit

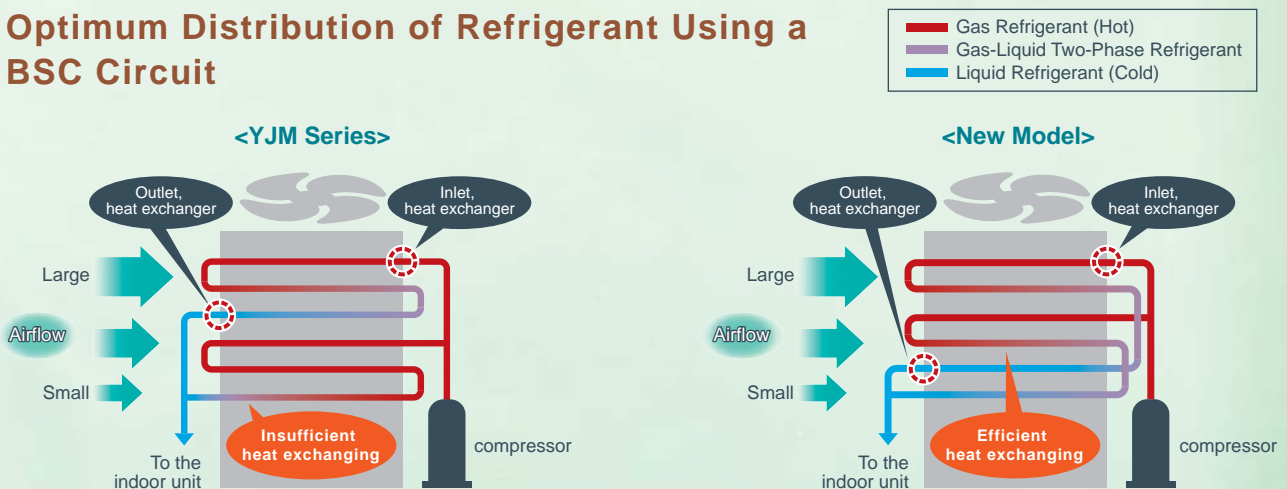

The uniform distribution of the gas-liquid two-phase refrigerant flow throughout the heat exchanger resulted in insufficient heat exchange at the lower part of the heat exchanger where the airflow was lower.

At the upper part of the heat exchanger where the airflow is higher, the gas-liquid two-phase refrigerant has a large cooling capacity which is distributed intensively. This function leads to efficient use of the unit's heat exchanging capacity.



# Sophisticated Yet Simple Technology

## Reliable

Designed and manufactured to the highest standards, the CITY MULTI range offers one of the most reliable air conditioning systems available. Simple to install and easy to maintain, so this range provides ideal solutions you can trust to protect your investment.



PEFY-VMS1



PEFY-VMR



PFFY-VKM

**>All the CITY MULTI outdoor units are made under stringent control.**

# VRF Systems

## Our Answer to VRF

Mitsubishi Electric sets the boundaries of VRF technology with the CITY MULTI range, which is available using R410A refrigerant with zero ODP (Ozone Depletion Potential). The range has been specifically designed for today's building requirements and addresses key market issues such as energy efficiency, adaptability and reliability. With user friendly control systems utilising internet technology and integrated cooling and ventilation indoor units, CITY MULTI is the benchmark and market leader in VRF technology.

VRF is a multi and direct expansion type air conditioning system where by one outdoor unit can be connected with multiples indoor units. The amount of refrigerant can be regulated freely according to the load on the indoor unit by the inverter driven compressor in the outdoor unit. Zoning in a small office is possible with a small capacity indoor unit. Energy conservation is easily handled because individual indoor units can stop and start their operation as needed. There are various indoor units available in order to suit various interior design needs.

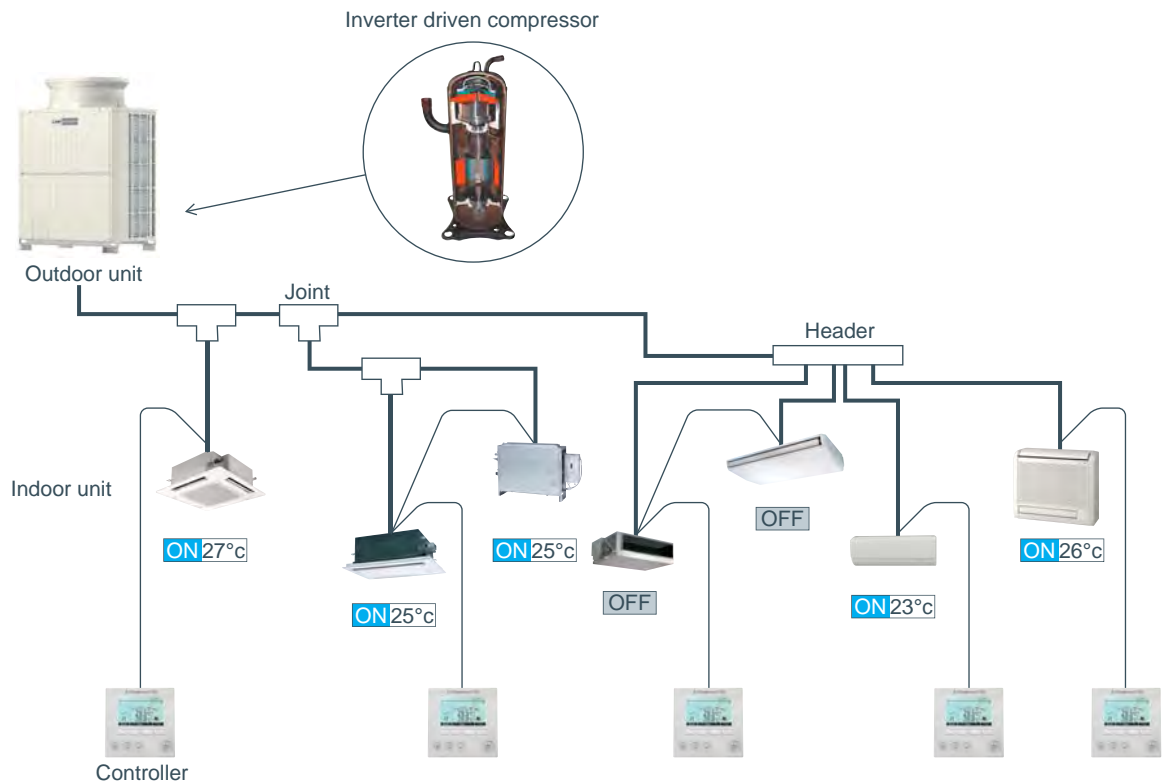



# Unbeatable Efficiency

## Heat Interchange Circuit

The unique Heat Interchange Circuit (HIC) enhances efficiency by providing additional sub-cooling and allows the expansion device to effectively control the refrigerant distribution, thereby increasing the operating efficiency and reducing the volume of refrigerant in each system.

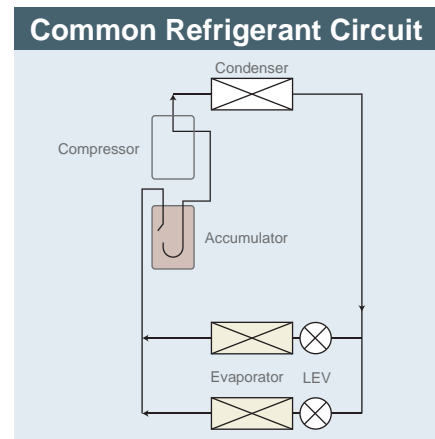
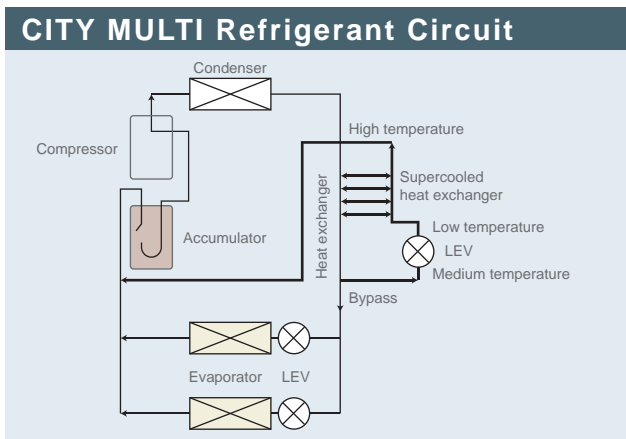



# Inverter Driven Compressor Technology



Low Starting Currents

## Using inverter driven technology is energy efficient for several reasons:

The compressor varies its speed to match the indoor cooling or heating demand and therefore only consumes the energy that is required.

When an inverter driven system is operating at partial load, the energy efficiency of the system is significantly higher than that of a standard fixed speed, non inverter system.

The fixed speed system can only operate at 100%, however, partial load conditions prevail for the majority of the time. Therefore, fixed speed systems cannot match the annual efficiencies of inverter driven systems.

Using proven single inverter driven compressor technology, the CITY MULTI range is favored by the industry for low starting currents (only 8 amps for a 50kW YLM-A outdoor unit) and smooth transition across the range of compressor frequencies.

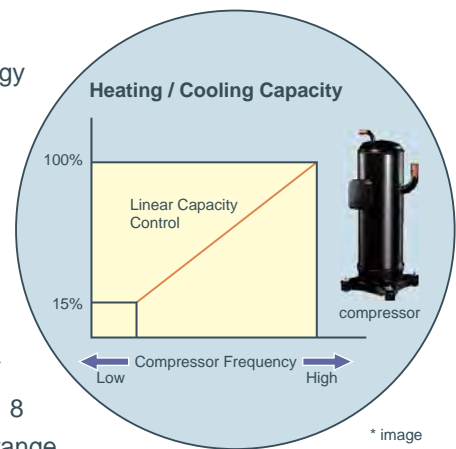

\* image

\* The values vary depending on the actual conditions such as ambient temperature.

### All CITY MULTI compressors are inverter-driven type.

#### -Capable of precisely matching a building's cooling and heating demands. (High COP model)

The outdoor unit combinations include 1 unit for 22.4-50kW systems (for Y and R2 series), 2 units for 56-69kW systems (for R2, 56-101kW) and 3 units for 73-151.2kW systems (Y series only). Each unit carries one inverter compressor making simple and highly reliable control possible.

Not only does it allow low starting currents, the inverter-driven compressor also provides precise indoor comfort and adapts to the air conditioning load.

### Stable and Smooth Operation

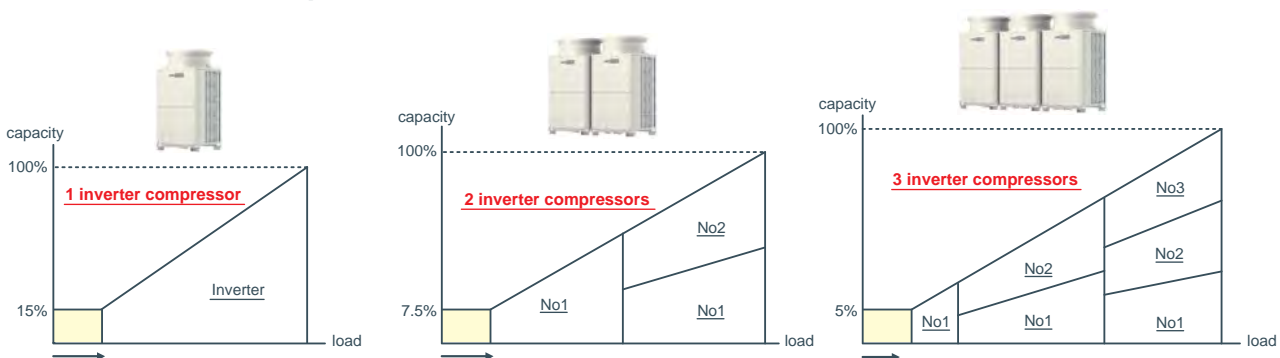

# Total Energy Conservation

## Comparison of COP (energy efficiency) – 22.4kW system

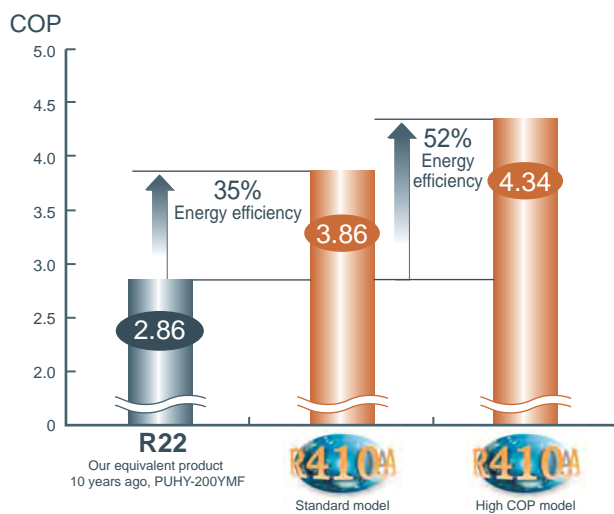

High COP (Coefficient of Performance) is realized

\* Average COP of cooling / heating  
\* The values were obtained under the standard conditions.

# Intelligent Power Module (IPM) Technology

The YLM-A range from Mitsubishi Electric provides precise control of energy input, through utilisation of its Intelligent Power Module (IPM) technology. By employing this technology it is possible to closely match the building requirements, achieving more accurate control of the occupied space. By using incremental 1Hz steps of capacity control, the amount of power input required is significantly reduced, resulting in greatly improved COP's.

In addition, IPM technology ensures effective performance under partial load conditions, a condition that most systems will be in for the majority of the normal working life cycle. By taking into account the efficiency at both part load and peak load conditions, R410A CITY MULTI is designed to provide unbeatable year round/seasonal efficiency.

## The Difference between YLM-A and Previous Mitsubishi Electric Models

**Technology is the key when increased efficiency is demanded.  
The CITY MULTI YLM-A range is able to deliver this in simple ways.**

A highly efficient R410A scroll compressor design results in less friction losses at the motor. A simplified refrigerant circuit (low pressure loss) including a new accumulator design also adds a few more points to the efficiency scale. Enhancements to the heat interchange circuit, an inverter driven fan motor and a heat exchanger design again add vital increases to overall system efficiencies and COPs.

## The Importance of COP

COP stands for "Coefficient of Performance". It is a measure of the useful energy a system can deliver compared to the energy it consumes. It is calculated by dividing the energy output by the energy input of a system. The higher the figure then the more efficient the system is deemed to be.



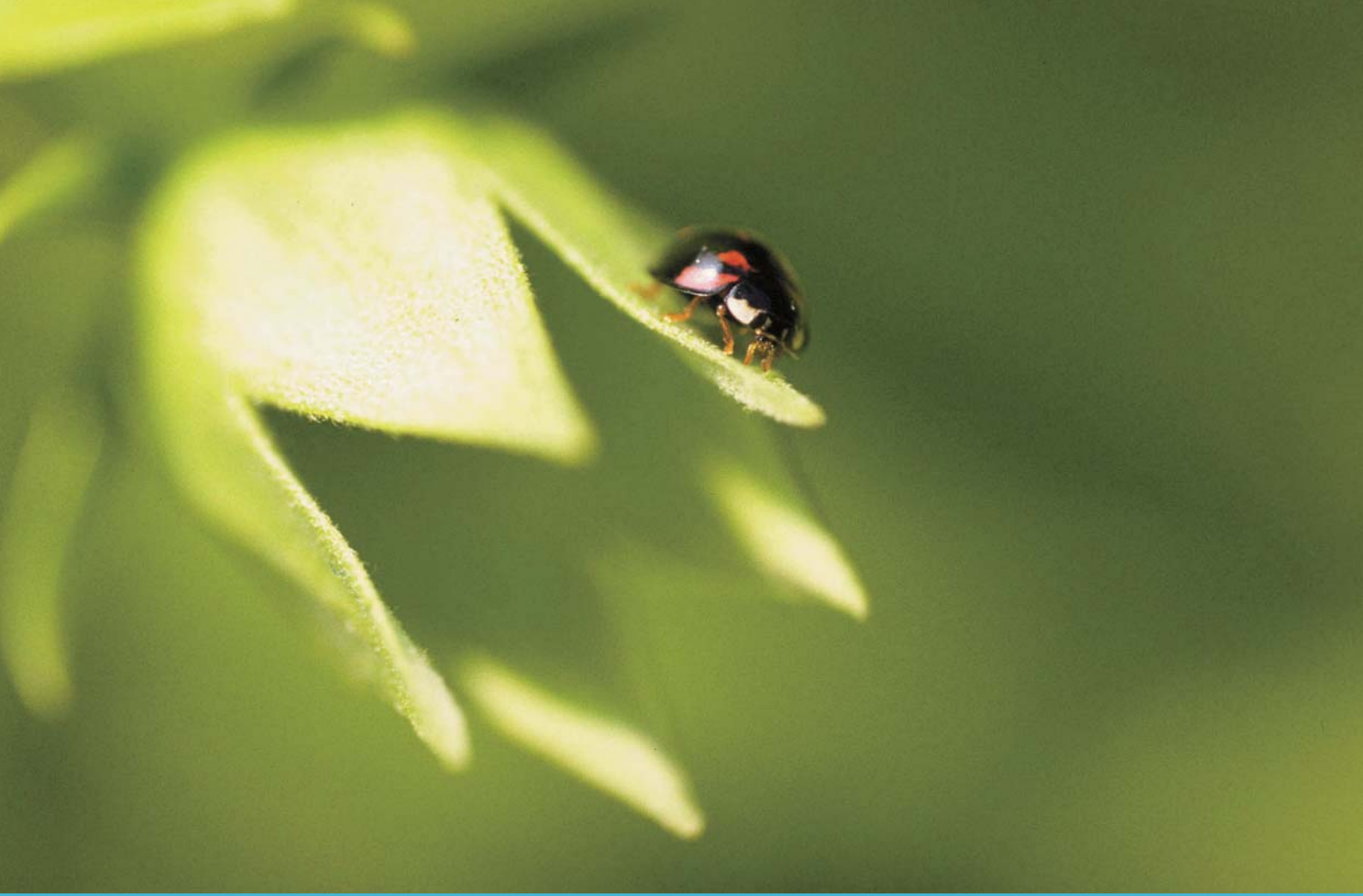

# For the Environment

Enhancing Environmental Care (measures for the RoHS Directive and the refrigerant reduction)

Every unit is in compliance with the RoHS Directive,\* which stands for the Restriction of Hazardous Substances: Lead-free soldering is used to avoid Lead Groundwater Contamination on the printed circuit board (PCB). The amount of refrigerant on the unit has also been reduced to enhance environmental care.

\* RoHS Directive: the restriction of the use of certain hazardous substances in electrical and electronic equipment that has been sold in EU since July 2006

# Efficient R410A Refrigerant



## History of Refrigerant

R22, an HCFC-based refrigerant, had been a popular choice for most chillers. However, R22 has been targeted by the Montreal Protocol to be phased out in new equipment. Additionally, governments in many countries are enforcing a ban of HCFC-based refrigerants for new installations.

Because of these restrictions, R410A refrigerants are desirable. R410A is a blend of HFCs, which do not deplete the ozone.

## Technical Aspects of Refrigerant

R410A is a more efficient refrigerant as it has a higher specific heat capacity when compared to R407C or R22. This higher energy carrying capacity allows for smaller pipe sizes, longer pipe runs and reduces the volume of refrigerant within a system. This is a major factor when concerning safety and environmental requirements in the design, manufacture, installation, operation, maintenance and disposal of refrigerating systems.

## New Design

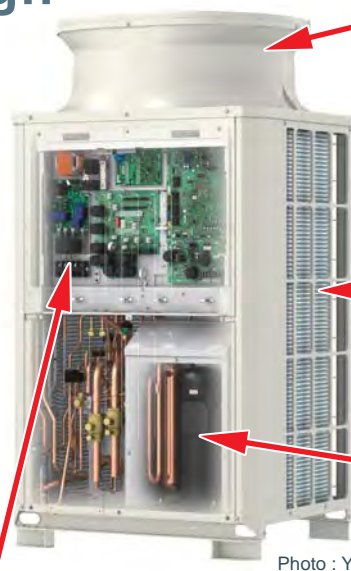

Photo : Y-YLM series

New Unit Casing

Reduction in fan input power

New Heat Exchanger Design

Improvement of COP

New Inverter Compressor

Improvement of COP

New Control Box Design

Improvement of reliability and easy maintenance

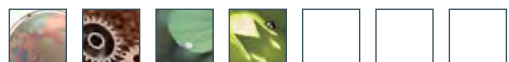



# Affordable & Effective

air conditioning you can rely on

By the heat recovery system, the more frequently cooling and heating simultaneous operation is carried out, the higher energy-saving effect becomes.

Operation Pattern of CITY MULTI *R2* System

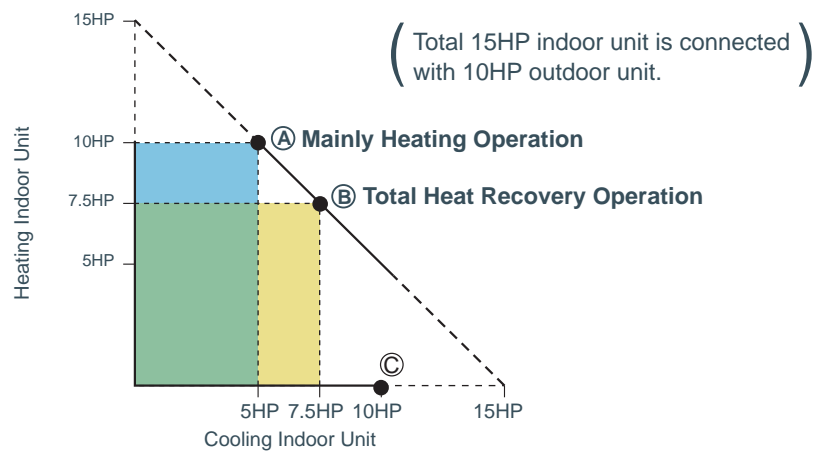

**Unique to Mitsubishi Electric**, our heat recovery technology uses just two pipes, as opposed to the market conventional three. Our R2 system designed for effective simultaneous heating and cooling, offers substantial savings on installation and annual running costs.

## Why Heat Recovery?

Flexibility and efficiency are key factors when selecting a heat recovery system. For example, while a heat pump system is adequate for a large open-plan office, an office that has a more partitioned structure will require the need to simultaneously heat or cool different sections of the office according to each user's individual preferences. The efficiency of this type of system comes from the ability to use the by-products of cooling and heating to transfer energy where it is required, thus acting as a balanced heat exchanger achieving energy savings over a conventional heat pump system. The number of connection sites needed for a R2 system are also significantly lower than those needed for a three pipe version. This helps to reduce installation costs, further increasing the savings associated with CITY MULTI.

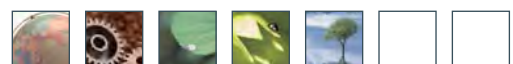
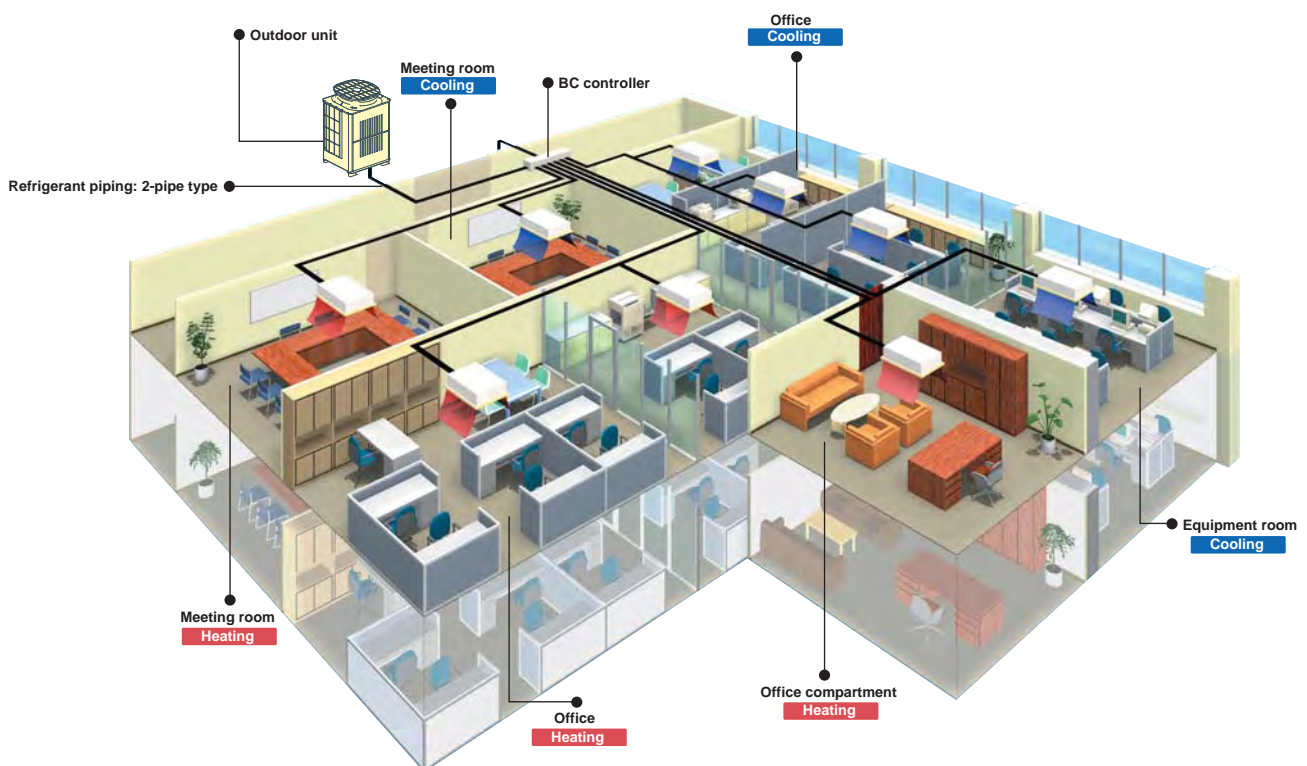



# “2-pipe” System Provides Better Efficiency and Performance

## Comparison Example of Piping Connection Sites

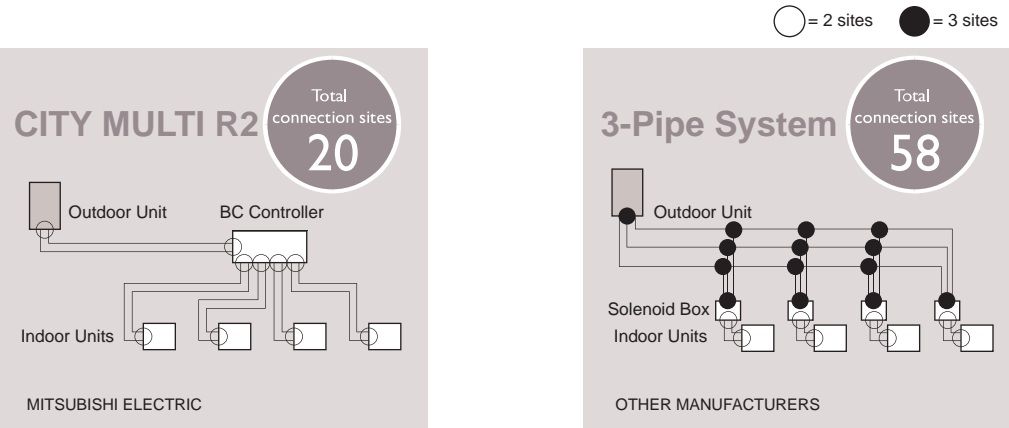



# The World's First and Only "2-pipe" System

## How does the R2 Heat Recovery System Operate on 2-Pipe's?

The secret of CITY MULTI heat recovery systems lies in the

### BC Controller

The BC Controller houses a liquid/gas separator, allowing the outdoor unit to deliver a mixture (2-phase) of hot gas for heating and liquid for cooling, all through the same pipe. Three pipe systems allocate a pipe to each of these phases. When this mixture arrives at the BC Controller, it is separated and the correct phase delivered to each indoor unit depending on the individual requirement of either heating or cooling.

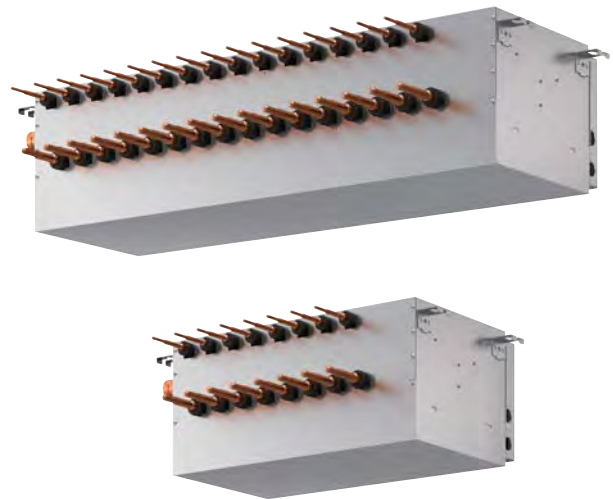

**1** High pressure and low pressure decides the compressor frequency, the mode of heat exchanger, and control the amounts of heat exchange.



High pressure gas-liquid 2-phase refrigerant

### 2 R2 Refrigerant Circuit

Gas-liquid 2-phase refrigerant from outdoor unit into gas refrigerant and liquid refrigerant is divided by gas-liquid separator in BC Controller.

BC Controller divides refrigerant to each indoor unit properly in compliance with the operation mode of each indoor unit.

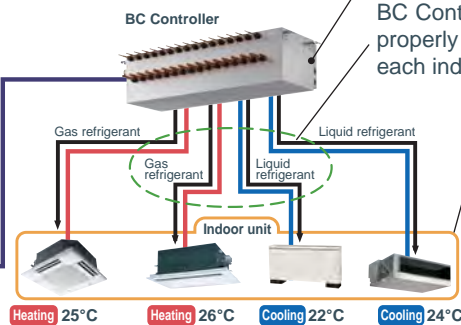

**3** Adjust the refrigerant flow by temperature difference between inlet and outlet.

Meet the demand of  
--- cooling / heating flexibly.

Heating=gas refrigerant  
Cooling=liquid refrigerant

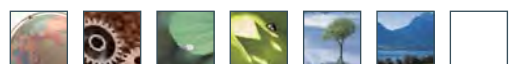



# Water Cooled CITY MULTI Benefits

Water cooled systems are ideally suited for use in temperate and cooler climates since heat exchange with the outside air is not required.

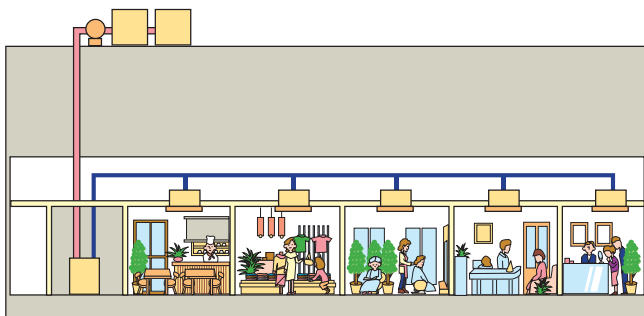

Water cooled systems can be used even in buildings that are taller than 50m by running a main water pipe through each floor.

Any heat source system that can supply heat source water between 10°C~45°C can be used.

**Simultaneous heating and cooling operation is available. (WR2 series)**

It is suggested that Water-Cooled systems are used in the buildings in which there are heating and cooling needs as follows.

- Buildings that require all year cooling  
Example,
  - Tenant buildings in which kitchens and offices exist together
  - Buildings in which equipment rooms and offices exist together
- Buildings where there are large room temperature differences
- Hotels in which there are a lot of individual room requirements

# Energy Saving Technology

## What is Water-Cooled?

>A unique offering from Mitsubishi Electric

It is possible now to combine the features of VRF with a water circuit using CITY MULTI WR2/WY. In this case the heat is rejected to a water source rather than to the outside air.

The advantages of water cooled systems are that the water can be delivered at optimised temperatures and volumes, which allows even greater flexibility and increased COP.



## WR2(Heat recovery type)

Mitsubishi Electric now offers double heat recovery operation.

The first heat recovery is within the refrigerant system. Simultaneous cooling and heating operation is available with heat recovery performed between indoor units.

The second heat recovery is within the water loop, where heat recovery is performed between the PQRY units. This double heat recovery operation substantially improves energy efficiency and makes the system the ideal solution to the requirements of modern office buildings, where some areas require cooling even in winter.

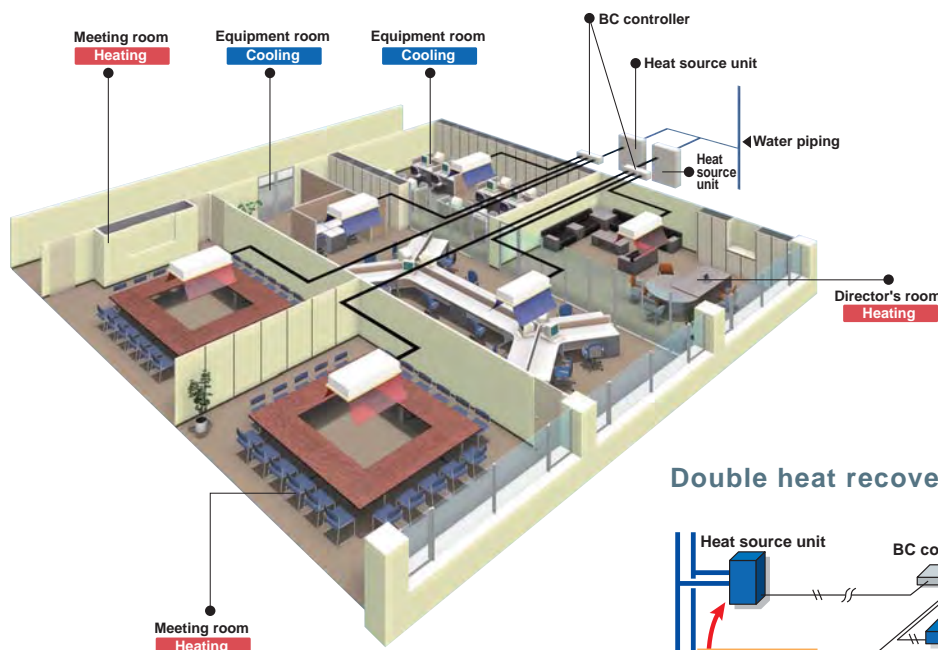

### Double heat recovery (WR2)

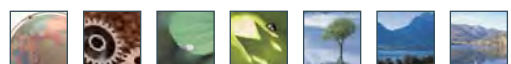
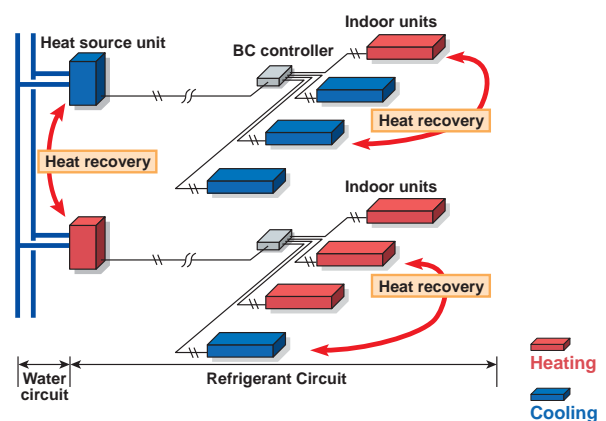



















## O Outdoor Unit

- **Heat Pump Series (S)**
- **Heat Pump Series (Y)**
- **Heat Pump Series - High COP (Y)**
- **Water Cooled Heat Pump Series (WY)**
- **Heat Recovery Series (R2)**
- **Heat Recovery Series - High COP (R2)**
- **Water Cooled Heat Recovery Series (WR2)**



# Wide Selection of Outdoor Units

System	Type	Model name	kW	12.5	14.0	15.5	22.4	28.0	33.5	40.0	45.0	
			Model	P112	P125	P140	P200	P250	P300	P350	P400	
Air Cooled	Heat Pump	<b>S series</b> <small>Page32 - Page33</small> <b>PUMY-P VKM-A(-BS)</b> <b>PUMY-P YKM-A(-BS)</b> 		12.5	14.0	15.5						
		<b>Y series</b> <small>Page34 - Page44</small> <b>PUHY-P YKB-A(-BS)</b> <b>PUHY-P YSKB-A(-BS)</b>   	S				22.4	28.0			22.4	
			L						33.5	40.0		
			XL									
		Heat Recovery	<b>Y series - High COP</b> <small>Page45 - Page55</small> <b>PUHY-EP YLM-A(-BS)</b> <b>PUHY-EP YSLM-A(-BS)</b>   	S				22.4	28.0			
				L						33.5	40.0	
			XL								45.0	
	Heat Recovery		<b>R2 series</b> <small>Page62 - Page67</small> <b>PURY-P YLM-A(-BS)</b> <b>PURY-P YSLM-A(-BS)</b>   	S				22.4	28.0			22.4
				L						33.5	40.0	
				XL								45.0
		Heat Recovery	<b>R2 series - High COP</b> <small>Page68 - Page72</small> <b>PURY-EP YLM-A(-BS)</b> <b>PURY-EP YSLM-A(-BS)</b>   	S				22.4	28.0			
				L						33.5	40.0	
			XL								45.0	
Water Cooled	Heat Pump		<b>WY series</b> <small>Page56 - Page61</small> <b>PQHY-P YHM-A</b> <b>PQHY-P YSHM-A</b> 					22.4	28.0	33.5		22.4
	Heat Recovery		<b>WR2 series</b> <small>Page73 - Page75</small> <b>PQRY-P YHM-A</b> <b>PQRY-P YSHM-A</b> 					22.4	28.0	33.5		22.4

\*1. Indicates S, L, XL modules

\*2. The circled numbers in the table indicate the Kilowatts(kW), and the combination of S, L, and XL modules.

	50.0	56.0	63.0	69.0	73.0	80.0	85.0	90.0	96.0	101.0	108.0	113.0	118.0	124.0	130.0	136.0	140.0	145.6	151.2	
	P450	P500	P550	P600	P650	P700	P750	P800	P850	P900	P950	P1000	P1050	P1100	P1150	P1200	P1250	P1300	P1350	
	22.4 28.0	28.0 28.0	28.0	28.0							28.0									
			33.5	40.0	33.5 40.0	40.0 40.0	40.0 45.0	40.0	45.0		33.5 45.0	33.5 40.0	33.5 40.0 45.0	40.0 40.0 45.0	40.0 40.0 45.0	40.0	45.0	40.0	45.0	
								50.0	50.0	50.0 50.0					50.0	50.0	50.0	50.0	50.0 50.0 50.0	
		28.0 28.0	28.0		22.4 22.4 28.0	22.4 22.4	22.4 28.0	22.4	28.0											
			33.5	33.5 33.5		33.5	33.5	33.5 33.5	33.5	33.5 33.5	33.5 40.0	33.5 33.5	33.5 40.0	40.0 40.0	40.0 40.0	40.0	40.0			
	50.0											45.0	45.0	45.0	50.0	45.0 50.0	50.0	45.0 50.0	50.0 50.0 50.0	
	22.4 28.0	28.0 28.0	28.0																	
			33.5	33.5 33.5	33.5 40.0	40.0 40.0	40.0 45.0	45.0 45.0	45.0											
		28.0 28.0	28.0							50.0	50.0									
			33.5	33.5 33.5	33.5 40.0	40.0 40.0	40.0													
	50.0						45.0	45.0 45.0	45.0 50.0	50.0 50.0										
	22.4 28.0	28.0 28.0	28.0 33.5	33.5 33.5	22.4 22.4	22.4 28.0	28.0 28.0	28.0 28.0	28.0 33.5	28.0 33.5										
	22.4 28.0	28.0 28.0	28.0 33.5	33.5 33.5																

# Y (Heat Pump) series



## Cooling or Heating

- Y series — [ PUHY-P YKB-A(-BS)  
PUHY-P YSKB-A(-BS)      PUHY-EP YLM-A(-BS)  
PUHY-EP YSLM-A(-BS)

## The two-pipe zoned system designed for Heat Pump Operation

The CITY MULTI Y series (for large applications) make use of a two-pipe refrigerant system, which allows for system changeover from cooling to heating, ensuring that a constant indoor climate is maintained in all zones. The compact outdoor unit utilizes R410A refrigerant and an INVERTER-driven compressor to use energy effectively. With a wide line-up of indoor units in connection with a flexible piping system, the CITY MULTI series can be configured for all applications. Up to 50 (Y series) indoor units can be connected with up to 130% connected capacity to maximize engineer's design options. This feature allows easy air conditioning in each area with convenient individual controllers.

### Large Offices (Y series)



[22.4-151.2kW (Y series)]  
[22.4-151.2kW (High COP Y series)]

Refrigerant Piping Lengths	Maximum meters [Feet]
Total length.....	1,000 [3,280]
Maximum allowable length.....	165 (190equivalent) [541 (623)]
Farthest indoor from first branch.....	40 [131]*1

Vertical differentials between units	Maximum meters [Feet]
Indoor/outdoor (outdoor higher).....	50 [164]*2
Indoor/outdoor (outdoor lower).....	40 [131]*3
Indoor/indoor.....	15 [49]*4

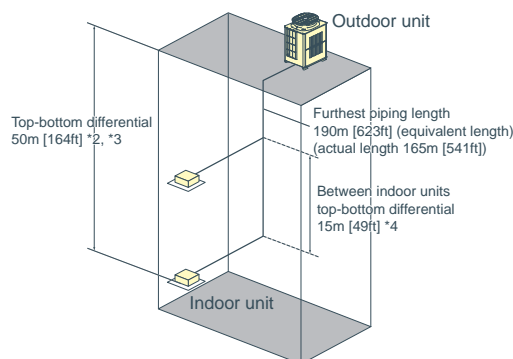

\*1 90m [295ft] is available. When the piping length exceeds 40m [131ft], use one size larger liquid pipe starting with the section of piping where 40m [131ft] is exceeded and all piping after that point.  
\*2 90m [295ft] is available depending on the model and installation conditions. For more detailed information, contact your local distributor.  
\*3 60m [196ft] is available depending on the model and installation conditions. For more detailed information, contact your local distributor.  
\*4 30m [98ft] is available. If the height difference between indoor units exceeds 15m [49ft] (but does not exceed 30m [98ft]), use one-size larger pipes for indoor unit liquid pipes.



Outdoor Unit



# R2 (Heat Recovery) series



## Simultaneous Cooling and Heating

R2 series — { PURY-P YLM-A(-BS)      PURY-EP YLM-A(-BS)  
 PURY-P YSLM-A(-BS)      PURY-EP YSLM-A(-BS)

### The world's first two-pipe system that Simultaneously Cools and Heats

CITY MULTI R2 series offers the ultimate in freedom and flexibility. Cool one zone while heating another. Our exclusive BC controller makes two-pipe simultaneous cooling and heating possible. The BC controller is the technological heart of the CITY MULTI R2 series. It houses a liquid and gas separator, allowing the outdoor unit to deliver a mixture of hot gas for heating and liquid for cooling, all through the same pipe. This innovation results in minimum energy wasted. Depending on capacity, up to 50 indoor units can be connected with up to 150% connected capacity.

Installation image (R2 series)

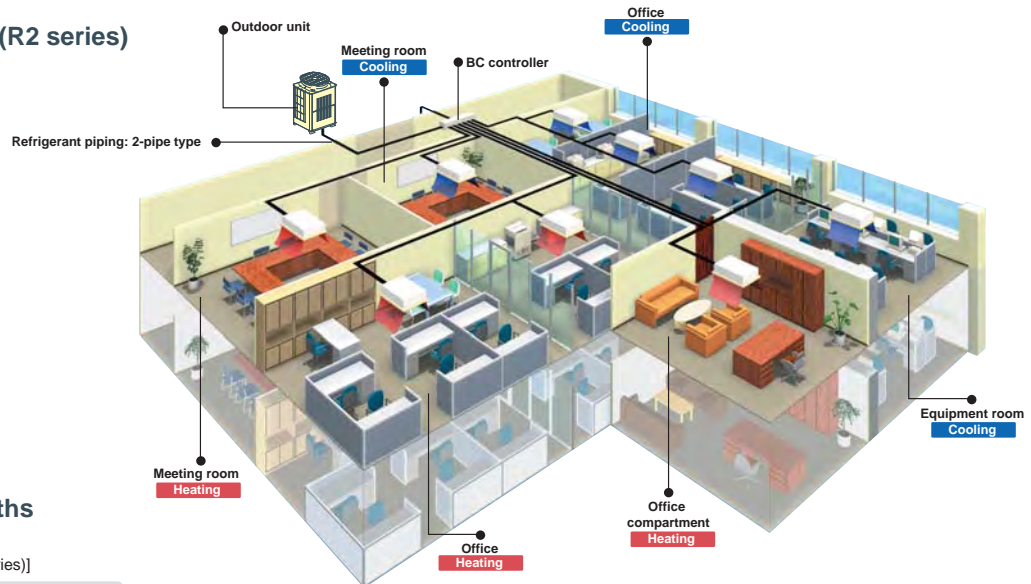

#### System Pipe Lengths

[22.4-101kW (R2 series)]  
 [22.4-101kW (High COP R2 series)]

Refrigerant Piping Lengths	Maximum meters [Feet]
Total length.....	550 [1,804]
((E)P600, 650 only)	
Total length.....	700 [2,296]
((E)P700, 750, 800, 850, 900 only)	
Maximum allowable length.....	165 (190equivalent) [541 (623)]
Maximum length between outdoor and single/main BC controller.....	110 [360]
*Maximum total length is dependent upon the distance between the outdoor unit and the single/main BC Controller.	
Maximum length between single/main BC controller and indoor.....	40-60 [131-196]
<b>Vertical differentials between units</b>	<b>Maximum meters [Feet]</b>
Indoor/outdoor (outdoor higher).....	50 [164]*2
Indoor/outdoor (outdoor lower).....	40 [131]*2
Indoor/BC controller (single/main).....	15 [49]
*Maximum length between single/main BC controller and indoor is dependent upon the vertical differential between the single/main BC controller and the indoor unit.	
Indoor/indoor.....	15 [49]
Main BC Controller/Sub BC Controller.....	15 [49]

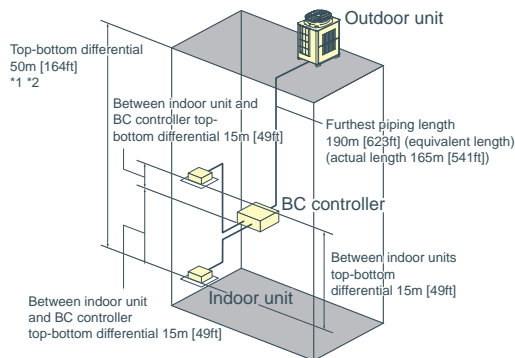

\*1 When the outdoor unit is installed below the indoor unit, top-bottom differential is 40m [131ft].

\*2 Depending on the model and installation conditions, top-bottom differential 90m [295ft] (o/u above) and 60m [196ft] (o/u below) is available. For more detailed information, please contact your nearest sales office or distributor.



# Features in Y (Heat Pump) series & R2 (Heat Recovery) series

## Compact Design

The manageability of the outdoor unit has been improved due to a drastic reduction in its weight, leading to easy transportation, installation, and reduction in withstand load.

28kW outdoor unit



233kg  
PUHY-P250YGM-A  
Previous Model

25kg  
reduction in weight



208kg  
PUHY-EP200YLM-A  
Current Model

## Space Saving

The downsized outdoor unit can be transported through a 800 mm wide door.

■ 22.4-28kW outdoor units mm (in.)

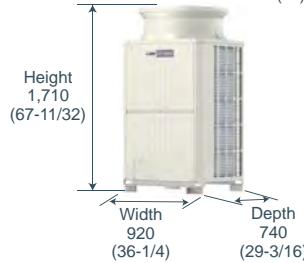

■ Example of 6-people elevator. mm (in.)

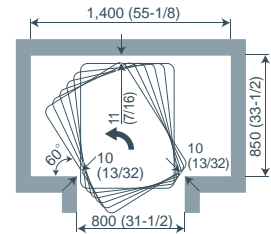

## Effective Use of Space

The new models have a smaller foot print and service space requirement than previous models.

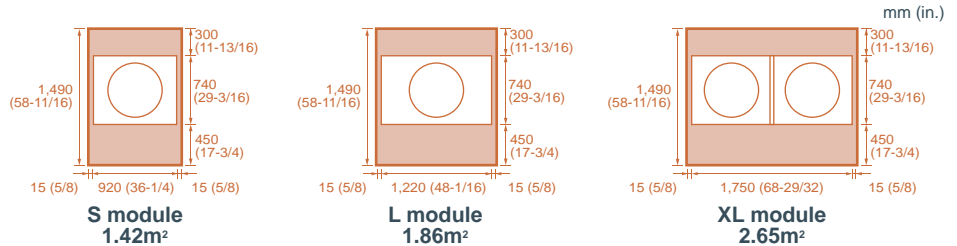

50kW (Yseries)

mm (in.)

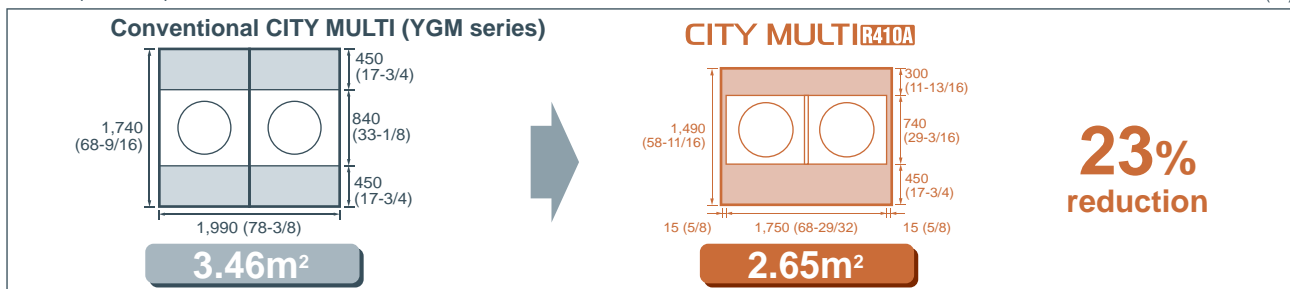

The unit can easily be transported even into slender buildings.

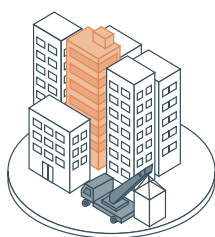

CITY MULTI makes it easy.

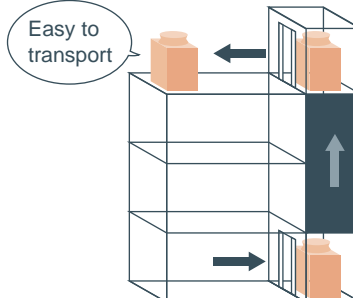

The narrow space between buildings makes it difficult to use a crane.



Outdoor Unit

## Low Noise Levels New Fan Design

CITY MULTI VRF systems led the introduction of larger single fan motors some ten years ago, achieving substantially lower noise levels over multiple designs. Continuing the development in the areas of blade shape and weight, Mitsubishi Electric have managed to achieve even higher performance and lower noise levels. To reduce noise levels further and comply with inner city residential noise regulations, all outdoor units include low noise mode. This function works by lowering the fan speed and compressor frequency proportionally with reduction in demand.

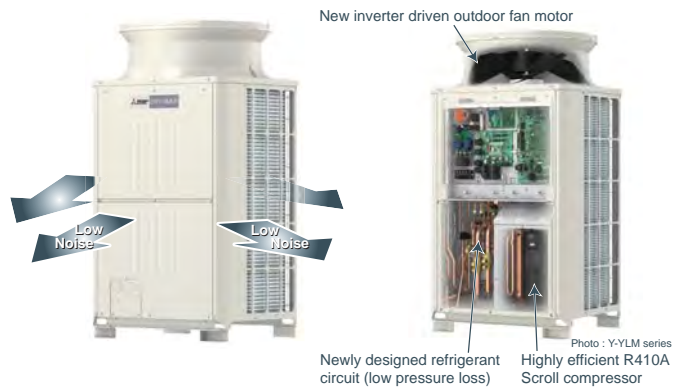

The compressor compartment is sealed by metal panels to attain low noise levels in all directions.

## R410A Pipe Sizing

As R410A has a higher specific heat capacity than R22, the pipework is smaller. This means the pipe itself is cheaper, easier to install and less riser space is required within the building.

Conventional		CITY MULTI R410A	
Gas piping	Liquid piping	Gas piping	Liquid piping
ø28.58 (ø1-1/8)	ø12.7 (ø1/2)	ø22.2 (ø7/8)	ø9.52 (ø3/8)

mm (in.)

Based on 10HP model

## Easy Maintenance

Even when one of the indoor units in the system is under maintenance, the other indoor unit can still operate.

- \* Not applicable to all situations.
- \* Be sure to turn off the power to the indoor unit when repairing or servicing the unit.

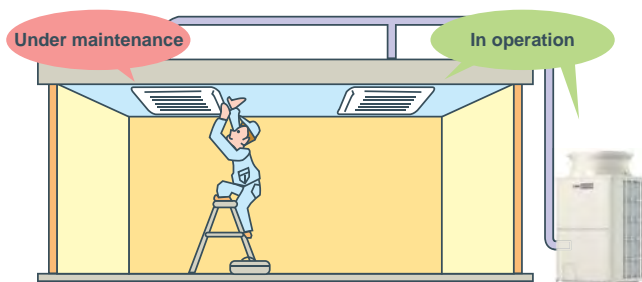

## Blue Fin Treatment (PUHY-P-YKB/ PURY-P-YLM only)

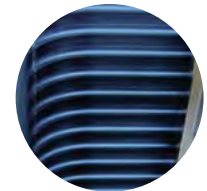

The anti-corrosion Blue Fin treatment of the heat exchanger is especially effective in urban environments where the traffic pollutions can damage the aluminum fins reducing the capacity and life expectancy of the unit. All standard CITY MULTI R410A outdoor units have been treated with Blue Fin.

- \*Standard:Anti-corrosion Blue Fin treatment & copper tube.
- BS type (optional):salt-resistant cross fin & copper tube.

## Salt resistant Cross Fin (PUHY/PURY-EP-Y(S)LM-A only)

For PUHY/PURY-EP-Y(S)LM-A with aluminum flat-tube heat exchanger, salt resistant cross fin is provided as standard.

## 60Pa High Static Pressure as standard

Both Y and R2 series correspond to high static pressure of 60Pa, ideal and flexible for any type of application.

## System Check

Ensuring simple and easy maintenance, system tests are available to check wiring, sensors and the refrigerant amount.

# Advanced Energy-saving Technologies



S series | PUMY-P VKM  
PUMY-P YKM

## Highly efficient fan and grille for outdoor unit

The shapes of the fan and grille of the outdoor unit have been redesigned, realising an increase in blowing capacity and more efficient heat exchange while maintaining the same operating noise level.

### Outdoor unit fan opening increased

The diameter of the opening for the fan in the outdoor unit has been increased from 490 to 550mm. Blowing capacity has been increased while maintaining the same fan rotation speed.

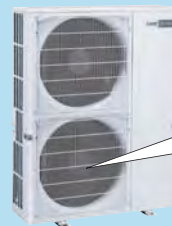

Opening increased from 490 to 550mm in diameter

### Grille shape changed

The shape of the air outlet grille has been changed to reduce pressure loss. This has helped to improve heat exchange performance.

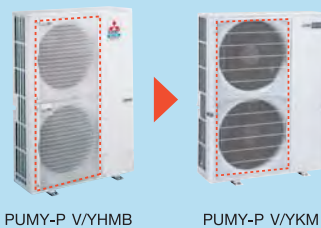

PUMY-P V/YHMB

PUMY-P V/YKM

### Inflexed fan

Adoption of a fan with improved ventilation characteristics and a newly designed rear edge that suppresses wind turbulence raises fan operation efficiency.

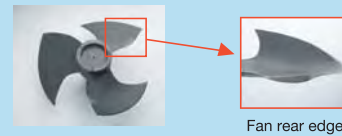

Fan rear edge

## Highly efficient heat exchanger

A high density and increase in surface area have improved the heat-exchange efficiency of the heat exchanger.

### High-density heat exchanger

The pipe diameter has been changed from 9.52 to 7.94mm, resulting in a high-density heat exchanger.

### Heat-exchange surface area increased

Heat exchanger size extended horizontally, increasing the surface area.

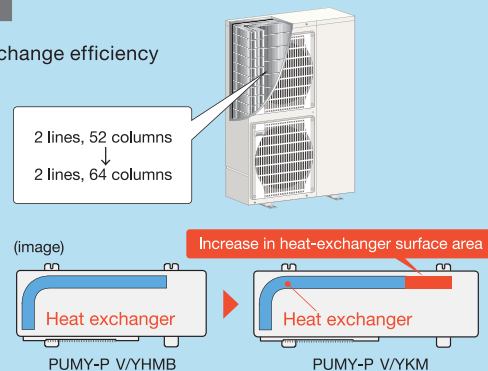

## Heat Interchanger (HIC) Added

A HIC circuit has been added to improve energy efficiency during cooling operation. Liquid refrigerant is rerouted, transformed into a gas state and injected back into the system to increase overall pressure of the refrigerant being sent to the compressor, thereby reducing the load on the compressor and raising efficiency.

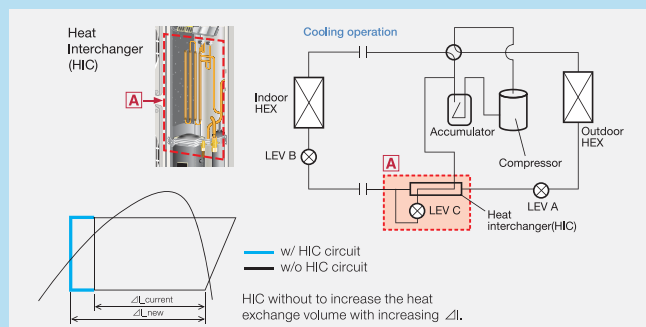



### Demand Response Capable

Demand Response mode is activated in response to signals sent from the electric power company at times when it is necessary to reduce peak demand.

### Light weight

Easy to transport and install at site.

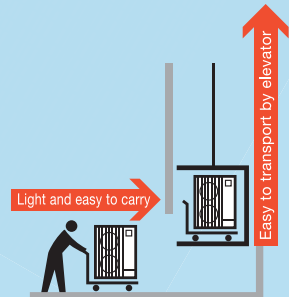
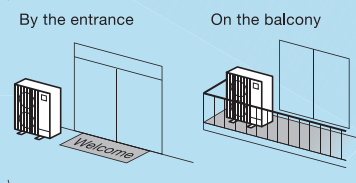

## The two-pipe zoned system designed for Heat Pump Operation

The CITY MULTI S series (for small applications) make use of a two-pipe refrigerant system, which allows for system changeover from cooling to heating, ensuring that a constant indoor climate is maintained in all zones. The compact outdoor unit utilizes R410A refrigerant and an INVERTER-driven compressor to use energy effectively.

With a wide range of indoor unit line-up in connection with a flexible piping system, the CITY MULTI series can be configured for all applications. Up to 12 (S series) indoor units can be connected with up to 130% connected capacity to maximize engineer's design options. This feature allows easy air conditioning in each area with convenient individual controllers.

### Small Offices

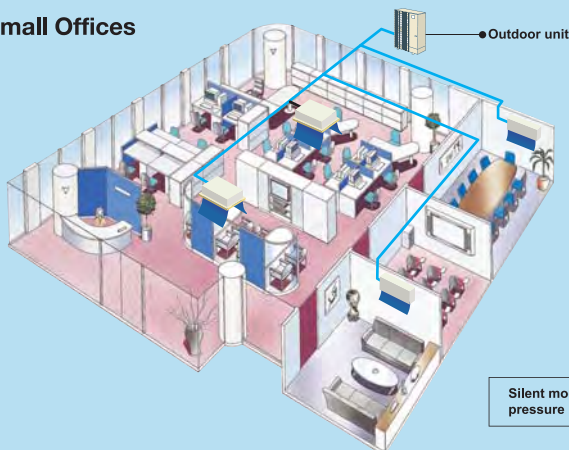

### Residence

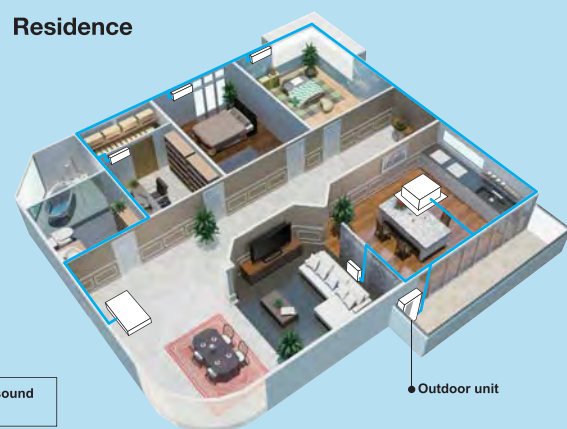

### [P112~140(V/YKM)]

Refrigerant Piping Lengths	Maximum meters [Feet]
Total length	300 [984]
Maximum allowable length	150 (175 equivalent) [492(574)]
Farthest indoor from first branch	30 [98]
Vertical differentials between units	Maximum meters [Feet]
Indoor/outdoor (outdoor higher)	50 [164]
Indoor/outdoor (outdoor lower)	40 [131]
Indoor/indoor	15 [49]

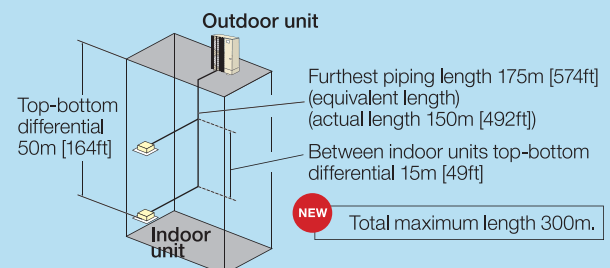

# Water Cooled Series



## Cooling or Heating

WY series — PQHY-P YHM-A  
PQHY-P YSHM-A

WR2 series — PQRy-P YHM-A  
PQRy-P YSHM-A

### [WY(Heat Pump) series]

## Water energy source system allows switching between cooling and heating.

The WY-Series has all the benefits of the Y-Series using water source condensing units. Condensing units can be situated indoors allowing greater design flexibility and no limitation on building size. Depending on capacity, 17 to 50 indoor units can be connected to a single condensing unit with individual and/or centralised control. The two-pipe system allows all CITY MULTI solutions to switch between cooling and heating while maintaining a constant indoor temperature.

### Installation image (WY series)

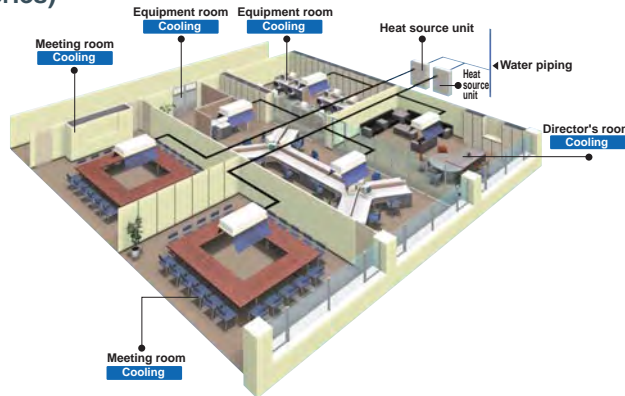

### [WR2(Heat Recovery) series]

## Advanced water heat source unit enjoying the benefits of R2 series

The CITY MULTI WR2 series provides all of the advantages of the R2 series with the added advantages of a water heat source system, making it suitable for wider range of applications in high rises, frigid climates, coastal areas, etc.

Not only does it produce heat recovery from the indoor units on the same 2-pipe refrigerant circuit, it also produces heat recovery via the water circuit between heat source units, making it a very economical system.

### Installation image (WR2 series)

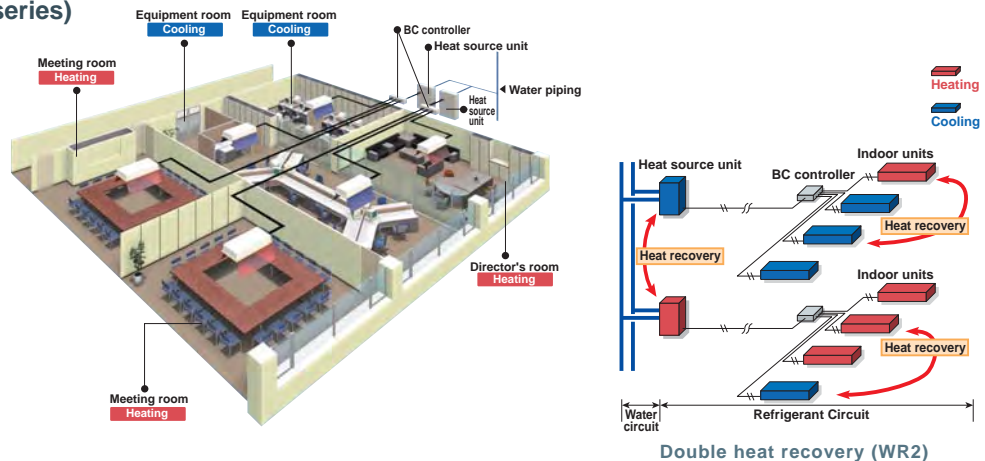

Outdoor Unit

### System Pipe Lengths

[22.4-101kW (WY series)]

Refrigerant Piping Lengths		Maximum meters [Feet]
Total length (22.4-33.5kW)		300 [984]
Total length (45-101kW)		500 [1,640]
Maximum allowable length		165 (190equivalent) [541 (623)]
Farthest indoor from first branch		40 [131]
Vertical differentials between units		Maximum meters [Feet]
Indoor/heat source (heat source higher)		50 [164]
Indoor/heat source (heat source lower)		40 [131]
Indoor/indoor		15 [49]

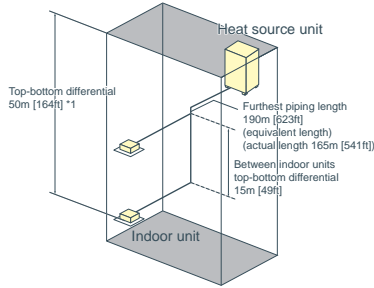

\*1 When the outdoor unit is installed below the indoor unit, top-bottom differential is 40m [131ft].

[22.4-69kW (WR2 series)]

Refrigerant Piping Lengths		Maximum meters [Feet]
Total length (22.4-33.5kW)		300-550 [984-1,804]
Total length (45-69kW)		500-750 [1,640-2,460]
Maximum allowable length		165 (190equivalent) [541 (623)]
Maximum length between heat source and single/main BC controller		110 [360]
*Maximum total length is dependent upon the distance between the outdoor unit and the single/main BC Controller.		
Maximum length between single/main BC controller and indoor		40-60 [131-196]
Vertical differentials between units		Maximum meters [Feet]
Indoor/ heat source ( heat source higher)		50 [164]
Indoor/ heat source ( heat source lower)		40 [131]
Indoor/BC controller (single/main)		15 [49]
Indoor/indoor		15 (10) [49 (32)]
Main BC Controller/Sub BC Controller		15 (10) [49 (32)]

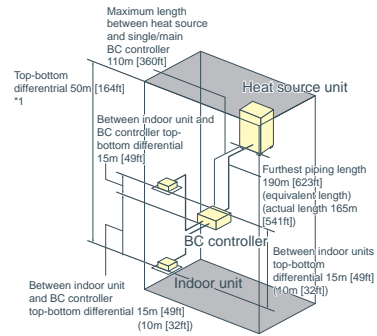

\*1 When the outdoor unit is installed below the indoor unit, top-bottom differential is 40m [131ft].

## COP comparison (energy efficiency)

The current water cooled outdoor unit offers a greater efficiency with a higher COP compared to our YGM conventional model.

### COP comparison

		kW		22.4	28.0	33.5	45.0	50.0	56.0	63.0	69.0	73.0	80.0	85.0	90.0	96.0	101.0	
PQHY	YGM	Cooling	4.68	4.71	-	3.96	-	3.72	-	-	-	-	-	-	-	-	-	-
		Heating	4.68	4.71	-	3.96	-	3.72	-	-	-	-	-	-	-	-	-	-
	YHM	Cooling	5.71	5.13	4.55	5.45	5.08	4.89	4.68	4.45	5.22	5.13	4.94	4.69	4.52	4.34	-	-
		Heating	6.06	5.43	4.60	5.78	5.37	5.22	4.70	4.46	5.52	5.33	5.19	4.82	4.65	4.40	-	-
PQRY	YGM	Cooling	4.68	4.71	-	3.96	-	3.72	-	-	-	-	-	-	-	-	-	-
		Heating	5.33	5.43	-	4.54	-	4.63	-	-	-	-	-	-	-	-	-	-
	YHM	Cooling	5.65	5.08	4.50	5.40	5.03	4.84	4.63	4.41	-	-	-	-	-	-	-	-
		Heating	6.06	5.43	4.60	5.78	5.37	5.22	4.70	4.46	-	-	-	-	-	-	-	-

## Compact design

Downsized by approximately 57%\*, the current models enable an effective use of space.

\*22.4/28.0/33.5kW

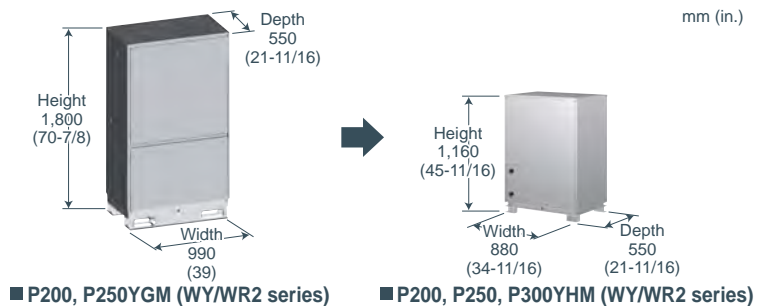

## Weight saving

The reduction in weight leads to easy transportaion and installation.

### Weight comparison

		kW		22.4	28.0	33.5	45.0	50.0	56.0	63.0	69.0	73.0	80.0	85.0	90.0	96.0	101.0
PQHY	YGM			272	275	-	452	-	456	-	-	-	-	-	-	-	585
	YHM			195	195	195	390	390	390	390	390	585	585	585	585	585	-
PQRY	YGM			263	266	-	440	-	444	-	-	-	-	-	-	-	-
	YHM			181	181	181	362	362	362	362	362	-	-	-	-	-	-

# OUTDOOR UNIT

## S Series

### PUMY-P VKM-A(-BS)



#### ► Specifications

Model	PUMY-P112VKM-A (-BS)		PUMY-P125VKM-A (-BS)		PUMY-P140VKM-A (-BS)	
Power source	1-phase 230V 50Hz		1-phase 230V 50Hz		1-phase 230V 50Hz	
Cooling capacity (Nominal)	*1	kW	12.5	14.0	15.5	
	*1	BTU / h	42,700	47,800	52,900	
		Power input kW	2.79	3.46	4.52	
		Current input A	12.32	15.27	19.95	
		AEER/EER	kW / kW	4.13/4.48	3.76/4.05	3.22/3.43
Temp. range of cooling	Indoor temp.	W.B.	15.0~24.0°C(59~75°F)		15.0~24.0°C(59~75°F)	
	Outdoor temp.	D.B.	-5.0~46.0°C(23~115°F)		-5.0~46.0°C(23~115°F)	
Heating capacity (Nominal)	*2	kW	14.0	16.0	18.0	
	*2	BTU / h	47,800	54,600	61,400	
		Power input kW	3.13	3.74	4.47	
		Current input A	13.82	16.51	19.73	
		ACOP/COP	kW / kW	4.20/4.47	4.03/4.28	3.81/4.03
Temp. range of heating	Indoor temp.	D.B.	15.0~27.0°C(59~81°F)		15.0~27.0°C(59~81°F)	
	Outdoor temp.	W.B.	-20.0°C(-4°F)		-20.0°C(-4°F)	
Indoor unit connectable	Total capacity	50~130 % of outdoor unit capacity		50~130 % of outdoor unit capacity		
	Model / Quantity	P15~P140/9		P15~P140/10		
Sound pressure level (measured in anechoic room)	dB <A>	49/51		50/52		
Refrigerant piping diameter	Liquid pipe	9.52(3/8) Flare		9.52(3/8) Flare		
	Gas pipe	15.88(5/8) Flare		15.88(5/8) Flare		
FAN	Type x Quantity	Propeller Fan x 2		Propeller Fan x 2		
	Air flow rate	m <sup>3</sup> /min	110		120	
		L/s	1,833		2,000	
		cfm	3,884		4,237	
	Motor output	kW		0.06 + 0.06		
Compressor	Type x Quantity	Scroll hermetic compressor x 1		Scroll hermetic compressor x 1		
	Starting method	Inverter		Inverter		
	Motor output	kW		3.0		
External finish	Galvanized Steel Sheet Munsell No. 3Y 7.8/1.1		Galvanized Steel Sheet Munsell No. 3Y 7.8/1.1		Galvanized Steel Sheet Munsell No. 3Y 7.8/1.1	
External dimension HxWxD	mm	1,338 x 1,050 x 330 (+25)		1,338 x 1,050 x 330 (+25)		
	in.	52-11/16 x 41-11/32 x 13 (+1)		52-11/16 x 41-11/32 x 13 (+1)		
Protection devices	High pressure protection	High pressure Switch		High pressure Switch		
	Inverter circuit (COMP/FAN)	Overcurrent detection, Overheat detection (Heatsink thermistor)		Overcurrent detection, Overheat detection (Heatsink thermistor)		
	Compressor	Compressor thermistor, Over current detection		Compressor thermistor, Over current detection		
	Fan motor	Overheating, Voltage protection		Overheating, Voltage protection		
Refrigerant	Type x original charge	R410A 4.8kg		R410A 4.8kg		
Net weight	kg (lbs)	123(272)		123(272)		
Heat exchanger	Plate fin coil		Plate fin coil		Plate fin coil	
Defrosting method	Reversed refrigerant circuit		Reversed refrigerant circuit		Reversed refrigerant circuit	
Optional parts	Joint: CMY-Y62-G-E Header: CMY-Y64/68-G-E		Joint: CMY-Y62-G-E Header: CMY-Y64/68-G-E		Joint: CMY-Y62-G-E Header: CMY-Y64/68-G-E	

#### Notes:

\*1,\*2 Nominal conditions

	Indoor	Outdoor	Pipe length	Level difference
Cooling	27°C DB/19°C WB (81°F DB/66°F WB)	35°C DB(95°F DB)	7.5m (24-9/16ft.)	0m (0ft.)
Heating	20°C DB(68°F DB)	7°C DB/6°C WB(45°F DB/43°F WB)	7.5m (24-9/16ft.)	0m (0ft.)

\*Nominal condition \*1,\*2 are subject to ISO 15042.

\*Due to continuing improvement, above specification may be subject to change without notice.





# OUTDOOR UNIT

## S Series

### PUMY-P YKM-A(-BS)



#### ► Specifications

Model	PUMY-P112YKM-A (-BS)		PUMY-P125YKM-A (-BS)		PUMY-P140YKM-A (-BS)	
Power source	3-phase 400V 50Hz		3-phase 400V 50Hz		3-phase 400V 50Hz	
Cooling capacity (Nominal)	*1	kW	12.5	14.0	15.5	
	*1	BTU / h	42,700	47,800	52,900	
		Power input kW	2.79	3.46	4.52	
		Current input A	4.24	5.26	6.87	
		AEER/EER	kW / kW	4.07/4.48	3.71/4.05	3.19/3.43
Temp. range of cooling	Indoor temp.	W.B.	15.0~24.0°C(59~75°F)	15.0~24.0°C(59~75°F)	15.0~24.0°C(59~75°F)	
	Outdoor temp.	D.B.	-5.0~46.0°C(23~115°F)	-5.0~46.0°C(23~115°F)	-5.0~46.0°C(23~115°F)	
Heating capacity (Nominal)	*2	kW	14.0	16.0	18.0	
	*2	BTU / h	47,800	54,600	61,400	
		Power input kW	3.13	3.74	4.47	
		Current input A	4.76	5.68	6.79	
		ACOP/COP	kW / kW	4.14/4.47	3.99/4.28	3.78/4.03
Temp. range of heating	Indoor temp.	D.B.	15.0~27.0°C(59~81°F)	15.0~27.0°C(59~81°F)	15.0~27.0°C(59~81°F)	
	Outdoor temp.	W.B.	-20.0°C(-4°F)	-20.0°C(-4°F)	-20.0°C(-4°F)	
Indoor unit connectable	Total capacity	50~130 % of outdoor unit capacity		50~130 % of outdoor unit capacity		
	Model / Quantity	P15~P140/9		P15~P140/10		
Sound pressure level (measured in anechoic room)	dB <A>	49/51		50/52		
Refrigerant piping diameter	Liquid pipe	9.52(3/8) Flare		9.52(3/8) Flare		
	Gas pipe	15.88(5/8) Flare		15.88(5/8) Flare		
FAN	Type x Quantity	Propeller Fan x 2		Propeller Fan x 2		
	Air flow rate	m <sup>3</sup> /min	110	110	120	
		L/s	1,833	1,833	2,000	
		cfm	3,884	3,884	4,237	
	Motor output	kW	0.06 + 0.06	0.06 + 0.06	0.06 + 0.06	
Compressor	Type x Quantity	Scroll hermetic compressor x 1		Scroll hermetic compressor x 1		
	Starting method	Inverter		Inverter		
	Motor output	kW	3.0	3.5	4.0	
External finish	Galvanized Steel Sheet Munsell No. 3Y 7.8/1.1		Galvanized Steel Sheet Munsell No. 3Y 7.8/1.1		Galvanized Steel Sheet Munsell No. 3Y 7.8/1.1	
External dimension HxWxD	mm	1,338 x 1,050 x 330 (+25)		1,338 x 1,050 x 330 (+25)		
	in.	52-11/16 x 41-11/32 x 13 (+1)		52-11/16 x 41-11/32 x 13 (+1)		
Protection devices	High pressure protection	High pressure Switch		High pressure Switch		
	Inverter circuit (COMP/FAN)	Overcurrent detection, Overheat detection (Heatsink thermistor)		Overcurrent detection, Overheat detection (Heatsink thermistor)		
	Compressor	Compressor thermistor, Over current detection		Compressor thermistor, Over current detection		
	Fan motor	Overheating, Voltage protection		Overheating, Voltage protection		
Refrigerant	Type x original charge	R410A 4.8kg		R410A 4.8kg		
Net weight	kg (lbs)	125(276)		125(276)		
Heat exchanger	Plate fin coil		Plate fin coil		Plate fin coil	
Defrosting method	Reversed refrigerant circuit		Reversed refrigerant circuit		Reversed refrigerant circuit	
Optional parts	Joint: CMY-Y62-G-E Header: CMY-Y64/68-G-E		Joint: CMY-Y62-G-E Header: CMY-Y64/68-G-E		Joint: CMY-Y62-G-E Header: CMY-Y64/68-G-E	

#### Notes:

\*1,\*2 Nominal conditions

	Indoor	Outdoor	Pipe length	Level difference
Cooling	27°C DB/19°C WB (81°F DB/66°F WB)	35°C DB(95°F DB)	7.5m (24-9/16ft.)	0m (0ft.)
Heating	20°C DB(68°F DB)	7°C DB/6°C WB(45°F DB/43°F WB)	7.5m (24-9/16ft.)	0m (0ft.)

\*Nominal condition \*1,\*2 are subject to ISO 15042.

\*Due to continuing improvement, above specification may be subject to change without notice.



# OUTDOOR UNIT

## Y Series

### PUHY-P YKB-A(-BS)



## ► Specifications

Model		PUHY-P200YKB-A (-BS)	PUHY-P250YKB-A (-BS)	
Power source		3-phase 4-wire 380-400-415 V 50/60 Hz	3-phase 4-wire 380-400-415 V 50/60 Hz	
Cooling capacity (Nominal)	*1 kW	22.4	28.0	
	*1 BTU / h	76,400	95,500	
	Power input kW	6.12	8.09	
	Current input A	10.3-9.8-9.4	13.6-12.9-12.5	
EER		3.66	3.46	
Temp. range of cooling	Indoor W.B.	15.0-24.0°C (59-75°F)	15.0-24.0°C (59-75°F)	
	Outdoor D.B.	-5.0-52.0°C (23-126°F)	-5.0-52.0°C (23-126°F)	
Heating capacity (Nominal)	*2 kW	25.0	31.5	
	*2 BTU / h	85,300	107,500	
	Power input kW	6.15	8.33	
	Current input A	10.3-9.8-9.5	14.0-13.3-12.8	
COP		4.06	3.78	
Temp. range of heating	Indoor D.B.	15.0-27.0°C (59-81°F)	15.0-27.0°C (59-81°F)	
	Outdoor W.B.	-20.0-15.5°C (-4-60°F)	-20.0-15.5°C (-4-60°F)	
Indoor unit connectable	Total capacity	50-130% of outdoor unit capacity	50-130% of outdoor unit capacity	
Model / Quantity		P15-P250/1-17	P15-P250/1-21	
Sound pressure level (measured in anechoic room)	dB <A>	57	59	
Sound power level (measured in anechoic room)	dB <A>	78	79	
Refrigerant piping diameter	Liquid pipe mm (in.)	9.52 (3/8) Brazed	9.52 (3/8) Brazed (12.7 (1/2) Brazed, farthest length >= 90 m)	
	Gas pipe mm (in.)	22.2 (7/8) Brazed	22.2 (7/8) Brazed	
FAN	Type x Quantity	Propeller fan x 1	Propeller fan x 1	
	Air flow rate	m <sup>3</sup> /min	175	175
		L/s	2,917	2,917
		cfm	6,179	6,179
	Driving mechanism	Inverter-control, Direct-driven by motor	Inverter-control, Direct-driven by motor	
	Motor output kW	0.92 x 1	0.92 x 1	
*3 External static press.	0 Pa (0 mmH <sub>2</sub> O)	0 Pa (0 mmH <sub>2</sub> O)		
Compressor	Type x Quantity	Inverter scroll hermetic compressor	Inverter scroll hermetic compressor	
	Starting method	Inverter	Inverter	
	Motor output kW	5.5	6.9	
	Case heater kW	-	-	
External finish		Pre-coated galvanized steel sheets (+powder coating for -BS type) <MUNSELL 5Y 8/1 or similar>	Pre-coated galvanized steel sheets (+powder coating for -BS type) <MUNSELL 5Y 8/1 or similar>	
External dimension HxWxD	mm	1,710 (1,650 without legs) x 920 x 740	1,710 (1,650 without legs) x 920 x 740	
	in.	67-3/8 (65 without legs) x 36-1/4 x 29-3/16	67-3/8 (65 without legs) x 36-1/4 x 29-3/16	
Protection devices	High pressure protection	High pressure sensor, High pressure switch at 4.15 MPa (601 psi)	High pressure sensor, High pressure switch at 4.15 MPa (601 psi)	
	Inverter circuit (COMP/FAN)	Over-heat protection, Over-current protection	Over-heat protection, Over-current protection	
	Compressor	Over-heat protection	Over-heat protection	
	Fan motor	Over-current protection	Over-current protection	
Refrigerant	Type x original charge	R410A x 6.5 kg (15 lbs)	R410A x 8.0 kg (18 lbs)	
Net weight	kg (lbs)	190 (419)	199 (439)	
Heat exchanger		Salt-resistant cross fin & copper tube	Salt-resistant cross fin & copper tube	
Optional parts		Joint: CMY-Y102SS/LS-G2 Header: CMY-Y104/108/1010-G	Joint: CMY-Y102SS/LS-G2 Header: CMY-Y104/108/1010-G	

### Notes:

\*1,\*2 Nominal conditions

	Indoor	Outdoor	Pipe length	Level difference
Cooling	27°C DB/19°C WB (81°F DB/66°F WB)	35°C DB/24°C WB (95°F DB/75°F WB)	7.5m (24-9/16ft.)	0m (0ft.)
Heating	20°C DB(68°F DB)	7°C DB/6°C WB(45°F DB/43°F WB)	7.5m (24-9/16ft.)	0m (0ft.)

\*3 External static pressure option is available (30Pa, 60Pa / 3.1mmH<sub>2</sub>O, 6.1mmH<sub>2</sub>O).

\*Nominal condition \*1,\*2 are subject to JIS B8615-1.

\*Due to continuing improvement, above specification may be subject to change without notice.



# OUTDOOR UNIT

## Y Series

### PUHY-P YKB-A(-BS)



## ► Specifications

Model		PUHY-P300YKB-A (-BS)		PUHY-P350YKB-A (-BS)		
Power source		3-phase 4-wire 380-400-415 V 50/60 Hz		3-phase 4-wire 380-400-415 V 50/60 Hz		
Cooling capacity (Nominal)	*1 kW	33.5		40.0		
	*1 BTU / h	114,300		136,500		
	Power input kW	9.49		11.79		
	Current input A	16.0-15.2-14.6		19.9-18.9-18.2		
EER	kW / kW	3.53		3.39		
Temp. range of cooling	Indoor W.B.	15.0~24.0°C (59~75°F)		15.0~24.0°C (59~75°F)		
	Outdoor D.B.	-5.0~52.0°C (23~126°F)		-5.0~52.0°C (23~126°F)		
Heating capacity (Nominal)	*2 kW	37.5		45.0		
	*2 BTU / h	128,000		153,500		
	Power input kW	9.89		13.23		
	Current input A	16.6-15.8-15.2		22.3-21.2-20.4		
COP	kW / kW	3.79		3.40		
Temp. range of heating	Indoor D.B.	15.0~27.0°C (59~81°F)		15.0~27.0°C (59~81°F)		
	Outdoor W.B.	-20.0~15.5°C (-4~60°F)		-20.0~15.5°C (-4~60°F)		
Indoor unit connectable	Total capacity	50~130% of outdoor unit capacity		50~130% of outdoor unit capacity		
	Model / Quantity	P15~P250/1~26		P15~P250/1~30		
Sound pressure level (measured in anechoic room)	dB <A>	61		61		
Sound power level (measured in anechoic room)	dB <A>	83		83		
Refrigerant piping diameter	Liquid pipe mm (in.)	9.52 (3/8) Brazed (12.7 (1/2) Brazed, farthest length >= 40 m)		12.7 (1/2) Brazed		
	Gas pipe mm (in.)	22.2 (7/8) Brazed		28.58 (1-1/8) Brazed		
FAN	Type x Quantity	Propeller fan x 1		Propeller fan x 1		
	Air flow rate	m <sup>3</sup> /min	210		210	
		L/s	3,500		3,500	
		cfm	7,415		7,415	
	Driving mechanism	Inverter-control, Direct-driven by motor		Inverter-control, Direct-driven by motor		
	Motor output	kW	0.92 x 1		0.92 x 1	
*3 External static press.		0 Pa (0 mmH <sub>2</sub> O)		0 Pa (0 mmH <sub>2</sub> O)		
Compressor	Type x Quantity	Inverter scroll hermetic compressor		Inverter scroll hermetic compressor		
	Starting method	Inverter		Inverter		
	Motor output	kW	8.1		10.5	
	Case heater	kW	-		-	
External finish		Pre-coated galvanized steel sheets (+powder coating for -BS type) <MUNSELL 5Y 8/1 or similar>		Pre-coated galvanized steel sheets (+powder coating for -BS type) <MUNSELL 5Y 8/1 or similar>		
External dimension HxWxD	mm	1,710 (1,650 without legs) x 1,220 x 740		1,710 (1,650 without legs) x 1,220 x 740		
	in.	67-3/8 (65 without legs) x 48-1/16 x 29-3/16		67-3/8 (65 without legs) x 48-1/16 x 29-3/16		
Protection devices	High pressure protection	High pressure sensor, High pressure switch at 4.15 MPa (601 psi)		High pressure sensor, High pressure switch at 4.15 MPa (601 psi)		
	Inverter circuit (COMP/FAN)	Over-heat protection, Over-current protection		Over-heat protection, Over-current protection		
	Compressor	Over-heat protection		Over-heat protection		
	Fan motor	Over-current protection		Over-current protection		
Refrigerant	Type x original charge	R410A x 11.5 kg (26 lbs)		R410A x 11.5 kg (26 lbs)		
Net weight	kg (lbs)	251 (554)		251 (554)		
Heat exchanger		Salt-resistant cross fin & aluminium tube		Salt-resistant cross fin & copper tube		
Optional parts		Joint: CMY-Y102SS/LS-G2 Header: CMY-Y104/108/1010-G		Joint: CMY-Y102SS/LS-G2,CMY-Y202S-G2 Header: CMY-Y104/108/1010-G		

### Notes:

\*1,\*2 Nominal conditions

	Indoor	Outdoor	Pipe length	Level difference
Cooling	27°C DB/19°C WB (81°F DB/66°F WB)	35°C DB/24°C WB (95°F DB/75°F WB)	7.5m (24-9/16ft.)	0m (0ft.)
Heating	20°C DB(68°F DB)	7°C DB/6°C WB(45°F DB/43°F WB)	7.5m (24-9/16ft.)	0m (0ft.)

\*3 External static pressure option is available (30Pa, 60Pa / 3.1mmH<sub>2</sub>O, 6.1mmH<sub>2</sub>O).

\*Nominal condition \*1,\*2 are subject to JIS B8615-1.

\*Due to continuing improvement, above specification may be subject to change without notice.



# OUTDOOR UNIT

## Y Series

### PUHY-P YSKB-A(-BS)



## ► Specifications

Model	PUHY-P400YSKB-A (-BS)		PUHY-P450YSKB-A (-BS)		PUHY-P500YSKB-A (-BS)		
Power source	3-phase 4-wire 380-400-415 V 50/60 Hz		3-phase 4-wire 380-400-415 V 50/60 Hz		3-phase 4-wire 380-400-415 V 50/60 Hz		
Cooling capacity (Nominal)	*1 kW	45.0	50.0	56.0	56.0	56.0	
	*1 BTU / h	153,500	170,600	191,100	191,100	191,100	
	Power input kW	12.96	14.74	16.91	16.91	16.91	
	Current input A	21.8-20.7-20.0	24.8-23.6-22.7	28.5-27.1-26.1	28.5-27.1-26.1	28.5-27.1-26.1	
EER	kW / kW	3.47	3.39	3.31	3.31	3.31	
	W.B.	15.0~24.0°C (59~75°F)	15.0~24.0°C (59~75°F)	15.0~24.0°C (59~75°F)	15.0~24.0°C (59~75°F)	15.0~24.0°C (59~75°F)	
Temp. range of cooling	D.B.	-5.0~52.0°C (23~126°F)	-5.0~52.0°C (23~126°F)	-5.0~52.0°C (23~126°F)	-5.0~52.0°C (23~126°F)	-5.0~52.0°C (23~126°F)	
	W.B.	-5.0~52.0°C (23~126°F)	-5.0~52.0°C (23~126°F)	-5.0~52.0°C (23~126°F)	-5.0~52.0°C (23~126°F)	-5.0~52.0°C (23~126°F)	
Heating capacity (Nominal)	*2 kW	50.0	56.0	63.0	63.0	63.0	
	*2 BTU / h	170,600	191,100	215,000	215,000	215,000	
	Power input kW	12.98	15.05	17.54	17.54	17.54	
	Current input A	21.9-20.8-20.0	25.4-24.1-23.2	29.6-28.1-27.1	29.6-28.1-27.1	29.6-28.1-27.1	
COP	kW / kW	3.85	3.72	3.59	3.59	3.59	
	D.B.	15.0~27.0°C (59~81°F)	15.0~27.0°C (59~81°F)	15.0~27.0°C (59~81°F)	15.0~27.0°C (59~81°F)	15.0~27.0°C (59~81°F)	
Temp. range of heating	W.B.	-20.0~15.5°C (-4~60°F)	-20.0~15.5°C (-4~60°F)	-20.0~15.5°C (-4~60°F)	-20.0~15.5°C (-4~60°F)	-20.0~15.5°C (-4~60°F)	
	D.B.	-20.0~15.5°C (-4~60°F)	-20.0~15.5°C (-4~60°F)	-20.0~15.5°C (-4~60°F)	-20.0~15.5°C (-4~60°F)	-20.0~15.5°C (-4~60°F)	
Indoor unit connectable	Total capacity	50~130% of outdoor unit capacity	50~130% of outdoor unit capacity	50~130% of outdoor unit capacity	50~130% of outdoor unit capacity	50~130% of outdoor unit capacity	
	Model / Quantity	P15~P250/1~34	P15~P250/1~39	P15~P250/1~43	P15~P250/1~43	P15~P250/1~43	
Sound pressure level (measured in anechoic room)	dB <A>	60	61.5	62	62	62	
Sound power level (measured in anechoic room)	dB <A>	81	82	82	82	82	
Refrigerant piping diameter	Liquid pipe mm (in.)	12.7 (1/2) Brazed	15.88 (5/8) Brazed	15.88 (5/8) Brazed	15.88 (5/8) Brazed	15.88 (5/8) Brazed	
	Gas pipe mm (in.)	28.58 (1-1/8) Brazed	28.58 (1-1/8) Brazed	28.58 (1-1/8) Brazed	28.58 (1-1/8) Brazed	28.58 (1-1/8) Brazed	
<b>Set Model</b>							
Model	PUHY-P200YKB-A (-BS)		PUHY-P200YKB-A (-BS)		PUHY-P250YKB-A (-BS)		
FAN	Type x Quantity	Propeller fan x 1	Propeller fan x 1	Propeller fan x 1	Propeller fan x 1	Propeller fan x 1	
	Air flow rate	m <sup>3</sup> /min	175	175	175	175	175
		L/s	2,917	2,917	2,917	2,917	2,917
		cfm	6,179	6,179	6,179	6,179	6,179
Driving mechanism	Inverter-control, Direct-driven by motor		Inverter-control, Direct-driven by motor		Inverter-control, Direct-driven by motor		
Motor output	kW	0.92 x 1	0.92 x 1	0.92 x 1	0.92 x 1	0.92 x 1	
	External static press.	0 Pa (0 mmH <sub>2</sub> O)	0 Pa (0 mmH <sub>2</sub> O)	0 Pa (0 mmH <sub>2</sub> O)	0 Pa (0 mmH <sub>2</sub> O)	0 Pa (0 mmH <sub>2</sub> O)	
Compressor	Type x Quantity	Inverter scroll hermetic compressor		Inverter scroll hermetic compressor		Inverter scroll hermetic compressor	
	Starting method	Inverter	Inverter	Inverter	Inverter	Inverter	
	Motor output kW	5.5	5.5	5.5	6.9	6.9	
	Case heater kW	—	—	—	—	—	
External finish	Pre-coated galvanized steel sheets (+powder coating for -BS type) <MUNSELL 5Y 8/1 or similar>		Pre-coated galvanized steel sheets (+powder coating for -BS type) <MUNSELL 5Y 8/1 or similar>		Pre-coated galvanized steel sheets (+powder coating for -BS type) <MUNSELL 5Y 8/1 or similar>		
External dimension HxWxD	mm	1,710 (1,650 without legs) x 920 x 740	1,710 (1,650 without legs) x 920 x 740	1,710 (1,650 without legs) x 920 x 740	1,710 (1,650 without legs) x 920 x 740	1,710 (1,650 without legs) x 920 x 740	
	in.	67-3/8 (65 without legs) x 36-1/4 x 29-3/16	67-3/8 (65 without legs) x 36-1/4 x 29-3/16	67-3/8 (65 without legs) x 36-1/4 x 29-3/16	67-3/8 (65 without legs) x 36-1/4 x 29-3/16	67-3/8 (65 without legs) x 36-1/4 x 29-3/16	
Protection devices	High pressure protection	High pressure sensor, High pressure switch at 4.15 MPa (601 psi)		High pressure sensor, High pressure switch at 4.15 MPa (601 psi)		High pressure sensor, High pressure switch at 4.15 MPa (601 psi)	
	Inverter circuit (COMP/FAN)	Over-heat protection, Over-current protection		Over-heat protection, Over-current protection		Over-heat protection, Over-current protection	
	Compressor	Over-heat protection		Over-heat protection		Over-heat protection	
	Fan motor	Over-current protection		Over-current protection		Over-current protection	
Refrigerant	Type x original charge	R410A x 6.5 kg (15 lbs)	R410A x 6.5 kg (15 lbs)	R410A x 6.5 kg (15 lbs)	R410A x 8.0 kg (18 lbs)	R410A x 8.0 kg (18 lbs)	
Net weight	kg (lbs)	190 (419)	190 (419)	190 (419)	199 (439)	199 (439)	
Heat exchanger	Salt-resistant cross fin & copper tube		Salt-resistant cross fin & copper tube		Salt-resistant cross fin & copper tube		
Pipe between unit and distributor	Liquid pipe mm (in.)	9.52 (3/8) Brazed	9.52 (3/8) Brazed	9.52 (3/8) Brazed	9.52 (3/8) Brazed	9.52 (3/8) Brazed	
	Gas pipe mm (in.)	22.2 (7/8) Brazed	22.2 (7/8) Brazed	22.2 (7/8) Brazed	22.2 (7/8) Brazed	22.2 (7/8) Brazed	
Optional parts	Outdoor Twinning kit: CMY-Y100VBK3 Joint: CMY-Y102SS/LS-G2, CMY-Y202S/302S-G2 Header: CMY-Y104/108/1010-G		Outdoor Twinning kit: CMY-Y100VBK3 Joint: CMY-Y102SS/LS-G2, CMY-Y202S/302S-G2 Header: CMY-Y104/108/1010-G		Outdoor Twinning kit: CMY-Y100VBK3 Joint: CMY-Y102SS/LS-G2, CMY-Y202S/302S-G2 Header: CMY-Y104/108/1010-G		

### Notes:

\*1,\*2 Nominal conditions

	Indoor	Outdoor	Pipe length	Level difference
Cooling	27°C DB/19°C WB (81°F DB/66°F WB)	35°C DB/24°C WB (95°F DB/75°F WB)	7.5m (24-9/16ft.)	0m (0ft.)
Heating	20°C DB/68°F DB)	7°C DB/6°C WB(45°F DB/43°F WB)	7.5m (24-9/16ft.)	0m (0ft.)

\*3 External static pressure option is available (30Pa, 60Pa / 3.1mmH<sub>2</sub>O, 6.1mmH<sub>2</sub>O).

\*Nominal condition \*1,\*2 are subject to JIS B8615-1.

\*Due to continuing improvement, above specification may be subject to change without notice.



Outdoor Unit

# OUTDOOR UNIT

## Y Series

### PUHY-P YSKB-A(-BS)



## ► Specifications

Model		PUHY-P550YSKB-A (-BS)		PUHY-P600YSKB-A (-BS)		PUHY-P650YSKB-A (-BS)		
Power source		3-phase 4-wire 380-400-415 V 50/60 Hz		3-phase 4-wire 380-400-415 V 50/60 Hz		3-phase 4-wire 380-400-415 V 50/60 Hz		
Cooling capacity (Nominal)	*1 kW	63.0		69.0		73.0		
	*1 BTU / h	215,000		235,400		249,100		
	Power input kW	18.91		21.16		22.25		
	Current input A	31.9-30.3-29.2		35.7-33.9-32.7		37.5-35.6-34.3		
	EER	3.33		3.26		3.28		
Temp. range of cooling	Indoor W.B.	15.0~24.0°C (59~75°F)		15.0~24.0°C (59~75°F)		15.0~24.0°C (59~75°F)		
	Outdoor D.B.	-5.0~52.0°C (23~126°F)		-5.0~52.0°C (23~126°F)		-5.0~52.0°C (23~126°F)		
Heating capacity (Nominal)	*2 kW	69.0		76.5		81.5		
	*2 BTU / h	235,400		261,000		278,100		
	Power input kW	19.22		22.43		23.90		
	Current input A	32.4-30.8-29.7		37.8-35.9-34.6		40.3-38.3-36.9		
	COP	3.59		3.41		3.41		
Temp. range of heating	Indoor D.B.	15.0~27.0°C (59~81°F)		15.0~27.0°C (59~81°F)		15.0~27.0°C (59~81°F)		
	Outdoor W.B.	-20.0~15.5°C (-4~60°F)		-20.0~15.5°C (-4~60°F)		-20.0~15.5°C (-4~60°F)		
Indoor unit connectable	Total capacity	50~130% of outdoor unit capacity		50~130% of outdoor unit capacity		50~130% of outdoor unit capacity		
	Model / Quantity	P15~P250/2~47		P15~P250/2~50		P15~P250/2~50		
Sound pressure level (measured in anechoic room)	dB <A>	63.5		63.5		64		
Sound power level (measured in anechoic room)	dB <A>	84.5		84.5		86		
Refrigerant piping diameter	Liquid pipe mm (in.)	15.88 (5/8) Brazed		15.88 (5/8) Brazed		15.88 (5/8) Brazed		
	Gas pipe mm (in.)	28.58 (1-1/8) Brazed		28.58 (1-1/8) Brazed		28.58 (1-1/8) Brazed		
<b>Set Model</b>								
Model		PUHY-P250YKB-A (-BS)		PUHY-P300YKB-A (-BS)		PUHY-P350YKB-A (-BS)		
FAN	Type x Quantity	Propeller fan x 1		Propeller fan x 1		Propeller fan x 1		
	Air flow rate	m <sup>3</sup> /min	175		210		210	
		L/s	2,917		3,500		3,500	
		cfm	6,179		7,415		7,415	
	Driving mechanism	Inverter-control, Direct-driven by motor		Inverter-control, Direct-driven by motor		Inverter-control, Direct-driven by motor		
Compressor	*3 Motor output kW	0.92 x 1		0.92 x 1		0.92 x 1		
	External static press.	0 Pa (0 mmH <sub>2</sub> O)		0 Pa (0 mmH <sub>2</sub> O)		0 Pa (0 mmH <sub>2</sub> O)		
	Type x Quantity	Inverter scroll hermetic compressor		Inverter scroll hermetic compressor		Inverter scroll hermetic compressor		
	Starting method	Inverter		Inverter		Inverter		
	Motor output kW	6.9		8.1		10.5		
	Case heater kW	-		-		-		
External finish		Pre-coated galvanized steel sheets (+powder coating for -BS type) <MUNSELL 5Y 8/1 or similar>		Pre-coated galvanized steel sheets (+powder coating for -BS type) <MUNSELL 5Y 8/1 or similar>		Pre-coated galvanized steel sheets (+powder coating for -BS type) <MUNSELL 5Y 8/1 or similar>		
External dimension HxWxD	mm	1,710 (1,650 without legs) x 920 x 740		1,710 (1,650 without legs) x 920 x 740		1,710 (1,650 without legs) x 1,220 x 740		
	in.	67-3/8 (65 without legs) x 36-1/4 x 29-3/16		67-3/8 (65 without legs) x 36-1/4 x 29-3/16		67-3/8 (65 without legs) x 48-1/16 x 29-3/16		
Protection devices	High pressure protection	High pressure sensor, High pressure switch at 4.15 MPa (601 psi)		High pressure sensor, High pressure switch at 4.15 MPa (601 psi)		High pressure sensor, High pressure switch at 4.15 MPa (601 psi)		
	Inverter circuit (COMP./FAN)	Over-heat protection, Over-current protection		Over-heat protection, Over-current protection		Over-heat protection, Over-current protection		
	Compressor	Over-heat protection		Over-heat protection		Over-heat protection		
	Fan motor	Over-current protection		Over-current protection		Over-current protection		
Refrigerant	Type x original charge	R410A x 8.0 kg (18 lbs)		R410A x 8.0 kg (18 lbs)		R410A x 11.5 kg (26 lbs)		
Net weight	kg (lbs)	199 (439)		199 (439)		251 (554)		
Heat exchanger		Salt-resistant cross fin & copper tube		Salt-resistant cross fin & copper tube		Salt-resistant cross fin & copper tube		
Pipe between unit and distributor	Liquid pipe mm (in.)	9.52 (3/8) Brazed		12.7 (1/2) Brazed		12.7 (1/2) Brazed		
	Gas pipe mm (in.)	22.2 (7/8) Brazed		22.2 (7/8) Brazed		28.58 (1-1/8) Brazed		
Optional parts		Outdoor Twinning kit: CMY-Y100VBK3 Joint: CMY-Y102SS/LS-G2, CMY-Y202S/302S-G2 Header: CMY-Y104/108/1010-G		Outdoor Twinning kit: CMY-Y100VBK3 Joint: CMY-Y102SS/LS-G2, CMY-Y202S/302S-G2 Header: CMY-Y104/108/1010-G		Outdoor Twinning kit: CMY-Y100VBK3 Joint: CMY-Y102SS/LS-G2, CMY-Y202S/302S-G2 Header: CMY-Y104/108/1010-G		

### Notes:

\*1, \*2 Nominal conditions

	Indoor	Outdoor	Pipe length	Level difference
Cooling	27°C DB/19°C WB (81°F DB/66°F WB)	35°C DB/24°C WB (95°F DB/75°F WB)	7.5m (24-9/16ft.)	0m (0ft.)
Heating	20°C DB/68°F DB)	7°C DB/6°C WB(45°F DB/43°F WB)	7.5m (24-9/16ft.)	0m (0ft.)

\*3 External static pressure option is available (30Pa, 60Pa / 3.1mmH<sub>2</sub>O, 6.1mmH<sub>2</sub>O).

\*Nominal condition \*1, \*2 are subject to JIS B8615-1.

\*Due to continuing improvement, above specification may be subject to change without notice.



# OUTDOOR UNIT

## Y Series

### PUHY-P YSKB-A(-BS)



## ► Specifications

Model			PUHY-P700YSKB-A (-BS)		PUHY-P750YSKB-A (-BS)		PUHY-P800YSKB-A (-BS)	
Power source			3-phase 4-wire 380-400-415 V 50/60 Hz		3-phase 4-wire 380-400-415 V 50/60 Hz		3-phase 4-wire 380-400-415 V 50/60 Hz	
Cooling capacity (Nominal)	*1	kW	80.0		85.0		90.0	
	*1	BTU / h	273,000		290,000		307,100	
		Power input kW	24.84		27.68		29.50	
		Current input A	41.9-39.8-38.3		46.7-44.3-42.7		49.8-47.3-45.6	
	EER	3.22		3.07		3.05		
Temp. range of cooling	Indoor	W.B.	15.0~24.0°C (59~75°F)		15.0~24.0°C (59~75°F)		15.0~24.0°C (59~75°F)	
	Outdoor	D.B.	-5.0~52.0°C (23~126°F)		-5.0~52.0°C (23~126°F)		-5.0~52.0°C (23~126°F)	
Heating capacity (Nominal)	*2	kW	88.0		95.0		100.0	
	*2	BTU / h	300,300		324,100		341,200	
		Power input kW	27.24		29.68		31.54	
		Current input A	45.9-43.6-42.1		50.1-47.5-45.8		53.2-50.5-48.7	
	COP	3.23		3.20		3.17		
Temp. range of heating	Indoor	D.B.	15.0~27.0°C (59~81°F)		15.0~27.0°C (59~81°F)		15.0~27.0°C (59~81°F)	
	Outdoor	W.B.	-20.0~15.5°C (-4~60°F)		-20.0~15.5°C (-4~60°F)		-20.0~15.5°C (-4~60°F)	
Indoor unit connectable	Total capacity		50~130% of outdoor unit capacity		50~130% of outdoor unit capacity		50~130% of outdoor unit capacity	
	Model / Quantity		P15~P250/2~50		P15~P250/2~50		P15~P250/2~50	
Sound pressure level (measured in anechoic room)		dB <A>	64		65.5		67.5	
Sound power level (measured in anechoic room)		dB <A>	86		86		87.5	
Refrigerant piping diameter	Liquid pipe		19.05 (3/4) Brazed		19.05 (3/4) Brazed		19.05 (3/4) Brazed	
	Gas pipe		34.93 (1-3/8) Brazed		34.93 (1-3/8) Brazed		34.93 (1-3/8) Brazed	
<b>Set Model</b>								
Model			PUHY-P350YKB-A (-BS)		PUHY-P350YKB-A (-BS)		PUHY-P400YKB-A (-BS)	
FAN	Type x Quantity		Propeller fan x 1		Propeller fan x 1		Propeller fan x 2	
	Air flow rate	m <sup>3</sup> /min	210		210		360	
		L/s	3,500		3,500		6,000	
		cfm	7,415		7,415		12,712	
Driving mechanism		Inverter-control, Direct-driven by motor		Inverter-control, Direct-driven by motor		Inverter-control, Direct-driven by motor		
*3	Motor output	kW	0.92 x 1		0.92 x 1		0.92 x 2	
	External static press.		0 Pa (0 mmH <sub>2</sub> O)		0 Pa (0 mmH <sub>2</sub> O)		0 Pa (0 mmH <sub>2</sub> O)	
	Type x Quantity		Inverter scroll hermetic compressor		Inverter scroll hermetic compressor		Inverter scroll hermetic compressor	
Compressor	Starting method		Inverter		Inverter		Inverter	
	Motor output	kW	10.5		10.5		12.4	
	Case heater	kW	-		-		0.045	
External finish			Pre-coated galvanized steel sheets (+powder coating for -BS type) <MUNSELL 5Y 8/1 or similar>		Pre-coated galvanized steel sheets (+powder coating for -BS type) <MUNSELL 5Y 8/1 or similar>		Pre-coated galvanized steel sheets (+powder coating for -BS type) <MUNSELL 5Y 8/1 or similar>	
External dimension HxWxD	mm		1,710 (1,650 without legs) x 1,220 x 740		1,710 (1,650 without legs) x 1,220 x 740		1,710 (1,650 without legs) x 1,750 x 740	
	in.		67-3/8 (65 without legs) x 48-1/16 x 29-3/16		67-3/8 (65 without legs) x 48-1/16 x 29-3/16		67-3/8 (65 without legs) x 68-15/16 x 29-3/16	
Protection devices	High pressure protection		High pressure sensor, High pressure switch at 4.15 MPa (601 psi)		High pressure sensor, High pressure switch at 4.15 MPa (601 psi)		High pressure sensor, High pressure switch at 4.15 MPa (601 psi)	
	Inverter circuit (COMP./FAN)		Over-heat protection, Over-current protection		Over-heat protection, Over-current protection		Over-heat protection, Over-current protection	
	Compressor		Over-heat protection, Over-current protection		Over-heat protection, Over-current protection		Over-heat protection, Over-current protection	
	Fan motor		Over-current protection		Over-current protection		Over-current protection	
Refrigerant	Type x original charge		R410A x 11.5 kg (26 lbs)		R410A x 11.5 kg (26 lbs)		R410A x 11.8 kg (27 lbs)	
Net weight	kg (lbs)		251 (554)		251 (554)		304 (671)	
Heat exchanger			Salt-resistant cross fin & copper tube		Salt-resistant cross fin & copper tube		Salt-resistant cross fin & copper tube	
Pipe between unit and distributor	Liquid pipe		12.7 (1/2) Brazed		12.7 (1/2) Brazed		15.88 (5/8) Brazed	
	Gas pipe		28.58 (1-1/8) Brazed		28.58 (1-1/8) Brazed		28.58 (1-1/8) Brazed	
Optional parts			Outdoor Twinning kit: CMY-Y200VBK2 Joint: CMY-Y102SS/LS-G2, CMY-Y202S/302S-G2 Header: CMY-Y104/108/1010-G		Outdoor Twinning kit: CMY-Y200VBK2 Joint: CMY-Y102SS/LS-G2, CMY-Y202S/302S-G2 Header: CMY-Y104/108/1010-G		Outdoor Twinning kit: CMY-Y200VBK2 Joint: CMY-Y102SS/LS-G2, CMY-Y202S/302S-G2 Header: CMY-Y104/108/1010-G	

### Notes:

\*1, \*2 Nominal conditions

	Indoor	Outdoor	Pipe length	Level difference
Cooling	27°C DB/19°C WB (81°F DB/66°F WB)	35°C DB/24°C WB (95°F DB/75°F WB)	7.5m (24-9/16ft.)	0m (0ft.)
Heating	20°C DB/68°F DB)	7°C DB/6°C WB(45°F DB/43°F WB)	7.5m (24-9/16ft.)	0m (0ft.)

\*3 External static pressure option is available (30Pa, 60Pa / 3.1mmH<sub>2</sub>O, 6.1mmH<sub>2</sub>O).

\*Nominal condition \*1, \*2 are subject to JIS B8615-1.

\*Due to continuing improvement, above specification may be subject to change without notice.

# OUTDOOR UNIT

## Y Series

### PUHY-P YSKB-A(-BS)



## ► Specifications

Model		PUHY-P850YSKB-A (-BS)		PUHY-P900YSKB-A (-BS)						
Power source		3-phase 4-wire 380-400-415 V 50/60 Hz		3-phase 4-wire 380-400-415 V 50/60 Hz						
Cooling capacity (Nominal)	*1 kW	96.0		101.0						
	*1 BTU / h	327,600		344,600						
	Power input kW	33.10		35.06						
	Current input A	55.8-53.0-51.1		59.1-56.2-54.1						
EER	kW / kW	2.90		2.88						
Temp. range of cooling	Indoor W.B.	15.0~24.0°C (59~75°F)		15.0~24.0°C (59~75°F)						
	Outdoor D.B.	-5.0~52.0°C (23~126°F)		-5.0~52.0°C (23~126°F)						
Heating capacity (Nominal)	*2 kW	108.0		113.0						
	*2 BTU / h	368,500		385,600						
	Power input kW	34.28		36.21						
	Current input A	57.8-54.9-52.9		61.1-58.0-55.9						
COP	kW / kW	3.15		3.12						
Temp. range of heating	Indoor D.B.	15.0~27.0°C (59~81°F)		15.0~27.0°C (59~81°F)						
	Outdoor W.B.	-20.0~15.5°C (-4~60°F)		-20.0~15.5°C (-4~60°F)						
Indoor unit connectable	Total capacity	50~130% of outdoor unit capacity		50~130% of outdoor unit capacity						
	Model / Quantity	P15~P250/2~50		P15~P250/2~50						
Sound pressure level (measured in anechoic room)	dB <A>	68		69						
Sound power level (measured in anechoic room)	dB <A>	87.5		88						
Refrigerant piping diameter	Liquid pipe mm (in.)	19.05 (3/4) Brazed		19.05 (3/4) Brazed						
	Gas pipe mm (in.)	41.28 (1-5/8) Brazed		41.28 (1-5/8) Brazed						
<b>Set Model</b>										
Model		PUHY-P400YKB-A (-BS)		PUHY-P450YKB-A (-BS)		PUHY-P450YKB-A (-BS)		PUHY-P450YKB-A (-BS)		
FAN	Type x Quantity	Propeller fan x 1		Propeller fan x 2		Propeller fan x 2		Propeller fan x 2		
	Air flow rate	m <sup>3</sup> /min	210		360		360		360	
		L/s	3,500		6,000		6,000		6,000	
		cfm	7,415		12,712		12,712		12,712	
	Driving mechanism	Inverter-control, Direct-driven by motor		Inverter-control, Direct-driven by motor		Inverter-control, Direct-driven by motor		Inverter-control, Direct-driven by motor		
	Motor output	0.92 x 1 kW		0.92 x 2 kW		0.92 x 2 kW		0.92 x 2 kW		
*3 External static press.	0 Pa (0 mmH <sub>2</sub> O)		0 Pa (0 mmH <sub>2</sub> O)		0 Pa (0 mmH <sub>2</sub> O)		0 Pa (0 mmH <sub>2</sub> O)			
Compressor	Type x Quantity	Inverter scroll hermetic compressor		Inverter scroll hermetic compressor		Inverter scroll hermetic compressor		Inverter scroll hermetic compressor		
	Starting method	Inverter		Inverter		Inverter		Inverter		
	Motor output	10.8 kW		12.4 kW		12.4 kW		12.4 kW		
	Case heater	-		0.045 kW		0.045 kW		0.045 kW		
External finish		Pre-coated galvanized steel sheets (+powder coating for -BS type) <MUNSELL 5Y 8/1 or similar>				Pre-coated galvanized steel sheets (+powder coating for -BS type) <MUNSELL 5Y 8/1 or similar>				
External dimension HxWxD	mm	1,710 (1,650 without legs) x 1,220 x 740		1,710 (1,650 without legs) x 1,750 x 740		1,710 (1,650 without legs) x 1,750 x 740		1,710 (1,650 without legs) x 1,750 x 740		
		67-3/8 (65 without legs) x 48-1/16 x 29-3/16		67-3/8 (65 without legs) x 68-15/16 x 29-3/16		67-3/8 (65 without legs) x 68-15/16 x 29-3/16		67-3/8 (65 without legs) x 68-15/16 x 29-3/16		
Protection devices	High pressure protection	High pressure sensor, High pressure switch at 4.15 MPa (601 psi)		High pressure sensor, High pressure switch at 4.15 MPa (601 psi)		High pressure sensor, High pressure switch at 4.15 MPa (601 psi)		High pressure sensor, High pressure switch at 4.15 MPa (601 psi)		
	Inverter circuit (COMP./FAN)	Over-heat protection, Over-current protection		Over-heat protection, Over-current protection		Over-heat protection, Over-current protection		Over-heat protection, Over-current protection		
	Compressor	Over-heat protection		Over-heat protection		Over-heat protection		Over-heat protection		
	Fan motor	Over-current protection		Over-current protection		Over-current protection		Over-current protection		
Refrigerant	Type x original charge	R410A x 11.5 kg (26 lbs)		R410A x 11.8 kg (27 lbs)		R410A x 11.8 kg (27 lbs)		R410A x 11.8 kg (27 lbs)		
Net weight	kg (lbs)	251 (554)		304 (671)		304 (671)		304 (671)		
Heat exchanger		Salt-resistant cross fin & copper tube				Salt-resistant cross fin & copper tube				
Pipe between unit and distributor	Liquid pipe mm (in.)	15.88 (5/8) Brazed		15.88 (5/8) Brazed		15.88 (5/8) Brazed		15.88 (5/8) Brazed		
	Gas pipe mm (in.)	28.58 (1-1/8) Brazed		28.58 (1-1/8) Brazed		28.58 (1-1/8) Brazed		28.58 (1-1/8) Brazed		
Optional parts		Outdoor Twinning kit: CMY-Y200VBK2 Joint: CMY-Y102SS/LS-G2, CMY-Y202S/302S-G2 Header: CMY-Y104/108/1010-G				Outdoor Twinning kit: CMY-Y200VBK2 Joint: CMY-Y102SS/LS-G2, CMY-Y202S/302S-G2 Header: CMY-Y104/108/1010-G				

### Notes:

\*1,\*2 Nominal conditions

	Indoor	Outdoor	Pipe length	Level difference
Cooling	27°C DB/19°C WB (81°F DB/66°F WB)	35°C DB/24°C WB (95°F DB/75°F WB)	7.5m (24-9/16ft.)	0m (0ft.)
Heating	20°C DB/68°F DB)	7°C DB/6°C WB(45°F DB/43°F WB)	7.5m (24-9/16ft.)	0m (0ft.)

\*3 External static pressure option is available (30Pa, 60Pa / 3.1mmH<sub>2</sub>O, 6.1mmH<sub>2</sub>O).

\*Nominal condition \*1,\*2 are subject to JIS B8615-1.

\*Due to continuing improvement, above specification may be subject to change without notice.



# OUTDOOR UNIT

## Y Series

### PUHY-P YSKB-A(-BS)



## ► Specifications

Model			PUHY-P950YSKB-A (-BS)				PUHY-P1000YSKB-A (-BS)			
Power source			3-phase 4-wire 380-400-415 V 50/60 Hz				3-phase 4-wire 380-400-415 V 50/60 Hz			
Cooling capacity (Nominal)	*1	kW	108.0				113.0			
	*1	BTU / h	368,500				385,600			
		Power input kW	33.85				35.20			
		Current input A	57.1-54.2-52.3				59.4-56.4-54.4			
		EER kW / kW	3.19				3.21			
Temp. range of cooling	Indoor	W.B.	15.0~24.0°C (59~75°F)				15.0~24.0°C (59~75°F)			
	Outdoor	D.B.	-5.0~52.0°C (23~126°F)				-5.0~52.0°C (23~126°F)			
Heating capacity (Nominal)	*2	kW	119.5				127.0			
	*2	BTU / h	407,700				433,300			
		Power input kW	34.63				36.70			
		Current input A	58.4-55.5-53.5				61.9-58.8-56.7			
		COP kW / kW	3.45				3.46			
Temp. range of heating	Indoor	D.B.	15.0~27.0°C (59~81°F)				15.0~27.0°C (59~81°F)			
	Outdoor	W.B.	-20.0~15.5°C (-4~60°F)				-20.0~15.5°C (-4~60°F)			
Indoor unit connectable	Total capacity		50~130% of outdoor unit capacity				50~130% of outdoor unit capacity			
	Model / Quantity		P15~P250/2~50				P15~P250/2~50			
Sound pressure level (measured in anechoic room)		dB <A>	66.5				66.5			
Sound power level (measured in anechoic room)		dB <A>	87				88			
Refrigerant piping diameter	Liquid pipe	mm (in.)	19.05 (3/4) Brazed				19.05 (3/4) Brazed			
	Gas pipe	mm (in.)	41.28 (1-5/8) Brazed				41.28 (1-5/8) Brazed			
<b>Set Model</b>										
Model			PUHY-P250YKB-A (-BS)	PUHY-P300YKB-A (-BS)	PUHY-P400YKB-A (-BS)	PUHY-P300YKB-A (-BS)	PUHY-P300YKB-A (-BS)	PUHY-P400YKB-A (-BS)		
FAN	Type x Quantity		Propeller fan x 1		Propeller fan x 1		Propeller fan x 1		Propeller fan x 1	
	Air flow rate	m <sup>3</sup> /min	175		210		210		210	
		L/s	2,917		3,500		3,500		3,500	
		cfm	6,179		7,415		7,415		7,415	
	Driving mechanism		Inverter-control, Direct-driven by motor				Inverter-control, Direct-driven by motor			
	Motor output	kW	0.92 x 1		0.92 x 1		0.92 x 1		0.92 x 1	
*3	External static press.	0 Pa (0 mmH <sub>2</sub> O)		0 Pa (0 mmH <sub>2</sub> O)		0 Pa (0 mmH <sub>2</sub> O)		0 Pa (0 mmH <sub>2</sub> O)		
Compressor	Type x Quantity		Inverter scroll hermetic compressor				Inverter scroll hermetic compressor			
	Starting method		Inverter		Inverter		Inverter		Inverter	
	Motor output	kW	6.9		8.1		10.8		8.1	
	Case heater	kW	-		-		-		-	
External finish			Pre-coated galvanized steel sheets (+powder coating for -BS type) <MUNSELL 5Y 8/1 or similar>				Pre-coated galvanized steel sheets (+powder coating for -BS type) <MUNSELL 5Y 8/1 or similar>			
External dimension HxWxD	mm		1,710 (1,650 without legs) x 920 x 740		1,710 (1,650 without legs) x 1,220 x 740		1,710 (1,650 without legs) x 1,220 x 740		1,710 (1,650 without legs) x 1,220 x 740	
	in.		67-3/8 (65 without legs) x 36-1/4 x 29-3/16		67-3/8 (65 without legs) x 48-1/16 x 29-3/16		67-3/8 (65 without legs) x 48-1/16 x 29-3/16		67-3/8 (65 without legs) x 48-1/16 x 29-3/16	
Protection devices	High pressure protection		High pressure sensor, High pressure switch at 4.15 MPa (601 psi)				High pressure sensor, High pressure switch at 4.15 MPa (601 psi)			
	Inverter circuit (COMP/FAN)		Over-heat protection, Over-current protection				Over-heat protection, Over-current protection			
	Compressor		Over-heat protection		Over-heat protection		Over-heat protection		Over-heat protection	
	Fan motor		Over-current protection		Over-current protection		Over-current protection		Over-current protection	
Refrigerant	Type x original charge	R410A x 8.0 kg (18 lbs)		R410A x 11.5 kg (26 lbs)		R410A x 11.5 kg (26 lbs)		R410A x 11.5 kg (26 lbs)		
Net weight	kg (lbs)	199 (439)		251 (554)		251 (554)		251 (554)		
Heat exchanger			Salt-resistant cross fin & copper tube				Salt-resistant cross fin & copper tube			
Pipe between unit and distributor	Liquid pipe	mm (in.)	9.52 (3/8) Brazed		12.7 (1/2) Brazed		15.88 (5/8) Brazed		12.7 (1/2) Brazed	
	Gas pipe	mm (in.)	22.2 (7/8) Brazed		22.2 (7/8) Brazed		28.58 (1-1/8) Brazed		22.2 (7/8) Brazed	
Optional parts			Outdoor Twinning kit: CMY-Y300VBK3 Joint: CMY-Y102SS/LS-G2, CMY-Y202/302S-G2 Header: CMY-Y104/108/1010-G				Outdoor Twinning kit: CMY-Y300VBK3 Joint: CMY-Y102SS/LS-G2, CMY-Y202/302S-G2 Header: CMY-Y104/108/1010-G			

### Notes:

\*1,\*2 Nominal conditions

	Indoor	Outdoor	Pipe length	Level difference
Cooling	27°C DB/19°C WB (81°F DB/66°F WB)	35°C DB/24°C WB (95°F DB/75°F WB)	7.5m (24-9/16ft.)	0m (0ft.)
Heating	20°C DB/68°F DB)	7°C DB/6°C WB(45°F DB/43°F WB)	7.5m (24-9/16ft.)	0m (0ft.)

\*3 External static pressure option is available (30Pa, 60Pa / 3.1mmH<sub>2</sub>O, 6.1mmH<sub>2</sub>O).

\*Nominal condition \*1,\*2 are subject to JIS B8615-1.

\*Due to continuing improvement, above specification may be subject to change without notice.



Outdoor Unit



# OUTDOOR UNIT

## Y Series

### PUHY-P YSKB-A(-BS)



## ► Specifications

Model		PUHY-P1050YSKB-A (-BS)		PUHY-P1100YSKB-A (-BS)				
Power source		3-phase 4-wire 380-400-415 V 50/60 Hz		3-phase 4-wire 380-400-415 V 50/60 Hz				
Cooling capacity (Nominal)	*1 kW	118.0		124.0				
	*1 BTU / h	402,600		423,100				
	Power input kW	37.34		39.74				
	Current input A	63.0-59.8-57.7		67.0-63.7-61.4				
EER	kW / kW	3.16		3.12				
Temp. range of cooling	Indoor W.B.	15.0~24.0°C (59~75°F)		15.0~24.0°C (59~75°F)				
	Outdoor D.B.	-5.0~52.0°C (23~126°F)		-5.0~52.0°C (23~126°F)				
Heating capacity (Nominal)	*2 kW	132.0		140.0				
	*2 BTU / h	450,400		477,700				
	Power input kW	39.63		43.61				
	Current input A	66.9-63.5-61.2		73.6-69.9-67.4				
COP	kW / kW	3.33		3.21				
Temp. range of heating	Indoor D.B.	15.0~27.0°C (59~81°F)		15.0~27.0°C (59~81°F)				
	Outdoor W.B.	-20.0~15.5°C (-4~60°F)		-20.0~15.5°C (-4~60°F)				
Indoor unit connectable	Total capacity	50~130% of outdoor unit capacity		50~130% of outdoor unit capacity				
	Model / Quantity	P15~P250/2~50		P15~P250/2~50				
Sound pressure level (measured in anechoic room)	dB <A>	66.5		66.5				
Sound power level (measured in anechoic room)	dB <A>	88		88				
Refrigerant piping diameter	Liquid pipe mm (in.)	19.05 (3/4) Brazed		19.05 (3/4) Brazed				
	Gas pipe mm (in.)	41.28 (1-5/8) Brazed		41.28 (1-5/8) Brazed				
<b>Set Model</b>								
Model		PUHY-P300YKB-A (-BS)	PUHY-P350YKB-A (-BS)	PUHY-P400YKB-A (-BS)	PUHY-P350YKB-A (-BS)	PUHY-P350YKB-A (-BS)	PUHY-P400YKB-A (-BS)	
FAN	Type x Quantity	Propeller fan x 1		Propeller fan x 1		Propeller fan x 1		
	Air flow rate	m <sup>3</sup> /min	210		210		210	
		L/s	3,500		3,500		3,500	
		cfm	7,415		7,415		7,415	
	Driving mechanism	Inverter-control, Direct-driven by motor				Inverter-control, Direct-driven by motor		
Motor output	kW	0.92 x 1		0.92 x 1		0.92 x 1		
*3 External static press.		0 Pa (0 mmH <sub>2</sub> O)		0 Pa (0 mmH <sub>2</sub> O)		0 Pa (0 mmH <sub>2</sub> O)		
Compressor	Type x Quantity	Inverter scroll hermetic compressor				Inverter scroll hermetic compressor		
	Starting method	Inverter		Inverter		Inverter		
	Motor output	kW	8.1		10.5		10.8	
	Case heater	kW	-		-		-	
External finish		Pre-coated galvanized steel sheets (+powder coating for -BS type) <MUNSELL 5Y 8/1 or similar>				Pre-coated galvanized steel sheets (+powder coating for -BS type) <MUNSELL 5Y 8/1 or similar>		
External dimension HxWxD	mm	1,710 (1,650 without legs) x 1,220 x 740		1,710 (1,650 without legs) x 1,220 x 740		1,710 (1,650 without legs) x 1,220 x 740		
	in.	67-3/8 (65 without legs) x 48-1/16 x 29-3/16		67-3/8 (65 without legs) x 48-1/16 x 29-3/16		67-3/8 (65 without legs) x 48-1/16 x 29-3/16		
Protection devices	High pressure protection	High pressure sensor, High pressure switch at 4.15 MPa (601 psi)				High pressure sensor, High pressure switch at 4.15 MPa (601 psi)		
	Inverter circuit (COMP/FAN)	Over-heat protection, Over-current protection				Over-heat protection, Over-current protection		
	Compressor	Over-heat protection		Over-heat protection		Over-heat protection		
	Fan motor	Over-current protection		Over-current protection		Over-current protection		
Refrigerant	Type x original charge	R410A x 11.5 kg (26 lbs)		R410A x 11.5 kg (26 lbs)		R410A x 11.5 kg (26 lbs)		
Net weight	kg (lbs)	251 (554)		251 (554)		251 (554)		
Heat exchanger		Salt-resistant cross fin & copper tube				Salt-resistant cross fin & copper tube		
Pipe between unit and distributor	Liquid pipe mm (in.)	12.7 (1/2) Brazed		12.7 (1/2) Brazed		12.7 (1/2) Brazed		
	Gas pipe mm (in.)	22.2 (7/8) Brazed		28.58 (1-1/8) Brazed		28.58 (1-1/8) Brazed		
Optional parts		Outdoor Twinning kit: CMY-Y300VBK3 Joint: CMY-Y102SS/LS-G2, CMY-Y202/302S-G2 Header: CMY-Y104/108/1010-G				Outdoor Twinning kit: CMY-Y300VBK3 Joint: CMY-Y102SS/LS-G2, CMY-Y202/302S-G2 Header: CMY-Y104/108/1010-G		

### Notes:

\*1, \*2 Nominal conditions

	Indoor	Outdoor	Pipe length	Level difference
Cooling	27°C DB/19°C WB (81°F DB/66°F WB)	35°C DB/24°C WB (95°F DB/75°F WB)	7.5m (24-9/16ft.)	0m (0ft.)
Heating	20°C DB/68°F DB)	7°C DB/6°C WB(45°F DB/43°F WB)	7.5m (24-9/16ft.)	0m (0ft.)

\*3 External static pressure option is available (30Pa, 60Pa / 3.1mmH<sub>2</sub>O, 6.1mmH<sub>2</sub>O).

\*Nominal condition \*1, \*2 are subject to JIS B8615-1.

\*Due to continuing improvement, above specification may be subject to change without notice.



# OUTDOOR UNIT

## Y Series

### PUHY-P YSKB-A(-BS)



## ► Specifications

Model		PUHY-P1150YSKB-A (-BS)			PUHY-P1200YSKB-A (-BS)			
Power source		3-phase 4-wire 380-400-415 V 50/60 Hz			3-phase 4-wire 380-400-415 V 50/60 Hz			
Cooling capacity (Nominal)	*1 kW	130.0			136.0			
	*1 BTU / h	443,600			464,000			
	Power input kW	41.93			45.18			
	Current input A	70.7-67.2-64.8			76.2-72.4-69.8			
	EER kW / kW	3.10			3.01			
Temp. range of cooling	Indoor W.B.	15.0-24.0°C (59-75°F)			15.0-24.0°C (59-75°F)			
	Outdoor D.B.	-5.0-52.0°C (23-126°F)			-5.0-52.0°C (23-126°F)			
Heating capacity (Nominal)	*2 kW	145.0			150.0			
	*2 BTU / h	494,700			511,800			
	Power input kW	45.45			47.31			
	Current input A	76.7-72.8-70.2			79.8-75.8-73.1			
	COP kW / kW	3.19			3.17			
Temp. range of heating	Indoor D.B.	15.0-27.0°C (59-81°F)			15.0-27.0°C (59-81°F)			
	Outdoor W.B.	-20.0-15.5°C (-4-60°F)			-20.0-15.5°C (-4-60°F)			
Indoor unit connectable	Total capacity	50-130% of outdoor unit capacity			50-130% of outdoor unit capacity			
	Model / Quantity	P15-P250/2-50			P15-P250/2-50			
Sound pressure level (measured in anechoic room)	dB <A>	68.5			69			
Sound power level (measured in anechoic room)	dB <A>	88.5			88.5			
Refrigerant piping diameter	Liquid pipe mm (in.)	19.05 (3/4) Brazed			19.05 (3/4) Brazed			
	Gas pipe mm (in.)	41.28 (1-5/8) Brazed			41.28 (1-5/8) Brazed			
<b>Set Model</b>								
Model		PUHY-P350YKB-A (-BS)	PUHY-P350YKB-A (-BS)	PUHY-P450YKB-A (-BS)	PUHY-P350YKB-A (-BS)	PUHY-P400YKB-A (-BS)	PUHY-P450YKB-A (-BS)	
FAN	Type x Quantity	Propeller fan x 1		Propeller fan x 2	Propeller fan x 1		Propeller fan x 2	
	Air flow rate	m <sup>3</sup> /min	210	210	360	210	210	360
		L/s	3,500	3,500	6,000	3,500	3,500	6,000
		cfm	7,415	7,415	12,712	7,415	7,415	12,712
	Driving mechanism	Inverter-control, Direct-driven by motor				Inverter-control, Direct-driven by motor		
	Motor output kW	0.92 x 1	0.92 x 1	0.92 x 2	0.92 x 1	0.92 x 1	0.92 x 2	
*3 External static press.	0 Pa (0 mmH <sub>2</sub> O)	0 Pa (0 mmH <sub>2</sub> O)	0 Pa (0 mmH <sub>2</sub> O)	0 Pa (0 mmH <sub>2</sub> O)	0 Pa (0 mmH <sub>2</sub> O)	0 Pa (0 mmH <sub>2</sub> O)		
Compressor	Type x Quantity	Inverter scroll hermetic compressor			Inverter scroll hermetic compressor			
	Starting method	Inverter	Inverter	Inverter	Inverter	Inverter	Inverter	
	Motor output kW	10.5	10.5	12.4	10.5	10.8	12.4	
	Case heater kW	-	-	0.045	-	-	0.045	
External finish		Pre-coated galvanized steel sheets (+powder coating for -BS type) <MUNSELL 5Y 8/1 or similar>			Pre-coated galvanized steel sheets (+powder coating for -BS type) <MUNSELL 5Y 8/1 or similar>			
External dimension HxWxD	mm	1,710 (1,650 without legs) x 1,220 x 740	1,710 (1,650 without legs) x 1,220 x 740	1,710 (1,650 without legs) x 1,750 x 740	1,710 (1,650 without legs) x 1,220 x 740	1,710 (1,650 without legs) x 1,220 x 740	1,710 (1,650 without legs) x 1,750 x 740	
	in.	67-3/8 (65 without legs) x 48-1/16 x 29-3/16	67-3/8 (65 without legs) x 48-1/16 x 29-3/16	67-3/8 (65 without legs) x 68-15/16 x 29-3/16	67-3/8 (65 without legs) x 48-1/16 x 29-3/16	67-3/8 (65 without legs) x 48-1/16 x 29-3/16	67-3/8 (65 without legs) x 68-15/16 x 29-3/16	
Protection devices	High pressure protection	High pressure sensor, High pressure switch at 4.15 MPa (601 psi)			High pressure sensor, High pressure switch at 4.15 MPa (601 psi)			
	Inverter circuit (COMP/FAN)	Over-heat protection, Over-current protection			Over-heat protection, Over-current protection			
	Compressor	Over-heat protection	Over-heat protection	Over-heat protection	Over-heat protection	Over-heat protection	Over-heat protection	
Refrigerant	Fan motor	Over-current protection	Over-current protection	Over-current protection	Over-current protection	Over-current protection	Over-current protection	
	Type x original charge	R410A x 11.5 kg (26 lbs)	R410A x 11.5 kg (26 lbs)	R410A x 11.8 kg (27 lbs)	R410A x 11.5 kg (26 lbs)	R410A x 11.5 kg (26 lbs)	R410A x 11.8 kg (27 lbs)	
Net weight	kg (lbs)	251 (554)	251 (554)	304 (671)	251 (554)	251 (554)	304 (671)	
Heat exchanger		Salt-resistant cross fin & copper tube			Salt-resistant cross fin & copper tube			
Pipe between unit and distributor	Liquid pipe mm (in.)	12.7 (1/2) Brazed	12.7 (1/2) Brazed	15.88 (5/8) Brazed	12.7 (1/2) Brazed	15.88 (5/8) Brazed	15.88 (5/8) Brazed	
	Gas pipe mm (in.)	28.58 (1-1/8) Brazed	28.58 (1-1/8) Brazed	28.58 (1-1/8) Brazed	28.58 (1-1/8) Brazed	28.58 (1-1/8) Brazed	28.58 (1-1/8) Brazed	
Optional parts		Outdoor Twinning kit: CMY-Y300VBK3 Joint: CMY-Y102SS/LS-G2, CMY-Y202/302S-G2 Header: CMY-Y104/108/1010-G			Outdoor Twinning kit: CMY-Y300VBK3 Joint: CMY-Y102SS/LS-G2, CMY-Y202/302S-G2 Header: CMY-Y104/108/1010-G			

### Notes:

\*1,\*2 Nominal conditions

	Indoor	Outdoor	Pipe length	Level difference
Cooling	27°C DB/19°C WB (81°F DB/66°F WB)	35°C DB/24°C WB (95°F DB/75°F WB)	7.5m (24-9/16ft.)	0m (0ft.)
Heating	20°C DB(68°F DB)	7°C DB/6°C WB(45°F DB/43°F WB)	7.5m (24-9/16ft.)	0m (0ft.)

\*3 External static pressure option is available (30Pa, 60Pa / 3.1mmH<sub>2</sub>O, 6.1mmH<sub>2</sub>O).

\*Nominal condition \*1,\*2 are subject to JIS B8615-1.

\*Due to continuing improvement, above specification may be subject to change without notice.



# OUTDOOR UNIT

## Y Series

### PUHY-P YSKB-A(-BS)



## ► Specifications

Model		PUHY-P1250YSKB-A (-BS)			PUHY-P1300YSKB-A (-BS)			
Power source		3-phase 4-wire 380-400-415 V 50/60 Hz			3-phase 4-wire 380-400-415 V 50/60 Hz			
Cooling capacity (Nominal)	*1 kW	140.0			146.0			
	*1 BTU / h	477,700			498,200			
	Power input kW	46.82			50.51			
	Current input A	79.0-75.0-72.3			85.2-81.0-78.0			
EER	kW / kW	2.99			2.89			
Temp. range of cooling	Indoor W.B.	15.0~24.0°C (59~75°F)			15.0~24.0°C (59~75°F)			
	Outdoor D.B.	-5.0~52.0°C (23~126°F)			-5.0~52.0°C (23~126°F)			
Heating capacity (Nominal)	*2 kW	156.5			163.0			
	*2 BTU / h	534,000			556,200			
	Power input kW	49.52			51.91			
	Current input A	83.5-79.4-76.5			87.6-83.2-80.2			
COP	kW / kW	3.16			3.14			
Temp. range of heating	Indoor D.B.	15.0~27.0°C (59~81°F)			15.0~27.0°C (59~81°F)			
	Outdoor W.B.	-20.0~15.5°C (-4~60°F)			-20.0~15.5°C (-4~60°F)			
Indoor unit connectable	Total capacity	50~130% of outdoor unit capacity			50~130% of outdoor unit capacity			
	Model / Quantity	P15~P250/2~50			P15~P250/2~50			
Sound pressure level (measured in anechoic room)	dB <A>	70			70			
Sound power level (measured in anechoic room)	dB <A>	89.5			89.5			
Refrigerant piping diameter	Liquid pipe mm (in.)	19.05 (3/4) Brazed			19.05 (3/4) Brazed			
	Gas pipe mm (in.)	41.28 (1-5/8) Brazed			41.28 (1-5/8) Brazed			
<b>Set Model</b>								
Model		PUHY-P350YKB-A (-BS)	PUHY-P450YKB-A (-BS)	PUHY-P450YKB-A (-BS)	PUHY-P400YKB-A (-BS)	PUHY-P450YKB-A (-BS)	PUHY-P450YKB-A (-BS)	
FAN	Type x Quantity	Propeller fan x 1		Propeller fan x 2	Propeller fan x 2	Propeller fan x 1	Propeller fan x 2	
	Air flow rate	m <sup>3</sup> /min	210		360	360	210	360
		L/s	3,500		6,000	6,000	3,500	6,000
		cfm	7,415		12,712	12,712	7,415	12,712
	Driving mechanism	Inverter-control, Direct-driven by motor				Inverter-control, Direct-driven by motor		
	Motor output	kW	0.92 x 1	0.92 x 2	0.92 x 2	0.92 x 1	0.92 x 2	0.92 x 2
*3 External static press.		0 Pa (0 mmH <sub>2</sub> O)	0 Pa (0 mmH <sub>2</sub> O)	0 Pa (0 mmH <sub>2</sub> O)	0 Pa (0 mmH <sub>2</sub> O)	0 Pa (0 mmH <sub>2</sub> O)	0 Pa (0 mmH <sub>2</sub> O)	
Compressor	Type x Quantity	Inverter scroll hermetic compressor			Inverter scroll hermetic compressor			
	Starting method	Inverter	Inverter	Inverter	Inverter	Inverter	Inverter	
	Motor output	kW	10.5	12.4	12.4	10.8	12.4	12.4
	Case heater	kW	—	0.045	0.045	—	0.045	0.045
External finish		Pre-coated galvanized steel sheets (+powder coating for -BS type) <MUNSELL 5Y 8/1 or similar>			Pre-coated galvanized steel sheets (+powder coating for -BS type) <MUNSELL 5Y 8/1 or similar>			
External dimension HxWxD	mm	1,710 (1,650 without legs) x 1,220 x 740	1,710 (1,650 without legs) x 1,750 x 740	1,710 (1,650 without legs) x 1,750 x 740	1,710 (1,650 without legs) x 1,220 x 740	1,710 (1,650 without legs) x 1,750 x 740	1,710 (1,650 without legs) x 1,750 x 740	
	in.	67-3/8 (65 without legs) x 48-1/16 x 29-3/16	67-3/8 (65 without legs) x 68-15/16 x 29-3/16	67-3/8 (65 without legs) x 68-15/16 x 29-3/16	67-3/8 (65 without legs) x 48-1/16 x 29-3/16	67-3/8 (65 without legs) x 68-15/16 x 29-3/16	67-3/8 (65 without legs) x 68-15/16 x 29-3/16	
Protection devices	High pressure protection	High pressure sensor, High pressure switch at 4.15 MPa (601 psi)			High pressure sensor, High pressure switch at 4.15 MPa (601 psi)			
	Inverter circuit (COMP/FAN)	Over-heat protection, Over-current protection			Over-heat protection, Over-current protection			
	Compressor	Over-heat protection	Over-heat protection	Over-heat protection	Over-heat protection	Over-heat protection	Over-heat protection	
Refrigerant	Fan motor	Over-current protection	Over-current protection	Over-current protection	Over-current protection	Over-current protection	Over-current protection	
	Type x original charge	R410A x 11.5 kg (26 lbs)	R410A x 11.8 kg (27 lbs)	R410A x 11.8 kg (27 lbs)	R410A x 11.5 kg (26 lbs)	R410A x 11.8 kg (27 lbs)	R410A x 11.8 kg (27 lbs)	
Net weight	kg (lbs)	251 (554)	304 (671)	304 (671)	251 (554)	304 (671)	304 (671)	
Heat exchanger		Salt-resistant cross fin & copper tube			Salt-resistant cross fin & copper tube			
Pipe between unit and distributor	Liquid pipe mm (in.)	12.7 (1/2) Brazed	15.88 (5/8) Brazed	15.88 (5/8) Brazed	15.88 (5/8) Brazed	15.88 (5/8) Brazed	15.88 (5/8) Brazed	
	Gas pipe mm (in.)	28.58 (1-1/8) Brazed	28.58 (1-1/8) Brazed	28.58 (1-1/8) Brazed	28.58 (1-1/8) Brazed	28.58 (1-1/8) Brazed	28.58 (1-1/8) Brazed	
Optional parts		Outdoor Twinning kit: CMY-Y300VBK3 Joint: CMY-Y102SS/LS-G2, CMY-Y202/302S-G2 Header: CMY-Y104/108/1010-G			Outdoor Twinning kit: CMY-Y300VBK3 Joint: CMY-Y102SS/LS-G2, CMY-Y202/302S-G2 Header: CMY-Y104/108/1010-G			

### Notes:

\*1, \*2 Nominal conditions

	Indoor	Outdoor	Pipe length	Level difference
Cooling	27°C DB/19°C WB (81°F DB/66°F WB)	35°C DB/24°C WB (95°F DB/75°F WB)	7.5m (24-9/16ft.)	0m (0ft.)
Heating	20°C DB(68°F DB)	7°C DB/6°C WB(45°F DB/43°F WB)	7.5m (24-9/16ft.)	0m (0ft.)

\*3 External static pressure option is available (30Pa, 60Pa / 3.1mmH<sub>2</sub>O, 6.1mmH<sub>2</sub>O).

\*Nominal condition \*1, \*2 are subject to JIS B8615-1.

\*Due to continuing improvement, above specification may be subject to change without notice.



# OUTDOOR UNIT

## Y Series

### PUHY-P YSKB-A(-BS)



## ► Specifications

Model		PUHY-P1350YSKB-A (-BS)			
Power source		3-phase 4-wire 380-400-415 V 50/60 Hz			
Cooling capacity (Nominal)	*1 kW	150.0			
	*1 BTU / h	511,800			
	Power input kW	52.08			
	Current input A	87.9-83.5-80.5			
EER	kW / kW	2.88			
Temp. range of cooling	Indoor W.B.	15.0~24.0°C (59~75°F)			
	Outdoor D.B.	-5.0~52.0°C (23~126°F)			
Heating capacity (Nominal)	*2 kW	168.0			
	*2 BTU / h	573,200			
	Power input kW	53.84			
	Current input A	90.8-86.3-83.2			
COP	kW / kW	3.12			
Temp. range of heating	Indoor D.B.	15.0~27.0°C (59~81°F)			
	Outdoor W.B.	-20.0~15.5°C (-4~60°F)			
Indoor unit connectable	Total capacity	50~130% of outdoor unit capacity			
	Model / Quantity	P15~P250/2~50			
Sound pressure level (measured in anechoic room)	dB <A>	71			
Sound power level (measured in anechoic room)	dB <A>	90			
Refrigerant piping diameter	Liquid pipe mm (in.)	19.05 (3/4) Brazed			
	Gas pipe mm (in.)	41.28 (1-5/8) Brazed			
<b>Set Model</b>					
Model		PUHY-P450YKB-A (-BS)	PUHY-P450YKB-A (-BS)	PUHY-P450YKB-A (-BS)	
FAN	Type x Quantity	Propeller fan x 2			
	Air flow rate	m <sup>3</sup> /min	360	360	360
		L/s	6,000	6,000	6,000
		cfm	12,712	12,712	12,712
	Driving mechanism	Inverter-control, Direct-driven by motor			
	Motor output	kW	0.92 x 2	0.92 x 2	0.92 x 2
*3 External static press.		0 Pa (0 mmH <sub>2</sub> O)	0 Pa (0 mmH <sub>2</sub> O)	0 Pa (0 mmH <sub>2</sub> O)	
Compressor	Type x Quantity	Inverter scroll hermetic compressor			
	Starting method	Inverter			
	Motor output	kW	12.4	12.4	12.4
	Case heater	kW	0.045	0.045	0.045
External finish		Pre-coated galvanized steel sheets (+powder coating for -BS type) <MUNSELL 5Y 8/1 or similar>	Pre-coated galvanized steel sheets (+powder coating for -BS type) <MUNSELL 5Y 8/1 or similar>	Pre-coated galvanized steel sheets (+powder coating for -BS type) <MUNSELL 5Y 8/1 or similar>	
External dimension HxWxD	mm	1,710 (1,650 without legs) x 1,750 x 740	1,710 (1,650 without legs) x 1,750 x 740	1,710 (1,650 without legs) x 1,750 x 740	
	in.	67-3/8 (65 without legs) x 68-15/16 x 29-3/16	67-3/8 (65 without legs) x 68-15/16 x 29-3/16	67-3/8 (65 without legs) x 68-15/16 x 29-3/16	
Protection devices	High pressure protection	High pressure sensor, High pressure switch at 4.15 MPa (601 psi)	High pressure sensor, High pressure switch at 4.15 MPa (601 psi)	High pressure sensor, High pressure switch at 4.15 MPa (601 psi)	
	Inverter circuit (COMP./FAN)	Over-heat protection, Over-current protection	Over-heat protection, Over-current protection	Over-heat protection, Over-current protection	
	Compressor	Over-heat protection	Over-heat protection	Over-heat protection	
	Fan motor	Over-current protection	Over-current protection	Over-current protection	
Refrigerant	Type x original charge	R410A x 11.8 kg (27 lbs)	R410A x 11.8 kg (27 lbs)	R410A x 11.8 kg (27 lbs)	
Net weight	kg (lbs)	304 (671)	304 (671)	304 (671)	
Heat exchanger		Salt-resistant cross fin & copper tube	Salt-resistant cross fin & copper tube	Salt-resistant cross fin & copper tube	
Pipe between unit and distributor	Liquid pipe mm (in.)	15.88 (5/8) Brazed	15.88 (5/8) Brazed	15.88 (5/8) Brazed	
	Gas pipe mm (in.)	28.58 (1-1/8) Brazed	28.58 (1-1/8) Brazed	28.58 (1-1/8) Brazed	
Optional parts		Outdoor Twinning kit: CMY-Y300VBK3 Joint: CMY-Y102SS/LS-G2, CMY-Y202/302S-G2 Header: CMY-Y104/108/1010-G			

### Notes:

\*1,\*2 Nominal conditions

	Indoor	Outdoor	Pipe length	Level difference
Cooling	27°C DB/19°C WB (81°F DB/66°F WB)	35°C DB/24°C WB (95°F DB/75°F WB)	7.5m (24-9/16ft.)	0m (0ft.)
Heating	20°C DB/68°F DB)	7°C DB/6°C WB(45°F DB/43°F WB)	7.5m (24-9/16ft.)	0m (0ft.)

\*3 External static pressure option is available (30Pa, 60Pa / 3.1mmH<sub>2</sub>O, 6.1mmH<sub>2</sub>O).

\*Nominal condition \*1,\*2 are subject to JIS B8615-1.

\*Due to continuing improvement, above specification may be subject to change without notice.



# OUTDOOR UNIT

## Y Series - High COP

### PUHY-EP YLM-A(-BS)



## ► Specifications

Model	PUHY-EP200YLM-A (-BS)		PUHY-EP250YLM-A (-BS)		PUHY-EP300YLM-A (-BS)		
Power source	3-phase 4-wire 380-400-415 V 50/60 Hz		3-phase 4-wire 380-400-415 V 50/60 Hz		3-phase 4-wire 380-400-415 V 50/60 Hz		
Cooling capacity (Nominal)	*1 kW	22.4	28.0	33.5			
	*1 BTU / h	76,400	95,500	114,300			
	Power input kW	5.19	6.89	8.56			
	Current input A	8.7-8.3-8.0	11.6-11.0-10.6	14.4-13.7-13.2			
	EER kW / kW	4.31	4.06	3.91			
Temp. range of cooling	Indoor W.B.	15.0~24.0°C (59~75°F)	15.0~24.0°C (59~75°F)	15.0~24.0°C (59~75°F)			
	Outdoor D.B.	-5.0~52.0°C (23~126°F)	-5.0~52.0°C (23~126°F)	-5.0~52.0°C (23~126°F)			
Heating capacity (Nominal)	*2 kW	25.0	31.5	37.5			
	*2 BTU / h	85,300	107,500	128,000			
	Power input kW	5.73	7.68	9.16			
	Current input A	9.6-9.1-8.8	12.9-12.3-11.8	15.4-14.6-14.1			
	COP kW / kW	4.36	4.10	4.09			
Temp. range of heating	Indoor D.B.	15.0~27.0°C (59~81°F)	15.0~27.0°C (59~81°F)	15.0~27.0°C (59~81°F)			
	Outdoor W.B.	-20.0~15.5°C (-4~60°F)	-20.0~15.5°C (-4~60°F)	-20.0~15.5°C (-4~60°F)			
Indoor unit connectable	Total capacity	50~130% of outdoor unit capacity	50~130% of outdoor unit capacity	50~130% of outdoor unit capacity			
	Model / Quantity	P15~P250/1~17	P15~P250/1~21	P15~P250/1~26			
Sound pressure level (measured in anechoic room)	dB <A>	57	60	61			
Sound power level (measured in anechoic room)	dB <A>	79.5	80	82			
Refrigerant piping diameter	Liquid pipe mm (in.)	9.52 (3/8) Brazed	9.52 (3/8) Brazed (12.7 (1/2) Brazed, farthest length >= 90 m)	9.52 (3/8) Brazed (12.7 (1/2) Brazed, farthest length >= 40 m)			
	Gas pipe mm (in.)	22.2 (7/8) Brazed	22.2 (7/8) Brazed	28.58 (1-1/8) Brazed			
FAN	Type x Quantity	Propeller fan x 1	Propeller fan x 1	Propeller fan x 1			
	Air flow rate	m <sup>3</sup> /min	175	175	200		
		L/s	2,917	2,917	3,333		
		cfm	6,179	6,179	7,062		
	Driving mechanism	Inverter-control, Direct-driven by motor	Inverter-control, Direct-driven by motor	Inverter-control, Direct-driven by motor			
	Motor output kW	0.92 x 1	0.92 x 1	0.92 x 1			
	*3 External static press.	0 Pa (0 mmH <sub>2</sub> O)	0 Pa (0 mmH <sub>2</sub> O)	0 Pa (0 mmH <sub>2</sub> O)			
Compressor	Type x Quantity	Inverter scroll hermetic compressor	Inverter scroll hermetic compressor	Inverter scroll hermetic compressor			
	Starting method	Inverter	Inverter	Inverter			
	Motor output kW	5.6	6.9	8.1			
	Case heater kW	-	-	-			
External finish	Pre-coated galvanized steel sheets (+powder coating for -BS type) <MUNSELL 5Y 8/1 or similar>		Pre-coated galvanized steel sheets (+powder coating for -BS type) <MUNSELL 5Y 8/1 or similar>	Pre-coated galvanized steel sheets (+powder coating for -BS type) <MUNSELL 5Y 8/1 or similar>			
External dimension HxWxD	mm	1,710 (1,650 without legs) x 920 x 740	1,710 (1,650 without legs) x 920 x 740	1,710 (1,650 without legs) x 1,220 x 740			
	in.	67-3/8 (65 without legs) x 36-1/4 x 29-3/16	67-3/8 (65 without legs) x 36-1/4 x 29-3/16	67-3/8 (65 without legs) x 48-1/16 x 29-3/16			
Protection devices	High pressure protection	High pressure sensor, High pressure switch at 4.15 MPa (601 psi)	High pressure sensor, High pressure switch at 4.15 MPa (601 psi)	High pressure sensor, High pressure switch at 4.15 MPa (601 psi)			
	Inverter circuit (COMP/FAN)	Over-heat protection, Over-current protection	Over-heat protection, Over-current protection	Over-heat protection, Over-current protection			
	Compressor	Over-heat protection	Over-heat protection	Over-heat protection			
	Fan motor	Over-current protection	Over-current protection	Over-current protection			
Refrigerant	Type x original charge	R410A x 7.5 kg (17 lbs)	R410A x 7.5 kg (17 lbs)	R410A x 10.3 kg (23 lbs)			
Net weight	kg (lbs)	208 (459)	208 (459)	252 (556)			
Heat exchanger	Salt-resistant cross fin & aluminium tube		Salt-resistant cross fin & aluminium tube	Salt-resistant cross fin & aluminium tube			
Optional parts	Joint: CMY-Y102SS/LS-G2		Joint: CMY-Y102SS/LS-G2	Joint: CMY-Y102SS/LS-G2			
	Header: CMY-Y104/108/1010-G		Header: CMY-Y104/108/1010-G	Header: CMY-Y104/108/1010-G			

### Notes:

\*1,\*2 Nominal conditions

	Indoor	Outdoor	Pipe length	Level difference
Cooling	27°C DB/19°C WB (81°F DB/66°F WB)	35°C DB/24°C WB (95°F DB/75°F WB)	7.5m (24-9/16ft.)	0m (0ft.)
Heating	20°C DB/68°F DB)	7°C DB/6°C WB(45°F DB/43°F WB)	7.5m (24-9/16ft.)	0m (0ft.)

\*3 External static pressure option is available (30Pa, 60Pa / 3.1mmH<sub>2</sub>O, 6.1mmH<sub>2</sub>O).

\*Nominal condition \*1,\*2 are subject to JIS B8615-1.

\*Due to continuing improvement, above specification may be subject to change without notice.



# OUTDOOR UNIT

## Y Series - High COP

### PUHY-EP YLM-A(-BS)



## ► Specifications

Model	PUHY-EP350YLM-A (-BS)		PUHY-EP400YLM-A (-BS)		PUHY-EP450YLM-A (-BS)		
Power source	3-phase 4-wire 380-400-415 V 50/60 Hz		3-phase 4-wire 380-400-415 V 50/60 Hz		3-phase 4-wire 380-400-415 V 50/60 Hz		
Cooling capacity (Nominal)	*1 kW	40.0	45.0		50.0		
	*1 BTU / h	136,500	153,500		170,600		
	Power input kW	11.69	12.26		14.79		
	Current input A	19.7-18.7-18.0	20.6-19.6-18.9		24.9-23.7-22.8		
EER	kW / kW	3.42	3.67		3.38		
	W.B.	15.0-24.0°C (59-75°F)	15.0-24.0°C (59-75°F)		15.0-24.0°C (59-75°F)		
Temp. range of cooling	Outdoor D.B.	-5.0-52.0°C (23-126°F)	-5.0-52.0°C (23-126°F)		-5.0-52.0°C (23-126°F)		
	W.B.	-5.0-52.0°C (23-126°F)	-5.0-52.0°C (23-126°F)		-5.0-52.0°C (23-126°F)		
Heating capacity (Nominal)	*2 kW	45.0	50.0		56.0		
	*2 BTU / h	153,500	170,600		191,100		
	Power input kW	12.53	13.15		16.09		
	Current input A	21.1-20.0-19.3	22.1-21.0-20.3		27.1-25.8-24.8		
COP	kW / kW	3.59	3.80		3.48		
	D.B.	15.0-27.0°C (59-81°F)	15.0-27.0°C (59-81°F)		15.0-27.0°C (59-81°F)		
Temp. range of heating	Outdoor W.B.	-20.0-15.5°C (-4-60°F)	-20.0-15.5°C (-4-60°F)		-20.0-15.5°C (-4-60°F)		
	W.B.	-20.0-15.5°C (-4-60°F)	-20.0-15.5°C (-4-60°F)		-20.0-15.5°C (-4-60°F)		
Indoor unit connectable	Total capacity	50-130% of outdoor unit capacity	50-130% of outdoor unit capacity		50-130% of outdoor unit capacity		
	Model / Quantity	P15-P250/1-30	P15-P250/1-34		P15-P250/1-39		
Sound pressure level (measured in anechoic room)	dB <A>	61	62.5		63		
Sound power level (measured in anechoic room)	dB <A>	82.5	82.5		83		
Refrigerant piping diameter	Liquid pipe mm (in.)	12.7 (1/2) Brazed	12.7 (1/2) Brazed		15.88 (5/8) Brazed		
	Gas pipe mm (in.)	28.58 (1-1/8) Brazed	28.58 (1-1/8) Brazed		28.58 (1-1/8) Brazed		
FAN	Type x Quantity	Propeller fan x 1	Propeller fan x 2		Propeller fan x 2		
	Air flow rate	m <sup>3</sup> /min	200	320		370	
		L/s	3,333	5,333		6,167	
		cfm	7,062	11,299		13,065	
	Driving mechanism	Inverter-control, Direct-driven by motor	Inverter-control, Direct-driven by motor		Inverter-control, Direct-driven by motor		
	Motor output kW	0.92 x 1	0.92 x 2		0.92 x 2		
*3 External static press.	0 Pa (0 mmH <sub>2</sub> O)	0 Pa (0 mmH <sub>2</sub> O)		0 Pa (0 mmH <sub>2</sub> O)			
Compressor	Type x Quantity	Inverter scroll hermetic compressor	Inverter scroll hermetic compressor		Inverter scroll hermetic compressor		
	Starting method	Inverter	Inverter		Inverter		
	Motor output kW	10.5	10.9		12.4		
	Case heater kW	-	-		-		
External finish		Pre-coated galvanized steel sheets (+powder coating for -BS type) <MUNSELL 5Y 8/1 or similar>	Pre-coated galvanized steel sheets (+powder coating for -BS type) <MUNSELL 5Y 8/1 or similar>		Pre-coated galvanized steel sheets (+powder coating for -BS type) <MUNSELL 5Y 8/1 or similar>		
External dimension HxWxD	mm	1,710 (1,650 without legs) x 1,220 x 740	1,710 (1,650 without legs) x 1,750 x 740		1,710 (1,650 without legs) x 1,750 x 740		
	in.	67-3/8 (65 without legs) x 48-1/16 x 29-3/16	67-3/8 (65 without legs) x 68-15/16 x 29-3/16		67-3/8 (65 without legs) x 68-15/16 x 29-3/16		
Protection devices	High pressure protection	High pressure sensor, High pressure switch at 4.15 MPa (601 psi)	High pressure sensor, High pressure switch at 4.15 MPa (601 psi)		High pressure sensor, High pressure switch at 4.15 MPa (601 psi)		
	Inverter circuit (COMP./FAN)	Over-heat protection, Over-current protection	Over-heat protection, Over-current protection		Over-heat protection, Over-current protection		
	Compressor	Over-heat protection	Over-heat protection		Over-heat protection		
	Fan motor	Over-current protection	Over-current protection		Over-current protection		
Refrigerant	Type x original charge	R410A x 10.3 kg (23 lbs)	R410A x 11.8 kg (27 lbs)		R410A x 11.8 kg (27 lbs)		
Net weight	kg (lbs)	252 (556)	318 (702)		318 (702)		
Heat exchanger		Salt-resistant cross fin & aluminium tube	Salt-resistant cross fin & aluminium tube		Salt-resistant cross fin & aluminium tube		
Optional parts		Joint: CMY-Y102SS/LS-G2, CMY-Y202S-G2 Header: CMY-Y104/108/1010-G	Joint: CMY-Y102SS/LS-G2, CMY-Y202S-G2 Header: CMY-Y104/108/1010-G		Joint: CMY-Y102SS/LS-G2, CMY-Y202S-G2 Header: CMY-Y104/108/1010-G		

### Notes:

\*1, \*2 Nominal conditions

	Indoor	Outdoor	Pipe length	Level difference
Cooling	27°C DB/19°C WB (81°F DB/66°F WB)	35°C DB/24°C WB (95°F DB/75°F WB)	7.5m (24-9/16ft.)	0m (0ft.)
Heating	20°C DB/68°F DB)	7°C DB/6°C WB(45°F DB/43°F WB)	7.5m (24-9/16ft.)	0m (0ft.)

\*3 External static pressure option is available (30Pa, 60Pa / 3.1mmH<sub>2</sub>O, 6.1mmH<sub>2</sub>O).

\*Nominal condition \*1, \*2 are subject to JIS B8615-1.

\*Due to continuing improvement, above specification may be subject to change without notice.



# OUTDOOR UNIT

## Y Series - High COP

### PUHY-EP YSLM-A(-BS)



## ► Specifications

Model	PUHY-EP500YSLM-A (-BS)		PUHY-EP550YSLM-A (-BS)		PUHY-EP600YSLM-A (-BS)	
Power source	3-phase 4-wire 380-400-415 V 50/60 Hz		3-phase 4-wire 380-400-415 V 50/60 Hz		3-phase 4-wire 380-400-415 V 50/60 Hz	
Cooling capacity (Nominal)	*1 kW	56.0	63.0	69.0	69.0	69.0
	*1 BTU / h	191,100	215,000	235,400	235,400	235,400
	Power input kW	14.50	16.62	18.59	18.59	18.59
	Current input A	24.4-23.2-22.4	28.0-26.6-25.6	31.3-29.8-28.7	31.3-29.8-28.7	31.3-29.8-28.7
	EER kW / kW	3.86	3.79	3.71	3.71	3.71
Temp. range of cooling	Indoor W.B.	15.0~24.0°C (59~75°F)	15.0~24.0°C (59~75°F)	15.0~24.0°C (59~75°F)	15.0~24.0°C (59~75°F)	15.0~24.0°C (59~75°F)
	Outdoor D.B.	-5.0~52.0°C (23~126°F)	-5.0~52.0°C (23~126°F)	-5.0~52.0°C (23~126°F)	-5.0~52.0°C (23~126°F)	-5.0~52.0°C (23~126°F)
Heating capacity (Nominal)	*2 kW	63.0	69.0	76.5	76.5	76.5
	*2 BTU / h	215,000	235,400	261,000	261,000	261,000
	Power input kW	16.15	17.73	19.66	19.66	19.66
	Current input A	27.2-25.9-24.9	29.9-28.4-27.4	33.1-31.5-30.3	33.1-31.5-30.3	33.1-31.5-30.3
	COP kW / kW	3.90	3.89	3.89	3.89	3.89
Temp. range of heating	Indoor D.B.	15.0~27.0°C (59~81°F)	15.0~27.0°C (59~81°F)	15.0~27.0°C (59~81°F)	15.0~27.0°C (59~81°F)	15.0~27.0°C (59~81°F)
	Outdoor W.B.	-20.0~15.5°C (-4~60°F)	-20.0~15.5°C (-4~60°F)	-20.0~15.5°C (-4~60°F)	-20.0~15.5°C (-4~60°F)	-20.0~15.5°C (-4~60°F)
Indoor unit connectable	Total capacity	50~130% of outdoor unit capacity	50~130% of outdoor unit capacity	50~130% of outdoor unit capacity	50~130% of outdoor unit capacity	50~130% of outdoor unit capacity
	Model / Quantity	P15~P250/1~43	P15~P250/2~47	P15~P250/2~50	P15~P250/2~50	P15~P250/2~50
Sound pressure level (measured in anechoic room)	dB <A>	63	63.5	64	64	64
Sound power level (measured in anechoic room)	dB <A>	83	84.5	85	85	85
Refrigerant piping diameter	Liquid pipe mm (in.)	15.88 (5/8) Brazed	15.88 (5/8) Brazed	15.88 (5/8) Brazed	15.88 (5/8) Brazed	15.88 (5/8) Brazed
	Gas pipe mm (in.)	28.58 (1-1/8) Brazed	28.58 (1-1/8) Brazed	28.58 (1-1/8) Brazed	28.58 (1-1/8) Brazed	28.58 (1-1/8) Brazed

### Set Model

Model	PUHY-EP250YLM-A (-BS)	PUHY-EP250YLM-A (-BS)	PUHY-EP250YLM-A (-BS)	PUHY-EP300YLM-A (-BS)	PUHY-EP300YLM-A (-BS)	PUHY-EP300YLM-A (-BS)	
FAN	Type x Quantity	Propeller fan x 1	Propeller fan x 1	Propeller fan x 1	Propeller fan x 1	Propeller fan x 1	
	Air flow rate	m <sup>3</sup> /min	175	175	175	200	200
		L/s	2,917	2,917	2,917	3,333	3,333
		cfm	6,179	6,179	6,179	7,062	7,062
	Driving mechanism	Inverter-control, Direct-driven by motor		Inverter-control, Direct-driven by motor		Inverter-control, Direct-driven by motor	
	Motor output kW	0.92 x 1	0.92 x 1	0.92 x 1	0.92 x 1	0.92 x 1	0.92 x 1
	*3 External static press.	0 Pa (0 mmH <sub>2</sub> O)	0 Pa (0 mmH <sub>2</sub> O)	0 Pa (0 mmH <sub>2</sub> O)	0 Pa (0 mmH <sub>2</sub> O)	0 Pa (0 mmH <sub>2</sub> O)	0 Pa (0 mmH <sub>2</sub> O)
Compressor	Type x Quantity	Inverter scroll hermetic compressor		Inverter scroll hermetic compressor		Inverter scroll hermetic compressor	
	Starting method	Inverter	Inverter	Inverter	Inverter	Inverter	Inverter
	Motor output kW	6.9	6.9	6.9	8.1	8.1	8.1
	Case heater kW	-	-	-	-	-	-
External finish	Pre-coated galvanized steel sheets (+powder coating for -BS type) <MUNSELL 5Y 8/1 or similar>		Pre-coated galvanized steel sheets (+powder coating for -BS type) <MUNSELL 5Y 8/1 or similar>		Pre-coated galvanized steel sheets (+powder coating for -BS type) <MUNSELL 5Y 8/1 or similar>		
External dimension HxWxD	mm	1,710 (1,650 without legs) x 920 x 740	1,710 (1,650 without legs) x 920 x 740	1,710 (1,650 without legs) x 920 x 740	1,710 (1,650 without legs) x 1,220 x 740	1,710 (1,650 without legs) x 1,220 x 740	
	in.	67-3/8 (65 without legs) x 36-1/4 x 29-3/16	67-3/8 (65 without legs) x 36-1/4 x 29-3/16	67-3/8 (65 without legs) x 36-1/4 x 29-3/16	67-3/8 (65 without legs) x 48-1/16 x 29-3/16	67-3/8 (65 without legs) x 48-1/16 x 29-3/16	
Protection devices	High pressure protection	High pressure sensor, High pressure switch at 4.15 MPa (601 psi)		High pressure sensor, High pressure switch at 4.15 MPa (601 psi)		High pressure sensor, High pressure switch at 4.15 MPa (601 psi)	
	Inverter circuit (COMP./FAN)	Over-heat protection, Over-current protection		Over-heat protection, Over-current protection		Over-heat protection, Over-current protection	
	Compressor	Over-heat protection   Over-heat protection		Over-heat protection   Over-heat protection		Over-heat protection   Over-heat protection	
	Fan motor	Over-current protection		Over-current protection		Over-current protection	
Refrigerant	Type x original charge	R410A x 7.5 kg (17 lbs)	R410A x 7.5 kg (17 lbs)	R410A x 7.5 kg (17 lbs)	R410A x 10.3 kg (23 lbs)	R410A x 10.3 kg (23 lbs)	
Net weight	kg (lbs)	208 (459)	208 (459)	208 (459)	252 (556)	252 (556)	
Heat exchanger		Salt-resistant cross fin & aluminium tube		Salt-resistant cross fin & aluminium tube		Salt-resistant cross fin & aluminium tube	
Pipe between unit and distributor	Liquid pipe mm (in.)	9.52 (3/8) Brazed	9.52 (3/8) Brazed	9.52 (3/8) Brazed	12.7 (1/2) Brazed	12.7 (1/2) Brazed	
	Gas pipe mm (in.)	22.2 (7/8) Brazed	22.2 (7/8) Brazed	22.2 (7/8) Brazed	28.58 (1-1/8) Brazed	28.58 (1-1/8) Brazed	
Optional parts		Outdoor Twinning kit: CMY-Y100VBK3 Joint: CMY-Y102SS/LS-G2, CMY-Y202S-G2 Header: CMY-Y104/108/1010-G		Outdoor Twinning kit: CMY-Y100VBK3 Joint: CMY-Y102SS/LS-G2, CMY-Y202S-G2 Header: CMY-Y104/108/1010-G		Outdoor Twinning kit: CMY-Y100VBK3 Joint: CMY-Y102SS/LS-G2, CMY-Y202S-G2 Header: CMY-Y104/108/1010-G	

### Notes:

\*1,\*2 Nominal conditions

	Indoor	Outdoor	Pipe length	Level difference
Cooling	27°C DB/19°C WB (81°F DB/66°F WB)	35°C DB/24°C WB (95°F DB/75°F WB)	7.5m (24-9/16ft.)	0m (0ft.)
Heating	20°C DB/68°F DB)	7°C DB/6°C WB(45°F DB/43°F WB)	7.5m (24-9/16ft.)	0m (0ft.)

\*3 External static pressure option is available (30Pa, 60Pa / 3.1mmH<sub>2</sub>O, 6.1mmH<sub>2</sub>O).

\*Nominal condition \*1,\*2 are subject to JIS B8615-1.

\*Due to continuing improvement, above specification may be subject to change without notice.



# OUTDOOR UNIT

## Y Series - High COP

### PUHY-EP YSLM-A(-BS)



## ► Specifications

Model			PUHY-EP650YSLM-A (-BS)			PUHY-EP700YSLM-A (-BS)		
Power source			3-phase 4-wire 380-400-415 V 50/60 Hz			3-phase 4-wire 380-400-415 V 50/60 Hz		
Cooling capacity (Nominal)	*1	kW	73.0			80.0		
	*1	BTU / h	249,100			273,000		
		kW	18.15			20.15		
		A	30.6-29.1-28.0			34.0-32.3-31.1		
		kW / kW	4.02			3.97		
Temp. range of cooling	Indoor	W.B.	15.0~24.0°C (59~75°F)			15.0~24.0°C (59~75°F)		
	Outdoor	D.B.	-5.0~52.0°C (23~126°F)			-5.0~52.0°C (23~126°F)		
Heating capacity (Nominal)	*2	kW	81.5			88.0		
	*2	BTU / h	278,100			300,300		
		kW	20.07			21.67		
		A	33.8-32.1-31.0			36.5-34.7-33.4		
		kW / kW	4.06			4.06		
Temp. range of heating	Indoor	D.B.	15.0~27.0°C (59~81°F)			15.0~27.0°C (59~81°F)		
	Outdoor	W.B.	-20.0~15.5°C (-4~60°F)			-20.0~15.5°C (-4~60°F)		
Indoor unit connectable	Total capacity		50~130% of outdoor unit capacity			50~130% of outdoor unit capacity		
	Model / Quantity		P15~P250/2~50			P15~P250/2~50		
Sound pressure level (measured in anechoic room)	dB <A>		63			63.5		
Sound power level (measured in anechoic room)	dB <A>		84.5			85.5		
Refrigerant piping diameter	Liquid pipe	mm (in.)	15.88 (5/8) Brazed			19.05 (3/4) Brazed		
	Gas pipe	mm (in.)	28.58 (1-1/8) Brazed			34.93 (1-3/8) Brazed		
<b>Set Model</b>								
Model			PUHY-EP200YLM-A (-BS)	PUHY-EP200YLM-A (-BS)	PUHY-EP250YLM-A (-BS)	PUHY-EP200YLM-A (-BS)	PUHY-EP200YLM-A (-BS)	PUHY-EP300YLM-A (-BS)
FAN	Type x Quantity		Propeller fan x 1		Propeller fan x 1		Propeller fan x 1	
	Air flow rate	m <sup>3</sup> /min	175		175		175	
		L/s	2,917		2,917		2,917	
		cfm	6,179		6,179		6,179	
	Driving mechanism		Inverter-control, Direct-driven by motor					
	Motor output	kW	0.92 x 1		0.92 x 1		0.92 x 1	
*3	External static press.	0 Pa (0 mmH <sub>2</sub> O)		0 Pa (0 mmH <sub>2</sub> O)		0 Pa (0 mmH <sub>2</sub> O)		
Compressor	Type x Quantity		Inverter scroll hermetic compressor			Inverter scroll hermetic compressor		
	Starting method		Inverter		Inverter		Inverter	
	Motor output	kW	5.6		6.9		5.6	
	Case heater	kW	-		-		-	
External finish			Pre-coated galvanized steel sheets (+powder coating for -BS type) <MUNSELL 5Y 8/1 or similar>			Pre-coated galvanized steel sheets (+powder coating for -BS type) <MUNSELL 5Y 8/1 or similar>		
External dimension HxWxD	mm		1,710 (1,650 without legs) x 920 x 740		1,710 (1,650 without legs) x 920 x 740		1,710 (1,650 without legs) x 920 x 740	
	in.		67-3/8 (65 without legs) x 36-1/4 x 29-3/16		67-3/8 (65 without legs) x 36-1/4 x 29-3/16		67-3/8 (65 without legs) x 36-1/4 x 29-3/16	
Protection devices	High pressure protection		High pressure sensor, High pressure switch at 4.15 MPa (601 psi)			High pressure sensor, High pressure switch at 4.15 MPa (601 psi)		
	Inverter circuit (COMP./FAN)		Over-heat protection, Over-current protection			Over-heat protection, Over-current protection		
	Compressor		Over-heat protection		Over-heat protection		Over-heat protection	
	Fan motor		Over-current protection			Over-current protection		
Refrigerant	Type x original charge		R410A x 7.5 kg (17 lbs)		R410A x 7.5 kg (17 lbs)		R410A x 10.3 kg (23 lbs)	
Net weight	kg (lbs)		208 (459)		208 (459)		252 (556)	
Heat exchanger			Salt-resistant cross fin & aluminium tube					
Pipe between unit and distributor	Liquid pipe	mm (in.)	9.52 (3/8) Brazed		9.52 (3/8) Brazed		12.7 (1/2) Brazed	
	Gas pipe	mm (in.)	22.2 (7/8) Brazed		22.2 (7/8) Brazed		28.58 (1-1/8) Brazed	
Optional parts			Outdoor Twinning kit: CMY-Y300VBK3 Joint: CMY-Y102SS/LS-G2, CMY-Y202/302S-G2 Header: CMY-Y104/108/1010-G			Outdoor Twinning kit: CMY-Y300VBK3 Joint: CMY-Y102SS/LS-G2, CMY-Y202/302S-G2 Header: CMY-Y104/108/1010-G		

### Notes:

\*1,\*2 Nominal conditions

	Indoor	Outdoor	Pipe length	Level difference
Cooling	27°C DB/19°C WB (81°F DB/66°F WB)	35°C DB/24°C WB (95°F DB/75°F WB)	7.5m (24-9/16ft.)	0m (0ft.)
Heating	20°C DB/68°F DB)	7°C DB/6°C WB(45°F DB/43°F WB)	7.5m (24-9/16ft.)	0m (0ft.)

\*3 External static pressure option is available (30Pa, 60Pa / 3.1mmH<sub>2</sub>O, 6.1mmH<sub>2</sub>O).

\*Nominal condition \*1,\*2 are subject to JIS B8615-1.

\*Due to continuing improvement, above specification may be subject to change without notice.



Outdoor Unit



# OUTDOOR UNIT

## Y Series - High COP

### PUHY-EP YSLM-A(-BS)



## ► Specifications

Model			PUHY-EP750YSLM-A (-BS)			PUHY-EP800YSLM-A (-BS)				
Power source			3-phase 4-wire 380-400-415 V 50/60 Hz			3-phase 4-wire 380-400-415 V 50/60 Hz				
Cooling capacity (Nominal)	*1	kW	85.0			90.0				
	*1	BTU / h	290,000			307,100				
		Power input kW	21.85			23.43				
		Current input A	36.8-35.0-33.7			39.5-37.5-36.2				
		EER kW / kW	3.89			3.84				
Temp. range of cooling	Indoor	W.B.	15.0~24.0°C (59~75°F)			15.0~24.0°C (59~75°F)				
	Outdoor	D.B.	-5.0~52.0°C (23~126°F)			-5.0~52.0°C (23~126°F)				
Heating capacity (Nominal)	*2	kW	95.0			100.0				
	*2	BTU / h	324,100			341,200				
		Power input kW	23.92			25.18				
		Current input A	40.3-38.3-36.9			42.5-40.3-38.9				
		COP kW / kW	3.97			3.97				
Temp. range of heating	Indoor	D.B.	15.0~27.0°C (59~81°F)			15.0~27.0°C (59~81°F)				
	Outdoor	W.B.	-20.0~15.5°C (-4~60°F)			-20.0~15.5°C (-4~60°F)				
Indoor unit connectable	Total capacity		50~130% of outdoor unit capacity			50~130% of outdoor unit capacity				
	Model / Quantity		P15~P250/2~50			P15~P250/2~50				
Sound pressure level (measured in anechoic room)		dB <A>	64.5			65				
Sound power level (measured in anechoic room)		dB <A>	85.5			86.5				
Refrigerant piping diameter	Liquid pipe	mm (in.)	19.05 (3/4) Brazed			19.05 (3/4) Brazed				
	Gas pipe	mm (in.)	34.93 (1-3/8) Brazed			34.93 (1-3/8) Brazed				
<b>Set Model</b>										
Model			PUHY-EP200YLM-A (-BS)	PUHY-EP250YLM-A (-BS)	PUHY-EP300YLM-A (-BS)	PUHY-EP200YLM-A (-BS)	PUHY-EP300YLM-A (-BS)	PUHY-EP300YLM-A (-BS)		
FAN	Type x Quantity		Propeller fan x 1		Propeller fan x 1		Propeller fan x 1		Propeller fan x 1	
	Air flow rate	m <sup>3</sup> /min	175		175		200		175	
		L/s	2,917		2,917		3,333		2,917	
		cfm	6,179		6,179		7,062		6,179	
	Driving mechanism		Inverter-control, Direct-driven by motor						Inverter-control, Direct-driven by motor	
	Motor output		0.92 x 1		0.92 x 1		0.92 x 1		0.92 x 1	
*3 External static press.		0 Pa (0 mmH <sub>2</sub> O)		0 Pa (0 mmH <sub>2</sub> O)		0 Pa (0 mmH <sub>2</sub> O)		0 Pa (0 mmH <sub>2</sub> O)		
Compressor	Type x Quantity		Inverter scroll hermetic compressor						Inverter scroll hermetic compressor	
	Starting method		Inverter		Inverter		Inverter		Inverter	
	Motor output		5.6		6.9		8.1		5.6	
	Case heater		-		-		-		-	
External finish			Pre-coated galvanized steel sheets (+powder coating for -BS type) <MUNSELL 5Y 8/1 or similar>			Pre-coated galvanized steel sheets (+powder coating for -BS type) <MUNSELL 5Y 8/1 or similar>				
External dimension HxWxD	mm		1,710 (1,650 without legs) x 920 x 740		1,710 (1,650 without legs) x 920 x 740		1,710 (1,650 without legs) x 1,220 x 740		1,710 (1,650 without legs) x 1,220 x 740	
	in.		67-3/8 (65 without legs) x 36-1/4 x 29-3/16		67-3/8 (65 without legs) x 36-1/4 x 29-3/16		67-3/8 (65 without legs) x 48-1/16 x 29-3/16		67-3/8 (65 without legs) x 48-1/16 x 29-3/16	
Protection devices	High pressure protection		High pressure sensor, High pressure switch at 4.15 MPa (601 psi)						High pressure sensor, High pressure switch at 4.15 MPa (601 psi)	
	Inverter circuit (COMP/FAN)		Over-heat protection, Over-current protection						Over-heat protection, Over-current protection	
	Compressor		Over-heat protection		Over-heat protection		Over-heat protection		Over-heat protection	
	Fan motor		Over-current protection						Over-current protection	
Refrigerant	Type x original charge		R410A x 7.5 kg (17 lbs)		R410A x 7.5 kg (17 lbs)		R410A x 10.3 kg (23 lbs)		R410A x 7.5 kg (17 lbs)	
Net weight	kg (lbs)		208 (459)		208 (459)		252 (556)		208 (459)	
Heat exchanger			Salt-resistant cross fin & aluminium tube						Salt-resistant cross fin & aluminium tube	
Pipe between unit and distributor	Liquid pipe	mm (in.)	9.52 (3/8) Brazed		9.52 (3/8) Brazed		12.7 (1/2) Brazed		9.52 (3/8) Brazed	
	Gas pipe	mm (in.)	22.2 (7/8) Brazed		22.2 (7/8) Brazed		28.58 (1-1/8) Brazed		22.2 (7/8) Brazed	
Optional parts			Outdoor Twinning kit: CMY-Y300VBK3 Joint: CMY-Y102SS/LS-G2, CMY-Y202/302S-G2 Header: CMY-Y104/108/1010-G						Outdoor Twinning kit: CMY-Y300VBK3 Joint: CMY-Y102SS/LS-G2, CMY-Y202/302S-G2 Header: CMY-Y104/108/1010-G	

### Notes:

\*1,\*2 Nominal conditions

	Indoor	Outdoor	Pipe length	Level difference
Cooling	27°C DB/19°C WB (81°F DB/66°F WB)	35°C DB/24°C WB (95°F DB/75°F WB)	7.5m (24-9/16ft.)	0m (0ft.)
Heating	20°C DB/68°F DB)	7°C DB/6°C WB(45°F DB/43°F WB)	7.5m (24-9/16ft.)	0m (0ft.)

\*3 External static pressure option is available (30Pa, 60Pa / 3.1mmH<sub>2</sub>O, 6.1mmH<sub>2</sub>O).

\*Nominal condition \*1,\*2 are subject to JIS B8615-1.

\*Due to continuing improvement, above specification may be subject to change without notice.



# OUTDOOR UNIT

## Y Series - High COP

### PUHY-EP YSLM-A(-BS)



## ► Specifications

Model			PUHY-EP850YSLM-A (-BS)				PUHY-EP900YSLM-A (-BS)			
Power source			3-phase 4-wire 380-400-415 V 50/60 Hz				3-phase 4-wire 380-400-415 V 50/60 Hz			
Cooling capacity (Nominal)	*1	kW	96.0				101.0			
	*1	BTU / h	327,600				344,600			
		Power input kW	25.53				27.22			
		Current input A	43.0-40.9-39.4				45.9-43.6-42.0			
	EER	kW / kW	3.76				3.71			
Temp. range of cooling	Indoor	W.B.	15.0~24.0°C (59~75°F)				15.0~24.0°C (59~75°F)			
	Outdoor	D.B.	-5.0~52.0°C (23~126°F)				-5.0~52.0°C (23~126°F)			
Heating capacity (Nominal)	*2	kW	108.0				113.0			
	*2	BTU / h	368,500				385,600			
		Power input kW	27.76				29.04			
		Current input A	46.8-44.5-42.9				49.0-46.5-44.8			
	COP	kW / kW	3.89				3.89			
Temp. range of heating	Indoor	D.B.	15.0~27.0°C (59~81°F)				15.0~27.0°C (59~81°F)			
	Outdoor	W.B.	-20.0~15.5°C (-4~60°F)				-20.0~15.5°C (-4~60°F)			
Indoor unit connectable	Total capacity		50~130% of outdoor unit capacity				50~130% of outdoor unit capacity			
	Model / Quantity		P15~P250/2~50				P15~P250/2~50			
Sound pressure level (measured in anechoic room)		dB <A>	65.5				66			
Sound power level (measured in anechoic room)		dB <A>	86.5				87			
Refrigerant piping diameter	Liquid pipe	mm (in.)	19.05 (3/4) Brazed				19.05 (3/4) Brazed			
	Gas pipe	mm (in.)	41.28 (1-5/8) Brazed				41.28 (1-5/8) Brazed			
<b>Set Model</b>										
Model			PUHY-EP250YLM-A (-BS)	PUHY-EP300YLM-A (-BS)	PUHY-EP300YLM-A (-BS)	PUHY-EP300YLM-A (-BS)	PUHY-EP300YLM-A (-BS)	PUHY-EP300YLM-A (-BS)	PUHY-EP300YLM-A (-BS)	
FAN	Type x Quantity		Propeller fan x 1		Propeller fan x 1		Propeller fan x 1		Propeller fan x 1	
	Air flow rate	m <sup>3</sup> /min	175		200		200		200	
		L/s	2,917		3,333		3,333		3,333	
		cfm	6,179		7,062		7,062		7,062	
	Driving mechanism		Inverter-control, Direct-driven by motor		Inverter-control, Direct-driven by motor		Inverter-control, Direct-driven by motor		Inverter-control, Direct-driven by motor	
	Motor output	kW	0.92 x 1		0.92 x 1		0.92 x 1		0.92 x 1	
*3	External static press.		0 Pa (0 mmH <sub>2</sub> O)		0 Pa (0 mmH <sub>2</sub> O)		0 Pa (0 mmH <sub>2</sub> O)		0 Pa (0 mmH <sub>2</sub> O)	
Compressor	Type x Quantity		Inverter scroll hermetic compressor				Inverter scroll hermetic compressor			
	Starting method		Inverter		Inverter		Inverter		Inverter	
	Motor output	kW	6.9		8.1		8.1		8.1	
	Case heater	kW	-		-		-		-	
External finish			Pre-coated galvanized steel sheets (+powder coating for -BS type) <MUNSELL 5Y 8/1 or similar>				Pre-coated galvanized steel sheets (+powder coating for -BS type) <MUNSELL 5Y 8/1 or similar>			
External dimension HxWxD	mm		1,710 (1,650 without legs) x 920 x 740		1,710 (1,650 without legs) x 1,220 x 740		1,710 (1,650 without legs) x 1,220 x 740		1,710 (1,650 without legs) x 1,220 x 740	
	in.		67-3/8 (65 without legs) x 36-1/4 x 29-3/16		67-3/8 (65 without legs) x 48-1/16 x 29-3/16		67-3/8 (65 without legs) x 48-1/16 x 29-3/16		67-3/8 (65 without legs) x 48-1/16 x 29-3/16	
Protection devices	High pressure protection		High pressure sensor, High pressure switch at 4.15 MPa (601 psi)				High pressure sensor, High pressure switch at 4.15 MPa (601 psi)			
	Inverter circuit (COMP./FAN)		Over-heat protection, Over-current protection				Over-heat protection, Over-current protection			
	Compressor		Over-heat protection		Over-heat protection		Over-heat protection		Over-heat protection	
	Fan motor		Over-current protection				Over-current protection			
Refrigerant	Type x original charge		R410A x 7.5 kg (17 lbs)		R410A x 10.3 kg (23 lbs)		R410A x 10.3 kg (23 lbs)		R410A x 10.3 kg (23 lbs)	
Net weight	kg (lbs)		208 (459)		252 (556)		252 (556)		252 (556)	
Heat exchanger			Salt-resistant cross fin & aluminium tube				Salt-resistant cross fin & aluminium tube			
Pipe between unit and distributor	Liquid pipe	mm (in.)	9.52 (3/8) Brazed		12.7 (1/2) Brazed		12.7 (1/2) Brazed		12.7 (1/2) Brazed	
	Gas pipe	mm (in.)	22.2 (7/8) Brazed		28.58 (1-1/8) Brazed		28.58 (1-1/8) Brazed		28.58 (1-1/8) Brazed	
Optional parts			Outdoor Twinning kit: CMY-Y300VBK3 Joint: CMY-Y102SS/LS-G2, CMY-Y202/302S-G2 Header: CMY-Y104/108/1010-G				Outdoor Twinning kit: CMY-Y300VBK3 Joint: CMY-Y102SS/LS-G2, CMY-Y202/302S-G2 Header: CMY-Y104/108/1010-G			

### Notes:

\*1, \*2 Nominal conditions

	Indoor	Outdoor	Pipe length	Level difference
Cooling	27°C DB/19°C WB (81°F DB/66°F WB)	35°C DB/24°C WB (95°F DB/75°F WB)	7.5m (24-9/16ft.)	0m (0ft.)
Heating	20°C DB(68°F DB)	7°C DB/6°C WB(45°F DB/43°F WB)	7.5m (24-9/16ft.)	0m (0ft.)

\*3 External static pressure option is available (30Pa, 60Pa / 3.1mmH<sub>2</sub>O, 6.1mmH<sub>2</sub>O).

\*Nominal condition \*1, \*2 are subject to JIS B8615-1.

\*Due to continuing improvement, above specification may be subject to change without notice.



Outdoor Unit

# OUTDOOR UNIT

## Y Series - High COP

### PUHY-EP YSLM-A(-BS)



## ► Specifications

Model			PUHY-EP950YSLM-A (-BS)			PUHY-EP1000YSLM-A (-BS)		
Power source			3-phase 4-wire 380-400-415 V 50/60 Hz			3-phase 4-wire 380-400-415 V 50/60 Hz		
Cooling capacity (Nominal)	*1	kW	108.0			113.0		
	*1	BTU / h	368,500			385,600		
		Power input kW	30.33			31.04		
		Current input A	51.2-48.6-46.8			52.4-49.7-47.9		
		EER kW / kW	3.56			3.64		
Temp. range of cooling	Indoor	W.B.	15.0~24.0°C (59~75°F)			15.0~24.0°C (59~75°F)		
	Outdoor	D.B.	-5.0~52.0°C (23~126°F)			-5.0~52.0°C (23~126°F)		
Heating capacity (Nominal)	*2	kW	119.5			127.0		
	*2	BTU / h	407,700			433,300		
		Power input kW	32.03			33.50		
		Current input A	54.0-51.3-49.5			56.5-53.7-51.7		
		COP kW / kW	3.73			3.79		
Temp. range of heating	Indoor	D.B.	15.0~27.0°C (59~81°F)			15.0~27.0°C (59~81°F)		
	Outdoor	W.B.	-20.0~15.5°C (-4~60°F)			-20.0~15.5°C (-4~60°F)		
Indoor unit connectable	Total capacity		50~130% of outdoor unit capacity			50~130% of outdoor unit capacity		
	Model / Quantity		P15~P250/2~50			P15~P250/2~50		
Sound pressure level (measured in anechoic room)		dB <A>	66			66.5		
Sound power level (measured in anechoic room)		dB <A>	87			87		
Refrigerant piping diameter	Liquid pipe	mm (in.)	19.05 (3/4) Brazed			19.05 (3/4) Brazed		
	Gas pipe	mm (in.)	41.28 (1-5/8) Brazed			41.28 (1-5/8) Brazed		
<b>Set Model</b>								
Model			PUHY-EP300YLM-A (-BS)	PUHY-EP300YLM-A (-BS)	PUHY-EP350YLM-A (-BS)	PUHY-EP300YLM-A (-BS)	PUHY-EP300YLM-A (-BS)	PUHY-EP400YLM-A (-BS)
FAN	Type x Quantity		Propeller fan x 1	Propeller fan x 1	Propeller fan x 1	Propeller fan x 1	Propeller fan x 1	Propeller fan x 2
	Air flow rate	m <sup>3</sup> /min	200	200	200	200	200	320
		L/s	3,333	3,333	3,333	3,333	3,333	5,333
		cfm	7,062	7,062	7,062	7,062	7,062	11,299
	Driving mechanism		Inverter-control, Direct-driven by motor			Inverter-control, Direct-driven by motor		
	Motor output	kW	0.92 x 1	0.92 x 1	0.92 x 1	0.92 x 1	0.92 x 1	0.92 x 2
*3	External static press.	0 Pa (0 mmH <sub>2</sub> O)	0 Pa (0 mmH <sub>2</sub> O)	0 Pa (0 mmH <sub>2</sub> O)	0 Pa (0 mmH <sub>2</sub> O)	0 Pa (0 mmH <sub>2</sub> O)	0 Pa (0 mmH <sub>2</sub> O)	
Compressor	Type x Quantity		Inverter scroll hermetic compressor			Inverter scroll hermetic compressor		
	Starting method		Inverter	Inverter	Inverter	Inverter	Inverter	Inverter
	Motor output	kW	8.1	8.1	10.5	8.1	8.1	10.9
	Case heater	kW	-	-	-	-	-	-
External finish		Pre-coated galvanized steel sheets (+powder coating for -BS type) <MUNSELL 5Y 8/1 or similar>			Pre-coated galvanized steel sheets (+powder coating for -BS type) <MUNSELL 5Y 8/1 or similar>			
External dimension HxWxD	mm	1,710 (1,650 without legs) x 1,220 x 740	1,710 (1,650 without legs) x 1,220 x 740	1,710 (1,650 without legs) x 1,220 x 740	1,710 (1,650 without legs) x 1,220 x 740	1,710 (1,650 without legs) x 1,220 x 740	1,710 (1,650 without legs) x 1,750 x 740	
	in.	67-3/8 (65 without legs) x 48-1/16 x 29-3/16	67-3/8 (65 without legs) x 48-1/16 x 29-3/16	67-3/8 (65 without legs) x 48-1/16 x 29-3/16	67-3/8 (65 without legs) x 48-1/16 x 29-3/16	67-3/8 (65 without legs) x 48-1/16 x 29-3/16	67-3/8 (65 without legs) x 68-15/16 x 29-3/16	
Protection devices	High pressure protection		High pressure sensor, High pressure switch at 4.15 MPa (601 psi)			High pressure sensor, High pressure switch at 4.15 MPa (601 psi)		
	Inverter circuit (COMP/FAN)		Over-heat protection, Over-current protection			Over-heat protection, Over-current protection		
	Compressor		Over-heat protection			Over-heat protection		
	Fan motor		Over-current protection			Over-current protection		
Refrigerant	Type x original charge	R410A x 10.3 kg (23 lbs)	R410A x 10.3 kg (23 lbs)	R410A x 10.3 kg (23 lbs)	R410A x 10.3 kg (23 lbs)	R410A x 10.3 kg (23 lbs)	R410A x 11.8 kg (27 lbs)	
Net weight	kg (lbs)	252 (556)	252 (556)	252 (556)	252 (556)	252 (556)	318 (702)	
Heat exchanger		Salt-resistant cross fin & aluminium tube			Salt-resistant cross fin & aluminium tube			
Pipe between unit and distributor	Liquid pipe	mm (in.)	12.7 (1/2) Brazed	12.7 (1/2) Brazed	12.7 (1/2) Brazed	12.7 (1/2) Brazed	15.88 (5/8) Brazed	
	Gas pipe	mm (in.)	28.58 (1-1/8) Brazed	28.58 (1-1/8) Brazed	28.58 (1-1/8) Brazed	28.58 (1-1/8) Brazed	28.58 (1-1/8) Brazed	
Optional parts		Outdoor Twinning kit: CMY-Y300VBK3 Joint: CMY-Y102SS/LS-G2, CMY-Y202/302S-G2 Header: CMY-Y104/108/1010-G			Outdoor Twinning kit: CMY-Y300VBK3 Joint: CMY-Y102SS/LS-G2, CMY-Y202/302S-G2 Header: CMY-Y104/108/1010-G			

### Notes:

\*1, \*2 Nominal conditions

	Indoor	Outdoor	Pipe length	Level difference
Cooling	27°C DB/19°C WB (81°F DB/66°F WB)	35°C DB/24°C WB (95°F DB/75°F WB)	7.5m (24-9/16ft.)	0m (0ft.)
Heating	20°C DB(68°F DB)	7°C DB/6°C WB(45°F DB/43°F WB)	7.5m (24-9/16ft.)	0m (0ft.)

\*3 External static pressure option is available (30Pa, 60Pa / 3.1mmH<sub>2</sub>O, 6.1mmH<sub>2</sub>O).

\*Nominal condition \*1, \*2 are subject to JIS B8615-1.

\*Due to continuing improvement, above specification may be subject to change without notice.



# OUTDOOR UNIT

## Y Series - High COP

### PUHY-EP YSLM-A(-BS)



## ► Specifications

Model		PUHY-EP1050YSLM-A (-BS)			PUHY-EP1100YSLM-A (-BS)			
Power source		3-phase 4-wire 380-400-415 V 50/60 Hz			3-phase 4-wire 380-400-415 V 50/60 Hz			
Cooling capacity (Nominal)	*1 kW	118.0			124.0			
	*1 BTU / h	402,600			423,100			
	Power input kW	34.40			38.15			
	Current input A	58.0-55.1-53.1			64.4-61.1-58.9			
EER	kW / kW	3.43			3.25			
Temp. range of cooling	Indoor W.B.	15.0~24.0°C (59~75°F)			15.0~24.0°C (59~75°F)			
	Outdoor D.B.	-5.0~52.0°C (23~126°F)			-5.0~52.0°C (23~126°F)			
Heating capacity (Nominal)	*2 kW	132.0			140.0			
	*2 BTU / h	450,400			477,700			
	Power input kW	36.87			41.17			
	Current input A	62.2-59.1-56.9			69.5-66.0-63.6			
COP	kW / kW	3.58			3.40			
Temp. range of heating	Indoor D.B.	15.0~27.0°C (59~81°F)			15.0~27.0°C (59~81°F)			
	Outdoor W.B.	-20.0~15.5°C (-4~60°F)			-20.0~15.5°C (-4~60°F)			
Indoor unit connectable	Total capacity	50~130% of outdoor unit capacity			50~130% of outdoor unit capacity			
	Model / Quantity	P15~P250/3~50			P15~P250/3~50			
Sound pressure level (measured in anechoic room)	dB <A>	66.5			66.5			
Sound power level (measured in anechoic room)	dB <A>	87.5			87.5			
Refrigerant piping diameter	Liquid pipe mm (in.)	19.05 (3/4) Brazed			19.05 (3/4) Brazed			
	Gas pipe mm (in.)	41.28 (1-5/8) Brazed			41.28 (1-5/8) Brazed			
<b>Set Model</b>								
Model		PUHY-EP300YLM-A (-BS)	PUHY-EP350YLM-A (-BS)	PUHY-EP400YLM-A (-BS)	PUHY-EP350YLM-A (-BS)	PUHY-EP350YLM-A (-BS)	PUHY-EP400YLM-A (-BS)	
FAN	Type x Quantity	Propeller fan x 1		Propeller fan x 2	Propeller fan x 1		Propeller fan x 2	
	Air flow rate	m <sup>3</sup> /min	200		320	200		320
		L/s	3,333		5,333	3,333		5,333
		cfm	7,062		11,299	7,062		11,299
	Driving mechanism	Inverter-control, Direct-driven by motor				Inverter-control, Direct-driven by motor		
Motor output	kW	0.92 x 1	0.92 x 1	0.92 x 2	0.92 x 1	0.92 x 1	0.92 x 2	
*3 External static press.	Pa	0 Pa (0 mmH <sub>2</sub> O)		0 Pa (0 mmH <sub>2</sub> O)	0 Pa (0 mmH <sub>2</sub> O)		0 Pa (0 mmH <sub>2</sub> O)	
Compressor	Type x Quantity	Inverter scroll hermetic compressor				Inverter scroll hermetic compressor		
	Starting method	Inverter		Inverter	Inverter		Inverter	
	Motor output	kW	8.1	10.5	10.9	10.5	10.5	10.9
	Case heater	kW	-		-	-		-
External finish	Pre-coated galvanized steel sheets (+powder coating for -BS type) <MUNSELL 5Y 8/1 or similar>				Pre-coated galvanized steel sheets (+powder coating for -BS type) <MUNSELL 5Y 8/1 or similar>			
External dimension HxWxD	mm	1,710 (1,650 without legs) x 1,220 x 740	1,710 (1,650 without legs) x 1,220 x 740	1,710 (1,650 without legs) x 1,750 x 740	1,710 (1,650 without legs) x 1,220 x 740	1,710 (1,650 without legs) x 1,220 x 740	1,710 (1,650 without legs) x 1,750 x 740	
	in.	67-3/8 (65 without legs) x 48-1/16 x 29-3/16	67-3/8 (65 without legs) x 48-1/16 x 29-3/16	67-3/8 (65 without legs) x 68-15/16 x 29-3/16	67-3/8 (65 without legs) x 48-1/16 x 29-3/16	67-3/8 (65 without legs) x 48-1/16 x 29-3/16	67-3/8 (65 without legs) x 68-15/16 x 29-3/16	
Protection devices	High pressure protection	High pressure sensor, High pressure switch at 4.15 MPa (601 psi)				High pressure sensor, High pressure switch at 4.15 MPa (601 psi)		
	Inverter circuit (COMP/FAN)	Over-heat protection, Over-current protection				Over-heat protection, Over-current protection		
	Compressor	Over-heat protection		Over-heat protection	Over-heat protection		Over-heat protection	
Refrigerant	Type x original charge	R410A x 10.3 kg (23 lbs)	R410A x 10.3 kg (23 lbs)	R410A x 11.8 kg (27 lbs)	R410A x 10.3 kg (23 lbs)	R410A x 10.3 kg (23 lbs)	R410A x 11.8 kg (27 lbs)	
	Net weight	kg (lbs)	252 (556)	252 (556)	318 (702)	252 (556)	252 (556)	318 (702)
Heat exchanger	Salt-resistant cross fin & aluminium tube				Salt-resistant cross fin & aluminium tube			
Pipe between unit and distributor	Liquid pipe mm (in.)	12.7 (1/2) Brazed	12.7 (1/2) Brazed	15.88 (5/8) Brazed	12.7 (1/2) Brazed	12.7 (1/2) Brazed	15.88 (5/8) Brazed	
	Gas pipe mm (in.)	28.58 (1-1/8) Brazed	28.58 (1-1/8) Brazed	28.58 (1-1/8) Brazed	28.58 (1-1/8) Brazed	28.58 (1-1/8) Brazed	28.58 (1-1/8) Brazed	
Optional parts	Outdoor Twinning kit: CMY-Y300VBK3 Joint: CMY-Y102SS/LS-G2, CMY-Y202/302S-G2 Header: CMY-Y104/108/1010-G				Outdoor Twinning kit: CMY-Y300VBK3 Joint: CMY-Y102SS/LS-G2, CMY-Y202/302S-G2 Header: CMY-Y104/108/1010-G			

### Notes:

\*1,\*2 Nominal conditions

	Indoor	Outdoor	Pipe length	Level difference
Cooling	27°C DB/19°C WB (81°F DB/66°F WB)	35°C DB/24°C WB (95°F DB/75°F WB)	7.5m (24-9/16ft.)	0m (0ft.)
Heating	20°C DB(68°F DB)	7°C DB/6°C WB(45°F DB/43°F WB)	7.5m (24-9/16ft.)	0m (0ft.)

\*3 External static pressure option is available (30Pa, 60Pa / 3.1mmH<sub>2</sub>O, 6.1mmH<sub>2</sub>O).

\*Nominal condition \*1,\*2 are subject to JIS B8615-1.

\*Due to continuing improvement, above specification may be subject to change without notice.



# OUTDOOR UNIT Y Series - High COP PUHY-EP YSLM-A (-BS)



## ► Specifications

Model		PUHY-EP1150YSLM-A (-BS)			PUHY-EP1200YSLM-A (-BS)			
Power source		3-phase 4-wire 380-400-415 V 50/60 Hz			3-phase 4-wire 380-400-415 V 50/60 Hz			
Cooling capacity (Nominal)	*1 kW	130.0			136.0			
	*1 BTU / h	443,600			464,000			
	Power input kW	41.53			42.76			
	Current input A	70.1-66.6-64.1			72.1-68.5-66.0			
EER		3.13			3.18			
Temp. range of cooling	Indoor W.B.	15.0-24.0°C (59-75°F)			15.0-24.0°C (59-75°F)			
	Outdoor D.B.	-5.0-52.0°C (23-126°F)			-5.0-52.0°C (23-126°F)			
Heating capacity (Nominal)	*2 kW	145.0			150.0			
	*2 BTU / h	494,700			511,800			
	Power input kW	44.47			45.45			
	Current input A	75.0-71.3-68.7			76.7-72.8-70.2			
COP		3.26			3.30			
Temp. range of heating	Indoor D.B.	15.0-27.0°C (59-81°F)			15.0-27.0°C (59-81°F)			
	Outdoor W.B.	-20.0-15.5°C (-4-60°F)			-20.0-15.5°C (-4-60°F)			
Indoor unit connectable	Total capacity	50-130% of outdoor unit capacity			50-130% of outdoor unit capacity			
	Model / Quantity	P15-P250/3-50			P15-P250/3-50			
Sound pressure level (measured in anechoic room)	dB <A>	66.5			67			
Sound power level (measured in anechoic room)	dB <A>	87.5			87.5			
Refrigerant piping diameter	Liquid pipe mm (in.)	19.05 (3/4) Brazed			19.05 (3/4) Brazed			
	Gas pipe mm (in.)	41.28 (1-5/8) Brazed			41.28 (1-5/8) Brazed			
<b>Set Model</b>								
Model		PUHY-EP350YLM-A (-BS)	PUHY-EP350YLM-A (-BS)	PUHY-EP450YLM-A (-BS)	PUHY-EP350YLM-A (-BS)	PUHY-EP400YLM-A (-BS)	PUHY-EP450YLM-A (-BS)	
FAN	Type x Quantity	Propeller fan x 1		Propeller fan x 2	Propeller fan x 2		Propeller fan x 2	
	Air flow rate	m <sup>3</sup> /min	200		370	200		370
		L/s	3,333		6,167	3,333		6,167
		cfm	7,062		13,065	7,062		13,065
	Driving mechanism	Inverter-control, Direct-driven by motor						
	Motor output kW	0.92 x 1	0.92 x 1	0.92 x 2	0.92 x 1	0.92 x 2	0.92 x 2	
*3 External static press.	0 Pa (0 mmH <sub>2</sub> O)							
Compressor	Type x Quantity	Inverter scroll hermetic compressor			Inverter scroll hermetic compressor			
	Starting method	Inverter	Inverter	Inverter	Inverter	Inverter	Inverter	
	Motor output kW	10.5	10.5	12.4	10.5	10.9	12.4	
	Case heater kW	-						
External finish		Pre-coated galvanized steel sheets (+powder coating for -BS type) <MUNSELL 5Y 8/1 or similar>			Pre-coated galvanized steel sheets (+powder coating for -BS type) <MUNSELL 5Y 8/1 or similar>			
External dimension HxWxD	mm	1,710 (1,650 without legs) x 1,220 x 740	1,710 (1,650 without legs) x 1,220 x 740	1,710 (1,650 without legs) x 1,750 x 740	1,710 (1,650 without legs) x 1,220 x 740	1,710 (1,650 without legs) x 1,750 x 740	1,710 (1,650 without legs) x 1,750 x 740	
	in.	67-3/8 (65 without legs) x 48-1/16 x 29-3/16	67-3/8 (65 without legs) x 48-1/16 x 29-3/16	67-3/8 (65 without legs) x 68-15/16 x 29-3/16	67-3/8 (65 without legs) x 48-1/16 x 29-3/16	67-3/8 (65 without legs) x 68-15/16 x 29-3/16	67-3/8 (65 without legs) x 68-15/16 x 29-3/16	
Protection devices	High pressure protection	High pressure sensor, High pressure switch at 4.15 MPa (601 psi)			High pressure sensor, High pressure switch at 4.15 MPa (601 psi)			
	Inverter circuit (COMP/FAN)	Over-heat protection, Over-current protection						
	Compressor	Over-heat protection, Over-current protection						
Refrigerant	Type x original charge	R410A x 10.3 kg (23 lbs)	R410A x 10.3 kg (23 lbs)	R410A x 11.8 kg (27 lbs)	R410A x 10.3 kg (23 lbs)	R410A x 11.8 kg (27 lbs)	R410A x 11.8 kg (27 lbs)	
	Net weight	252 (556)	252 (556)	318 (702)	252 (556)	318 (702)	318 (702)	
Heat exchanger		Salt-resistant cross fin & aluminium tube			Salt-resistant cross fin & aluminium tube			
Pipe between unit and distributor	Liquid pipe mm (in.)	12.7 (1/2) Brazed	12.7 (1/2) Brazed	15.88 (5/8) Brazed	12.7 (1/2) Brazed	15.88 (5/8) Brazed	15.88 (5/8) Brazed	
	Gas pipe mm (in.)	28.58 (1-1/8) Brazed	28.58 (1-1/8) Brazed	28.58 (1-1/8) Brazed	28.58 (1-1/8) Brazed	28.58 (1-1/8) Brazed	28.58 (1-1/8) Brazed	
Optional parts		Outdoor Twinning kit: CMY-Y300VBK3 Joint: CMY-Y102SS/LS-G2, CMY-Y202/302S-G2 Header: CMY-Y104/108/1010-G			Outdoor Twinning kit: CMY-Y300VBK3 Joint: CMY-Y102SS/LS-G2, CMY-Y202/302S-G2 Header: CMY-Y104/108/1010-G			

### Notes:

\*1,\*2 Nominal conditions

	Indoor	Outdoor	Pipe length	Level difference
Cooling	27°C DB/19°C WB (81°F DB/66°F WB)	35°C DB/24°C WB (95°F DB/75°F WB)	7.5m (24-9/16ft.)	0m (0ft.)
Heating	20°C DB/68°F DB)	7°C DB/6°C WB(45°F DB/43°F WB)	7.5m (24-9/16ft.)	0m (0ft.)

\*3 External static pressure option is available (30Pa, 60Pa / 3.1mmH<sub>2</sub>O, 6.1mmH<sub>2</sub>O).

\*Nominal condition \*1,\*2 are subject to JIS B8615-1.

\*Due to continuing improvement, above specification may be subject to change without notice.



# OUTDOOR UNIT Y Series - High COP PUHY-EP YSLM-A (-BS)



## ► Specifications

Model			PUHY-EP1250YSLM-A (-BS)			PUHY-EP1300YSLM-A (-BS)		
Power source			3-phase 4-wire 380-400-415 V 50/60 Hz			3-phase 4-wire 380-400-415 V 50/60 Hz		
Cooling capacity (Nominal)	*1	kW	140.0			146.0		
	*1	BTU / h	477,700			498,200		
		Power input kW	45.90			46.94		
		Current input A	77.4-73.6-70.9			79.2-75.2-72.5		
		EER kW / kW	3.05			3.11		
Temp. range of cooling	Indoor	W.B.	15.0~24.0°C (59~75°F)			15.0~24.0°C (59~75°F)		
	Outdoor	D.B.	-5.0~52.0°C (23~126°F)			-5.0~52.0°C (23~126°F)		
Heating capacity (Nominal)	*2	kW	156.5			163.0		
	*2	BTU / h	534,000			556,200		
		Power input kW	49.36			50.62		
		Current input A	83.3-79.1-76.2			85.4-81.1-78.2		
		COP kW / kW	3.17			3.22		
Temp. range of heating	Indoor	D.B.	15.0~27.0°C (59~81°F)			15.0~27.0°C (59~81°F)		
	Outdoor	W.B.	-20.0~15.5°C (-4~60°F)			-20.0~15.5°C (-4~60°F)		
Indoor unit connectable	Total capacity		50~130% of outdoor unit capacity			50~130% of outdoor unit capacity		
	Model / Quantity		P15~P250/3~50			P15~P250/3~50		
Sound pressure level (measured in anechoic room)		dB <A>	67.5			68		
Sound power level (measured in anechoic room)		dB <A>	88			88		
Refrigerant piping diameter	Liquid pipe	mm (in.)	19.05 (3/4) Brazed			19.05 (3/4) Brazed		
	Gas pipe	mm (in.)	41.28 (1-5/8) Brazed			41.28 (1-5/8) Brazed		
<b>Set Model</b>								
Model			PUHY-EP350YLM-A (-BS)	PUHY-EP450YLM-A (-BS)	PUHY-EP450YLM-A (-BS)	PUHY-EP400YLM-A (-BS)	PUHY-EP450YLM-A (-BS)	PUHY-EP450YLM-A (-BS)
FAN	Type x Quantity		Propeller fan x 1	Propeller fan x 2	Propeller fan x 2	Propeller fan x 2	Propeller fan x 2	Propeller fan x 2
	Air flow rate	m <sup>3</sup> /min	200	370	370	320	370	370
		L/s	3,333	6,167	6,167	5,333	6,167	6,167
		cfm	7,062	13,065	13,065	11,299	13,065	13,065
	Driving mechanism		Inverter-control, Direct-driven by motor			Inverter-control, Direct-driven by motor		
	Motor output	kW	0.92 x 1	0.92 x 2	0.92 x 2	0.92 x 2	0.92 x 2	0.92 x 2
*3	External static press.	0 Pa (0 mmH <sub>2</sub> O)	0 Pa (0 mmH <sub>2</sub> O)	0 Pa (0 mmH <sub>2</sub> O)	0 Pa (0 mmH <sub>2</sub> O)	0 Pa (0 mmH <sub>2</sub> O)	0 Pa (0 mmH <sub>2</sub> O)	
Compressor	Type x Quantity		Inverter scroll hermetic compressor			Inverter scroll hermetic compressor		
	Starting method		Inverter	Inverter	Inverter	Inverter	Inverter	Inverter
	Motor output	kW	10.5	12.4	12.4	10.9	12.4	12.4
	Case heater	kW	—	—	—	—	—	—
External finish		Pre-coated galvanized steel sheets (+powder coating for -BS type) <MUNSELL 5Y 8/1 or similar>			Pre-coated galvanized steel sheets (+powder coating for -BS type) <MUNSELL 5Y 8/1 or similar>			
External dimension HxWxD		mm	1,710 (1,650 without legs) x 1,220 x 740	1,710 (1,650 without legs) x 1,750 x 740	1,710 (1,650 without legs) x 1,750 x 740	1,710 (1,650 without legs) x 1,750 x 740	1,710 (1,650 without legs) x 1,750 x 740	1,710 (1,650 without legs) x 1,750 x 740
		in.	67-3/8 (65 without legs) x 48-1/16 x 29-3/16	67-3/8 (65 without legs) x 68-15/16 x 29-3/16	67-3/8 (65 without legs) x 68-15/16 x 29-3/16	67-3/8 (65 without legs) x 68-15/16 x 29-3/16	67-3/8 (65 without legs) x 68-15/16 x 29-3/16	67-3/8 (65 without legs) x 68-15/16 x 29-3/16
Protection devices	High pressure protection		High pressure sensor, High pressure switch at 4.15 MPa (601 psi)			High pressure sensor, High pressure switch at 4.15 MPa (601 psi)		
	Inverter circuit (COMP/FAN)		Over-heat protection, Over-current protection			Over-heat protection, Over-current protection		
	Compressor		Over-heat protection	Over-heat protection	Over-heat protection	Over-heat protection	Over-heat protection	Over-heat protection
Fan motor		Over-current protection	Over-current protection	Over-current protection	Over-current protection	Over-current protection	Over-current protection	
Refrigerant	Type x original charge	R410A x 10.3 kg (23 lbs)	R410A x 11.8 kg (27 lbs)	R410A x 11.8 kg (27 lbs)	R410A x 11.8 kg (27 lbs)	R410A x 11.8 kg (27 lbs)	R410A x 11.8 kg (27 lbs)	
Net weight	kg (lbs)	252 (556)	318 (702)	318 (702)	318 (702)	318 (702)	318 (702)	
Heat exchanger		Salt-resistant cross fin & aluminium tube			Salt-resistant cross fin & aluminium tube			
Pipe between unit and distributor	Liquid pipe	mm (in.)	12.7 (1/2) Brazed	15.88 (5/8) Brazed	15.88 (5/8) Brazed	15.88 (5/8) Brazed	15.88 (5/8) Brazed	
	Gas pipe	mm (in.)	28.58 (1-1/8) Brazed	28.58 (1-1/8) Brazed	28.58 (1-1/8) Brazed	28.58 (1-1/8) Brazed	28.58 (1-1/8) Brazed	
Optional parts		Outdoor Twinning kit: CMY-Y300VBK3 Joint: CMY-Y102SS/LS-G2, CMY-Y202/302S-G2 Header: CMY-Y104/108/1010-G			Outdoor Twinning kit: CMY-Y300VBK3 Joint: CMY-Y102SS/LS-G2, CMY-Y202/302S-G2 Header: CMY-Y104/108/1010-G			

### Notes:

\*1,\*2 Nominal conditions

	Indoor	Outdoor	Pipe length	Level difference
Cooling	27°C DB/19°C WB (81°F DB/66°F WB)	35°C DB/24°C WB (95°F DB/75°F WB)	7.5m (24-9/16ft.)	0m (0ft.)
Heating	20°C DB(68°F DB)	7°C DB/6°C WB(45°F DB/43°F WB)	7.5m (24-9/16ft.)	0m (0ft.)

\*3 External static pressure option is available (30Pa, 60Pa / 3.1mmH<sub>2</sub>O, 6.1mmH<sub>2</sub>O).

\*Nominal condition \*1,\*2 are subject to JIS B8615-1.

\*Due to continuing improvement, above specification may be subject to change without notice.



Outdoor Unit

# OUTDOOR UNIT Y Series - High COP PUHY-EP YSLM-A(-BS)



## ► Specifications

Model		PUHY-EP1350YSLM-A (-BS)			
Power source		3-phase 4-wire 380-400-415 V 50/60 Hz			
Cooling capacity (Nominal)	*1 kW	150.0			
	*1 BTU / h	511,800			
	Power input kW	50.00			
	Current input A	84.4-80.1-77.2			
	EER kW / kW	3.00			
Temp. range of cooling	Indoor W.B.	15.0~24.0°C (59~75°F)			
	Outdoor D.B.	-5.0~52.0°C (23~126°F)			
Heating capacity (Nominal)	*2 kW	168.0			
	*2 BTU / h	573,200			
	Power input kW	54.36			
	Current input A	91.7-87.1-84.0			
	COP kW / kW	3.09			
Temp. range of heating	Indoor D.B.	15.0~27.0°C (59~81°F)			
	Outdoor W.B.	-20.0~15.5°C (-4~60°F)			
Indoor unit connectable	Total capacity	50~130% of outdoor unit capacity			
	Model / Quantity	P15~P250/3~50			
Sound pressure level (measured in anechoic room)	dB <A>	68			
Sound power level (measured in anechoic room)	dB <A>	88			
Refrigerant piping diameter	Liquid pipe mm (in.)	19.05 (3/4) Brazed			
	Gas pipe mm (in.)	41.28 (1-5/8) Brazed			
<b>Set Model</b>					
Model		PUHY-EP450YLM-A (-BS)	PUHY-EP450YLM-A (-BS)	PUHY-EP450YLM-A (-BS)	
FAN	Type x Quantity	Propeller fan x 2			
	Air flow rate	m <sup>3</sup> /min	370	370	370
		L/s	6,167	6,167	6,167
		cfm	13,065	13,065	13,065
	Driving mechanism	Inverter-control, Direct-driven by motor			
	Motor output kW	0.92 x 2	0.92 x 2	0.92 x 2	
*3 External static press.	0 Pa (0 mmH <sub>2</sub> O)	0 Pa (0 mmH <sub>2</sub> O)	0 Pa (0 mmH <sub>2</sub> O)		
Compressor	Type x Quantity	Inverter scroll hermetic compressor			
	Starting method	Inverter	Inverter	Inverter	
	Motor output kW	12.4	12.4	12.4	
	Case heater kW	—	—	—	
External finish		Pre-coated galvanized steel sheets (+powder coating for -BS type) <MUNSELL 5Y 8/1 or similar>			
External dimension HxWxD	mm	1,710 (1,650 without legs) x 1,750 x 740	1,710 (1,650 without legs) x 1,750 x 740	1,710 (1,650 without legs) x 1,750 x 740	
	in.	67-3/8 (65 without legs) x 68-15/16 x 29-3/16	67-3/8 (65 without legs) x 68-15/16 x 29-3/16	67-3/8 (65 without legs) x 68-15/16 x 29-3/16	
Protection devices	High pressure protection	High pressure sensor, High pressure switch at 4.15 MPa (601 psi)			
	Inverter circuit (COMP/FAN)	Over-heat protection, Over-current protection			
	Compressor	Over-heat protection	Over-heat protection	Over-heat protection	
Refrigerant	Type x original charge	R410A x 11.8 kg (27 lbs)	R410A x 11.8 kg (27 lbs)	R410A x 11.8 kg (27 lbs)	
	Net weight kg (lbs)	318 (702)	318 (702)	318 (702)	
Heat exchanger		Salt-resistant cross fin & aluminium tube			
Pipe between unit and distributor	Liquid pipe mm (in.)	15.88 (5/8) Brazed	15.88 (5/8) Brazed	15.88 (5/8) Brazed	
	Gas pipe mm (in.)	28.58 (1-1/8) Brazed	28.58 (1-1/8) Brazed	28.58 (1-1/8) Brazed	
Optional parts		Outdoor Twinning kit: CMY-Y300VBK3 Joint: CMY-Y102SS/LS-G2, CMY-Y202/302S-G2 Header: CMY-Y104/108/1010-G			

### Notes:

\*1,\*2 Nominal conditions

	Indoor	Outdoor	Pipe length	Level difference
Cooling	27°C DB/19°C WB (81°F DB/66°F WB)	35°C DB/24°C WB (95°F DB/75°F WB)	7.5m (24-9/16ft.)	0m (0ft.)
Heating	20°C DB/68°F DB)	7°C DB/6°C WB(45°F DB/43°F WB)	7.5m (24-9/16ft.)	0m (0ft.)

\*3 External static pressure option is available (30Pa, 60Pa / 3.1mmH<sub>2</sub>O, 6.1mmH<sub>2</sub>O).

\*Nominal condition \*1,\*2 are subject to JIS B8615-1.

\*Due to continuing improvement, above specification may be subject to change without notice.



# HEAT SOURCE UNIT WY (Heat Pump) Series PQHY-P YHM-A



## ► Specifications

Model	PQHY-P200YHM-A		PQHY-P250YHM-A		PQHY-P300YHM-A	
Power source	3-phase 4-wire 380-400-415V 50/60Hz		3-phase 4-wire 380-400-415V 50/60Hz		3-phase 4-wire 380-400-415V 50/60Hz	
Cooling capacity (Nominal)	*1	kW	22.4		28.0	
	*1	BTU / h	76,400		95,500	
		Power input kW	3.92		5.45	
		Current input A	6.6-6.2-6.0		9.2-8.7-8.4	
		EER	5.71		5.13	
Temp. range of cooling	Indoor	W.B.	15.0~24.0°C(59~75°F)		15.0~24.0°C(59~75°F)	
	Circulating water	°C	10.0~45.0°C(50~113°F)		10.0~45.0°C(50~113°F)	
Heating capacity (Nominal)	*2	kW	25.0		31.5	
	*2	BTU / h	85,300		107,500	
		Power input kW	4.12		5.80	
		Current input A	6.9-6.6-6.3		9.7-9.3-8.9	
		COP	6.06		5.43	
Temp. range of heating	Indoor	D.B.	15.0~27.0°C(59~81°F)		15.0~27.0°C(59~81°F)	
	Circulating water	°C	10.0~45.0°C(50~113°F)		10.0~45.0°C(50~113°F)	
Indoor unit connectable	Total capacity	50~130 % of heat source unit capacity		50~130 % of heat source unit capacity		
	Model / Quantity	P15~P250 / 1~17		P15~P250 / 1~21		
Sound pressure level (measured in anechoic room)		dB <A>	47		49	
Refrigerant piping diameter [O.D.]	Liquid pipe	mm (in.)	9.52(3/8) Brazed		9.52(3/8) Brazed (12.7(1/2) Brazed, total length >= 90m)	
	Gas pipe	mm (in.)	19.05(3/4) Brazed		22.2(7/8) Brazed	
Circulating water	Water flow rate	m <sup>3</sup> / h	5.76		5.76	
		L/min	96		96	
		cfm	3.4		3.4	
	Pressure drop	kPa	17		17	
	Operating volume range	m <sup>3</sup> / h	4.5 ~ 7.2		4.5 ~ 7.2	
Compressor	Type x Quantity	Inverter scroll hermetic compressor		Inverter scroll hermetic compressor		
	Starting method	Inverter		Inverter		
	Motor output	kW	4.6		6.3	
	Case heater	kW	0.035(240 V)		0.035(240 V)	
External finish	Acrylic painted steel plate		Acrylic painted steel plate		Acrylic painted steel plate	
External dimension HxWxD	mm	1,160(1,100 without legs) x 880 x 550		1,160(1,100 without legs) x 880 x 550		
	in.	45-11/16(43-5/16 without legs) x 34-11/16 x 21-11/16		45-11/16(43-5/16 without legs) x 34-11/16 x 21-11/16		
Protection devices	High pressure protection	High pressure sensor, High pressure switch at 4.15MPa (601 psi)		High pressure sensor, High pressure switch at 4.15MPa (601 psi)		
	Inverter circuit (COMP.)	Over-heat protection, Over-current protection		Over-heat protection, Over-current protection		
Refrigerant	Type x original charge	R410A x 5.0kg (12lbs)		R410A x 5.0kg (12lbs)		
	Net weight	kg (lbs)	195(430)		195(430)	
Heat exchanger			plate type		plate type	
	Water volume in plate	L	5.0		5.0	
	Water pressure Max.	MPa	2.0		2.0	
Optional parts	Joint: CMY-Y102SS-G2 Header: CMY-Y104/108/1010-G		Joint: CMY-Y102SS-G2, CMY-Y102LS-G2 Header: CMY-Y104/108/1010-G		Joint: CMY-Y102SS-G2, CMY-Y102LS-G2 Header: CMY-Y104/108/1010-G	

### Notes:

\*1,\*2 Nominal conditions

	Indoor	Water temperature	Pipe length	Level difference
Cooling	27°C D.B./19°C W.B. (81°F D.B./66°F W.B.)	30°C (86°F)	7.5m (24-9/16ft.)	0m (0ft.)
Heating	20°C D.B. (68°F D.B.)	20°C (68°F)		

\*3 The ambient temperature of the heat source unit needs to be kept below 40°C D.B.

\*4 The ambient relative humidity of the heat source unit needs to be kept below 80%.

\*5 The heat source Unit should not be installed at outdoor.

\*6 Be sure to mount a strainer (more than 50 meshes) at the water inlet piping of the unit.

\*7 Be sure to provide interlocking for the unit operation and water circuit.

\*Nominal condition \*1,\*2 are subject to JIS B8615-1.

\*Due to continuing improvement, above specification may be subject to change without notice.



### Outdoor Unit



# HEAT SOURCE UNIT WY (Heat Pump) Series PQHY-P YSHM-A



## ► Specifications

Model		PQHY-P400YSHM-A		PQHY-P450YSHM-A		PQHY-P500YSHM-A		
Power source		3-phase 4-wire 380-400-415V 50/60Hz		3-phase 4-wire 380-400-415V 50/60Hz		3-phase 4-wire 380-400-415V 50/60Hz		
Cooling capacity (Nominal)	*1 kW	45.0		50.0		56.0		
	*1 BTU / h	153,500		170,600		191,100		
	Power input kW	8.25		9.84		11.45		
	Current input A	13.9-13.2-12.7		16.6-15.7-15.2		19.3-18.3-17.6		
Temp. range of cooling	W.B.	15.0~24.0°C(59~75°F)		15.0~24.0°C(59~75°F)		15.0~24.0°C(59~75°F)		
	Circulating water °C	10.0~45.0°C(50~113°F)		10.0~45.0°C(50~113°F)		10.0~45.0°C(50~113°F)		
Heating capacity (Nominal)	*2 kW	50.0		56.0		63.0		
	*2 BTU / h	170,600		191,100		215,000		
	Power input kW	8.65		10.42		12.06		
	Current input A	14.6-13.8-13.3		17.5-16.7-16.1		20.3-19.3-18.6		
Temp. range of heating	D.B.	15.0~27.0°C(59~81°F)		15.0~27.0°C(59~81°F)		15.0~27.0°C(59~81°F)		
	Circulating water °C	10.0~45.0°C(50~113°F)		10.0~45.0°C(50~113°F)		10.0~45.0°C(50~113°F)		
Indoor unit connectable	Total capacity	50~130 % of heat source unit capacity		50~130 % of heat source unit capacity		50~130 % of heat source unit capacity		
	Model / Quantity	P15~P250 / 1~34		P15~P250 / 1~39		P15~P250 / 1~43		
Sound pressure level (measured in anechoic room)	dB <A>	50		51		52		
Refrigerant piping diameter [O.D.]	Liquid pipe mm (in.)	12.7(1/2) Brazed		15.88(5/8) Brazed		15.88(5/8) Brazed		
	Gas pipe mm (in.)	28.58(1-1/8) Brazed		28.58(1-1/8) Brazed		28.58(1-1/8) Brazed		
Set Model								
Model		PQHY-P200YHM-A	PQHY-P200YHM-A	PQHY-P250YHM-A	PQHY-P200YHM-A	PQHY-P250YHM-A	PQHY-P250YHM-A	
Circulating water	Water flow rate	m <sup>3</sup> / h	5.76 + 5.76		5.76 + 5.76		5.76 + 5.76	
		L/min	96 + 96		96 + 96		96 + 96	
		cfm	3.4 + 3.4		3.4 + 3.4		3.4 + 3.4	
	Pressure drop	kPa	17	17	17	17	17	17
Operating volume range	m <sup>3</sup> / h	4.5 + 4.5 ~ 7.2 + 7.2		4.5 + 4.5 ~ 7.2 + 7.2		4.5 + 4.5 ~ 7.2 + 7.2		
Compressor	Type x Quantity	Inverter scroll hermetic compressor		Inverter scroll hermetic compressor		Inverter scroll hermetic compressor		
	Starting method	Inverter	Inverter	Inverter	Inverter	Inverter	Inverter	
	Motor output	kW	4.6	4.6	6.3	4.6	6.3	6.3
	Case heater	kW	0.035(240 V)	0.035(240 V)	0.035(240 V)	0.035(240 V)	0.035(240 V)	0.035(240 V)
External finish		Acrylic painted steel plate		Acrylic painted steel plate		Acrylic painted steel plate		
External dimension HxWxD	mm	1,160(1,100 without legs) x 880 x 550	1,160(1,100 without legs) x 880 x 550	1,160(1,100 without legs) x 880 x 550	1,160(1,100 without legs) x 880 x 550	1,160(1,100 without legs) x 880 x 550	1,160(1,100 without legs) x 880 x 550	
		in.	45-11/16(43-5/16 without legs) x 34-11/16 x 21-11/16	45-11/16(43-5/16 without legs) x 34-11/16 x 21-11/16	45-11/16(43-5/16 without legs) x 34-11/16 x 21-11/16	45-11/16(43-5/16 without legs) x 34-11/16 x 21-11/16	45-11/16(43-5/16 without legs) x 34-11/16 x 21-11/16	45-11/16(43-5/16 without legs) x 34-11/16 x 21-11/16
Protection devices	High pressure protection	High pressure sensor, High pressure switch at 4.15MPa (601 psi)		High pressure sensor, High pressure switch at 4.15MPa (601 psi)		High pressure sensor, High pressure switch at 4.15MPa (601 psi)		
	Inverter circuit (COMP.)	Over-heat protection, Over-current protection		Over-heat protection, Over-current protection		Over-heat protection, Over-current protection		
	Compressor	Over-heat protection		Over-heat protection		Over-heat protection		
Refrigerant	Type x original charge	R410A x 5.0kg (12lbs)	R410A x 5.0kg (12lbs)	R410A x 5.0kg (12lbs)	R410A x 5.0kg (12lbs)	R410A x 5.0kg (12lbs)	R410A x 5.0kg (12lbs)	
Net weight	kg (lbs)	195(430)	195(430)	195(430)	195(430)	195(430)	195(430)	
Heat exchanger		plate type	plate type	plate type	plate type	plate type	plate type	
	Water volume in plate	L	5.0	5.0	5.0	5.0	5.0	
	Water pressure Max.	MPa	2.0	2.0	2.0	2.0	2.0	
Optional parts		Heat Source Twinning kit: CMY-Y100VBK2 Joint: CMY-Y102SS-G2, CMY-Y102LS-G2, CMY-Y202S-G2 Header: CMY-Y104/108/1010-G		Heat Source Twinning kit: CMY-Y100VBK2 Joint: CMY-Y102SS-G2, CMY-Y102LS-G2, CMY-Y202S-G2 Header: CMY-Y104/108/1010-G		Heat Source Twinning kit: CMY-Y100VBK2 Joint: CMY-Y102SS-G2, CMY-Y102LS-G2, CMY-Y202S-G2 Header: CMY-Y104/108/1010-G		

### Notes:

\*1, \*2 Nominal conditions

	Indoor	Water temperature	Pipe length	Level difference
Cooling	27°C D.B./19°C W.B. (81°F D.B./66°F W.B.)	30°C (86°F)	7.5m (24-9/16ft.)	0m (0ft.)
Heating	20°C D.B. (68°F D.B.)	20°C (68°F)		

\*3 The ambient temperature of the heat source unit needs to be kept below 40°C D.B.

\*4 The ambient relative humidity of the heat source unit needs to be kept below 80%.

\*5 The heat source Unit should not be installed at outdoor.

\*6 Be sure to mount a strainer (more than 50 meshes) at the water inlet piping of the unit.

\*7 Be sure to provide interlocking for the unit operation and water circuit.

\*Nominal condition \*1, \*2 are subject to JIS B8615-1.

\*Due to continuing improvement, above specification may be subject to change without notice.



# HEAT SOURCE UNIT WY (Heat Pump) Series PQHY-P YSHM-A



## ► Specifications

Model			PQHY-P550YSHM-A		PQHY-P600YSHM-A	
Power source			3-phase 4-wire 380-400-415V 50/60Hz		3-phase 4-wire 380-400-415V 50/60Hz	
Cooling capacity (Nominal)	*1	kW	63.0		69.0	
	*1	BTU / h	215,000		235,400	
		Power input kW	13.46		15.48	
		Current input A	22.7-21.5-20.8		26.1-24.8-23.9	
	EER	kW / kW	4.68		4.45	
Temp. range of cooling	Indoor	W.B.	15.0~24.0°C(59~75°F)		15.0~24.0°C(59~75°F)	
	Circulating water	°C	10.0~45.0°C(50~113°F)		10.0~45.0°C(50~113°F)	
Heating capacity (Nominal)	*2	kW	69.0		76.5	
	*2	BTU / h	235,400		261,000	
		Power input kW	14.65		17.12	
		Current input A	24.7-23.4-22.6		28.9-27.4-26.4	
	COP	kW / kW	4.70		4.46	
Temp. range of heating	Indoor	D.B.	15.0~27.0°C(59~81°F)		15.0~27.0°C(59~81°F)	
	Circulating water	°C	10.0~45.0°C(50~113°F)		10.0~45.0°C(50~113°F)	
Indoor unit connectable	Total capacity	50~130 % of heat source unit capacity		50~130 % of heat source unit capacity		
	Model / Quantity	P15~P250 / 2~47		P15~P250 / 2~50		
Sound pressure level (measured in anechoic room)		dB <A>	52.5		53	
Refrigerant piping diameter [O.D.]	Liquid pipe	mm (in.)	15.88(5/8) Brazed		15.88(5/8) Brazed	
	Gas pipe	mm (in.)	28.58(1-1/8) Brazed		28.58(1-1/8) Brazed	
Set Model						
Model			PQHY-P300YHM-A		PQHY-P250YHM-A	
Circulating water	Water flow rate	m <sup>3</sup> / h	5.76 + 5.76		5.76 + 5.76	
		L/min	96 + 96		96 + 96	
		cfm	3.4 + 3.4		3.4 + 3.4	
	Pressure drop	kPa	17		17	
Operating volume range	m <sup>3</sup> / h	4.5 + 4.5 ~ 7.2 + 7.2		4.5 + 4.5 ~ 7.2 + 7.2		
Compressor	Type x Quantity	Inverter scroll hermetic compressor		Inverter scroll hermetic compressor		
	Starting method	Inverter	Inverter	Inverter	Inverter	
	Motor output	kW	7.4		7.4	
	Case heater	kW	0.035(240 V)		0.035(240 V)	
External finish		Acrylic painted steel plate	Acrylic painted steel plate	Acrylic painted steel plate	Acrylic painted steel plate	
External dimension HxWxD	mm	1,160(1,100 without legs) x 880 x 550		1,160(1,100 without legs) x 880 x 550		
		45-11/16(43-5/16 without legs) x 34-11/16 x 21-11/16		45-11/16(43-5/16 without legs) x 34-11/16 x 21-11/16		
Protection devices	High pressure protection	High pressure sensor, High pressure switch at 4.15MPa (601 psi)		High pressure sensor, High pressure switch at 4.15MPa (601 psi)		
	Inverter circuit (COMP.)	Over-heat protection, Over-current protection		Over-heat protection, Over-current protection		
	Compressor	Over-heat protection		Over-heat protection		
Refrigerant	Type x original charge	R410A x 5.0kg (12lbs)	R410A x 5.0kg (12lbs)	R410A x 5.0kg (12lbs)	R410A x 5.0kg (12lbs)	
Net weight	kg (lbs)	195(430)		195(430)		
Heat exchanger			plate type		plate type	
	Water volume in plate	L	5.0		5.0	
	Water pressure Max.	MPa	2.0		2.0	
Optional parts			Heat Source Twinning kit: CMY-Y100VBK2 Joint: CMY-Y102SS-G2, CMY-Y102LS-G2, CMY-Y202S-G2, CMY-Y302S-G2 Header: CMY-Y104/108/1010-G		Heat Source Twinning kit: CMY-Y100VBK2 Joint: CMY-Y102SS-G2, CMY-Y102LS-G2, CMY-Y202S-G2, CMY-Y302S-G2 Header: CMY-Y104/108/1010-G	

### Notes:

\*1,\*2 Nominal conditions

	Indoor	Water temperature	Pipe length	Level difference
Cooling	27°C D.B./19°C W.B. (81°F D.B./66°F W.B.)	30°C (86°F)	7.5m (24-9/16ft.)	0m (0ft.)
Heating	20°C D.B. (68°F D.B.)	20°C (68°F)		

\*3 The ambient temperature of the heat source unit needs to be kept below 40°C D.B.

\*4 The ambient relative humidity of the heat source unit needs to be kept below 80%.

\*5 The heat source Unit should not be installed at outdoor.

\*6 Be sure to mount a strainer (more than 50 meshes) at the water inlet piping of the unit.

\*7 Be sure to provide interlocking for the unit operation and water circuit.

\*Nominal condition \*1,\*2 are subject to JIS B8615-1.

\*Due to continuing improvement, above specification may be subject to change without notice.



Outdoor Unit

# HEAT SOURCE UNIT WY (Heat Pump) Series PQHY-P YSHM-A



## ► Specifications

Model		PQHY-P650YSHM-A			PQHY-P700YSHM-A			
Power source		3-phase 4-wire 380-400-415V 50/60Hz			3-phase 4-wire 380-400-415V 50/60Hz			
Cooling capacity (Nominal)	*1 kW	73.0			80.0			
	*1 BTU / h	249,100			273,000			
	Power input kW	13.96			15.58			
	Current input A	23.5-22.3-21.5			26.3-24.9-24.0			
EER	kW / kW	5.22			5.13			
Temp. range of cooling	Indoor W.B.	15.0~24.0°C(59~75°F)			15.0~24.0°C(59~75°F)			
	Circulating water °C	10.0~45.0°C(50~113°F)			10.0~45.0°C(50~113°F)			
Heating capacity (Nominal)	*2 kW	81.5			88.0			
	*2 BTU / h	278,100			300,300			
	Power input kW	14.74			16.51			
	Current input A	24.8-23.6-22.7			27.8-26.4-25.5			
COP	kW / kW	5.52			5.33			
Temp. range of heating	Indoor D.B.	15.0~27.0°C(59~81°F)			15.0~27.0°C(59~81°F)			
	Circulating water °C	10.0~45.0°C(50~113°F)			10.0~45.0°C(50~113°F)			
Indoor unit connectable	Total capacity	50~130 % of heat source unit capacity			50~130 % of heat source unit capacity			
	Model / Quantity	P15~P250 / 2~50			P15~P250 / 2~50			
Sound pressure level (measured in anechoic room)	dB <A>	53			53.5			
Refrigerant piping diameter [O.D.]	Liquid pipe mm (in.)	19.05(3/4) Brazed			19.05(3/4) Brazed			
	Gas pipe mm (in.)	34.93(1-3/8) Brazed			34.93(1-3/8) Brazed			
Set Model								
Model		PQHY-P250YHM-A	PQHY-P200YHM-A	PQHY-P200YHM-A	PQHY-P250YHM-A	PQHY-P250YHM-A	PQHY-P200YHM-A	
Circulating water	Water flow rate	m <sup>3</sup> / h	5.76 + 5.76 + 5.76			5.76 + 5.76 + 5.76		
		L/min	96 + 96 + 96			96 + 96 + 96		
		cfm	3.4 + 3.4 + 3.4			3.4 + 3.4 + 3.4		
	Pressure drop	kPa	17	17	17	17	17	17
Operating volume range	m <sup>3</sup> / h	4.5 + 4.5 + 4.5 ~ 7.2 + 7.2 + 7.2			4.5 + 4.5 + 4.5 ~ 7.2 + 7.2 + 7.2			
Compressor	Type x Quantity	Inverter scroll hermetic compressor			Inverter scroll hermetic compressor			
	Starting method	Inverter	Inverter	Inverter	Inverter	Inverter	Inverter	
	Motor output	kW	6.3	4.6	4.6	6.3	6.3	4.6
	Case heater	kW	0.035(240 V)	0.035(240 V)	0.035(240 V)	0.035(240 V)	0.035(240 V)	0.035(240 V)
External finish		Acrylic painted steel plate			Acrylic painted steel plate			
External dimension HxWxD	mm	1,160(1,100 without legs) x 880 x 550	1,160(1,100 without legs) x 880 x 550	1,160(1,100 without legs) x 880 x 550	1,160(1,100 without legs) x 880 x 550	1,160(1,100 without legs) x 880 x 550	1,160(1,100 without legs) x 880 x 550	
		in.	45-11/16(43-5/16 without legs) x 34-11/16 x 21-11/16	45-11/16(43-5/16 without legs) x 34-11/16 x 21-11/16	45-11/16(43-5/16 without legs) x 34-11/16 x 21-11/16	45-11/16(43-5/16 without legs) x 34-11/16 x 21-11/16	45-11/16(43-5/16 without legs) x 34-11/16 x 21-11/16	45-11/16(43-5/16 without legs) x 34-11/16 x 21-11/16
Protection devices	High pressure protection	High pressure sensor, High pressure switch at 4.15MPa (601 psi)			High pressure sensor, High pressure switch at 4.15MPa (601 psi)			
	Inverter circuit (COMP.)	Over-heat protection, Over-current protection			Over-heat protection, Over-current protection			
	Compressor	Over-heat protection			Over-heat protection			
Refrigerant	Type x original charge	R410A x 5.0kg (12lbs)	R410A x 5.0kg (12lbs)	R410A x 5.0kg (12lbs)	R410A x 5.0kg (12lbs)	R410A x 5.0kg (12lbs)	R410A x 5.0kg (12lbs)	
Net weight	kg (lbs)	195(430)	195(430)	195(430)	195(430)	195(430)	195(430)	
Heat exchanger		plate type	plate type	plate type	plate type	plate type	plate type	
	Water volume in plate	L	5.0	5.0	5.0	5.0	5.0	
	Water pressure Max.	MPa	2.0	2.0	2.0	2.0	2.0	
Optional parts		Heat Source Twinning kit: CMY-Y300VBK2 Joint: CMY-Y102SS-G2,CMY-Y102LS-G2,CMY-Y202S-G2,CMY-Y302S-G2 Header: CMY-Y104/108/1010-G			Heat Source Twinning kit: CMY-Y300VBK2 Joint: CMY-Y102SS-G2,CMY-Y102LS-G2,CMY-Y202S-G2,CMY-Y302S-G2 Header: CMY-Y104/108/1010-G			

### Notes:

\*1,\*2 Nominal conditions

	Indoor	Water temperature	Pipe length	Level difference
Cooling	27°C D.B./19°C W.B. (81°F D.B./66°F W.B.)	30°C (86°F)	7.5m (24-9/16ft.)	0m (0ft.)
Heating	20°C D.B. (68°F D.B.)	20°C (68°F)		

\*3 The ambient temperature of the heat source unit needs to be kept below 40°C D.B.

\*4 The ambient relative humidity of the heat source unit needs to be kept below 80%.

\*5 The heat source Unit should not be installed at outdoor.

\*6 Be sure to mount a strainer (more than 50 meshes) at the water inlet piping of the unit.

\*7 Be sure to provide interlocking for the unit operation and water circuit.

\*Nominal condition \*1,\*2 are subject to JIS B8615-1.

\*Due to continuing improvement, above specification may be subject to change without notice.



# HEAT SOURCE UNIT WY (Heat Pump) Series PQHY-P YSHM-A



## ► Specifications

Model		PQHY-P750YSHM-A			PQHY-P800YSHM-A			
Power source		3-phase 4-wire 380-400-415V 50/60Hz			3-phase 4-wire 380-400-415V 50/60Hz			
Cooling capacity (Nominal)	*1 kW	85.0			90.0			
	*1 BTU / h	290,000			307,100			
	Power input kW	17.19			19.18			
	Current input A	29.0-27.5-26.5			32.3-30.7-29.6			
EER	kW / kW	4.94			4.69			
Temp. range of cooling	Indoor	W.B.	15.0~24.0°C(59~75°F)			15.0~24.0°C(59~75°F)		
	Circulating water	°C	10.0~45.0°C(50~113°F)			10.0~45.0°C(50~113°F)		
Heating capacity (Nominal)	*2 kW	95.0			100.0			
	*2 BTU / h	324,100			341,200			
	Power input kW	18.27			20.74			
	Current input A	30.8-29.3-28.2			35.0-33.2-32.0			
COP	kW / kW	5.19			4.82			
Temp. range of heating	Indoor	D.B.	15.0~27.0°C(59~81°F)			15.0~27.0°C(59~81°F)		
	Circulating water	°C	10.0~45.0°C(50~113°F)			10.0~45.0°C(50~113°F)		
Indoor unit connectable	Total capacity	50~130 % of heat source unit capacity			50~130 % of heat source unit capacity			
	Model / Quantity	P15~P250 / 2~50			P15~P250 / 2~50			
Sound pressure level (measured in anechoic room)	dB <A>	54			54			
Refrigerant piping	Liquid pipe	19.05(3/4) Brazed			19.05(3/4) Brazed			
diameter [O.D.]	Gas pipe	34.93(1-3/8) Brazed			34.93(1-3/8) Brazed			
Set Model								
Model		PQHY-P250YHM-A		PQHY-P300YHM-A		PQHY-P250YHM-A		
Circulating water	Water flow rate	m <sup>3</sup> / h	5.76 + 5.76 + 5.76		5.76 + 5.76 + 5.76			
		L/min	96 + 96 + 96		96 + 96 + 96			
		cfm	3.4 + 3.4 + 3.4		3.4 + 3.4 + 3.4			
	Pressure drop	kPa	17	17	17	17	17	
Operating volume range	m <sup>3</sup> / h	4.5 + 4.5 + 4.5 ~ 7.2 + 7.2 + 7.2			4.5 + 4.5 + 4.5 ~ 7.2 + 7.2 + 7.2			
Compressor	Type x Quantity	Inverter scroll hermetic compressor			Inverter scroll hermetic compressor			
	Starting method	Inverter	Inverter	Inverter	Inverter	Inverter	Inverter	
	Motor output	kW	6.3	6.3	6.3	7.4	6.3	6.3
	Case heater	kW	0.035(240 V)	0.035(240 V)	0.035(240 V)	0.035(240 V)	0.035(240 V)	0.035(240 V)
External finish	Acrylic painted steel plate			Acrylic painted steel plate				
External dimension HxWxD	mm	1,160(1,100 without legs) x 880 x 550	1,160(1,100 without legs) x 880 x 550	1,160(1,100 without legs) x 880 x 550	1,160(1,100 without legs) x 880 x 550	1,160(1,100 without legs) x 880 x 550	1,160(1,100 without legs) x 880 x 550	
		in.	45-11/16(43-5/16 without legs) x 34-11/16 x 21-11/16	45-11/16(43-5/16 without legs) x 34-11/16 x 21-11/16	45-11/16(43-5/16 without legs) x 34-11/16 x 21-11/16	45-11/16(43-5/16 without legs) x 34-11/16 x 21-11/16	45-11/16(43-5/16 without legs) x 34-11/16 x 21-11/16	45-11/16(43-5/16 without legs) x 34-11/16 x 21-11/16
Protection devices	High pressure protection	High pressure sensor, High pressure switch at 4.15MPa (601 psi)			High pressure sensor, High pressure switch at 4.15MPa (601 psi)			
	Inverter circuit (COMP.)	Over-heat protection, Over-current protection			Over-heat protection, Over-current protection			
	Compressor	Over-heat protection			Over-heat protection			
Refrigerant	Type x original charge	R410A x 5.0kg (12lbs)	R410A x 5.0kg (12lbs)	R410A x 5.0kg (12lbs)	R410A x 5.0kg (12lbs)	R410A x 5.0kg (12lbs)	R410A x 5.0kg (12lbs)	
Net weight	kg (lbs)	195(430)	195(430)	195(430)	195(430)	195(430)	195(430)	
Heat exchanger			plate type	plate type	plate type	plate type	plate type	
	Water volume in plate	L	5.0	5.0	5.0	5.0	5.0	
	Water pressure Max.	MPa	2.0	2.0	2.0	2.0	2.0	
Optional parts	Heat Source Twinning kit: CMY-Y300VBK2 Joint: CMY-Y102SS-G2,CMY-Y102LS-G2,CMY-Y202S-G2,CMY-Y302S-G2 Header: CMY-Y104/108/1010-G			Heat Source Twinning kit: CMY-Y300VBK2 Joint: CMY-Y102SS-G2,CMY-Y102LS-G2,CMY-Y202S-G2,CMY-Y302S-G2 Header: CMY-Y104/108/1010-G				

### Notes:

\*1,\*2 Nominal conditions

	Indoor	Water temperature	Pipe length	Level difference
Cooling	27°C D.B./19°C W.B. (81°F D.B./66°F W.B.)	30°C (86°F)	7.5m (24-9/16ft.)	0m (0ft.)
Heating	20°C D.B. (68°F D.B.)	20°C (68°F)		

\*3 The ambient temperature of the heat source unit needs to be kept below 40°C D.B.

\*4 The ambient relative humidity of the heat source unit needs to be kept below 80%.

\*5 The heat source Unit should not be installed at outdoor.

\*6 Be sure to mount a strainer (more than 50 meshes) at the water inlet piping of the unit.

\*7 Be sure to provide interlocking for the unit operation and water circuit.

\*Nominal condition \*1,\*2 are subject to JIS B8615-1.

\*Due to continuing improvement, above specification may be subject to change without notice.



### Outdoor Unit

# HEAT SOURCE UNIT WY (Heat Pump) Series PQHY-P YSHM-A



## ► Specifications

Model		PQHY-P850YSHM-A		PQHY-P900YSHM-A		
Power source		3-phase 4-wire 380-400-415V 50/60Hz		3-phase 4-wire 380-400-415V 50/60Hz		
Cooling capacity (Nominal)	*1 kW	96.0		101.0		
	*1 BTU / h	327,600		344,600		
	Power input kW	21.20		23.22		
	Current input A	35.7-33.9-32.7		39.1-37.2-35.8		
EER	kW / kW	4.52		4.34		
Temp. range of cooling	Indoor	W.B.	15.0~24.0°C(59~75°F)		15.0~24.0°C(59~75°F)	
	Circulating water	°C	10.0~45.0°C(50~113°F)		10.0~45.0°C(50~113°F)	
Heating capacity (Nominal)	*2 kW	108.0		113.0		
	*2 BTU / h	368,500		385,600		
	Power input kW	23.21		25.67		
	Current input A	39.1-37.2-35.8		43.3-41.1-39.6		
COP	kW / kW	4.65		4.40		
Temp. range of heating	Indoor	D.B.	15.0~27.0°C(59~81°F)		15.0~27.0°C(59~81°F)	
	Circulating water	°C	10.0~45.0°C(50~113°F)		10.0~45.0°C(50~113°F)	
Indoor unit connectable	Total capacity	50~130 % of heat source unit capacity		50~130 % of heat source unit capacity		
	Model / Quantity	P15~P250 / 2~50		P15~P250 / 2~50		
Sound pressure level (measured in anechoic room)	dB <A>	54.5		55		
Refrigerant piping diameter [O.D.]	Liquid pipe mm (in.)	19.05(3/4) Brazed		19.05(3/4) Brazed		
	Gas pipe mm (in.)	41.28(1-5/8) Brazed		41.28(1-5/8) Brazed		

Set Model

Model		PQHY-P300YHM-A			PQHY-P300YHM-A			
Circulating water	Water flow rate	m <sup>3</sup> / h	5.76 + 5.76 + 5.76			5.76 + 5.76 + 5.76		
		L/min	96 + 96 + 96			96 + 96 + 96		
		cfm	3.4 + 3.4 + 3.4			3.4 + 3.4 + 3.4		
	Pressure drop	kPa	17	17	17	17	17	17
Operating volume range	m <sup>3</sup> / h	4.5 + 4.5 + 4.5 ~ 7.2 + 7.2 + 7.2			4.5 + 4.5 + 4.5 ~ 7.2 + 7.2 + 7.2			
Compressor	Type x Quantity	Inverter scroll hermetic compressor			Inverter scroll hermetic compressor			
	Starting method	Inverter	Inverter	Inverter	Inverter	Inverter	Inverter	
	Motor output	kW	7.4	7.4	6.3	7.4	7.4	7.4
	Case heater	kW	0.035(240 V)	0.035(240 V)	0.035(240 V)	0.035(240 V)	0.035(240 V)	0.035(240 V)
External finish		Acrylic painted steel plate			Acrylic painted steel plate			
External dimension HxWxD	mm	1,160(1,100 without legs) x 880 x 550	1,160(1,100 without legs) x 880 x 550	1,160(1,100 without legs) x 880 x 550	1,160(1,100 without legs) x 880 x 550	1,160(1,100 without legs) x 880 x 550	1,160(1,100 without legs) x 880 x 550	
		in.	45-11/16(43-5/16 without legs) x 34-11/16 x 21-11/16	45-11/16(43-5/16 without legs) x 34-11/16 x 21-11/16	45-11/16(43-5/16 without legs) x 34-11/16 x 21-11/16	45-11/16(43-5/16 without legs) x 34-11/16 x 21-11/16	45-11/16(43-5/16 without legs) x 34-11/16 x 21-11/16	45-11/16(43-5/16 without legs) x 34-11/16 x 21-11/16
Protection devices	High pressure protection	High pressure sensor, High pressure switch at 4.15MPa (601 psi)			High pressure sensor, High pressure switch at 4.15MPa (601 psi)			
	Inverter circuit (COMP.)	Over-heat protection, Over-current protection			Over-heat protection, Over-current protection			
	Compressor	Over-heat protection			Over-heat protection			
Refrigerant	Type x original charge	R410A x 5.0kg (12lbs)	R410A x 5.0kg (12lbs)	R410A x 5.0kg (12lbs)	R410A x 5.0kg (12lbs)	R410A x 5.0kg (12lbs)	R410A x 5.0kg (12lbs)	
Net weight	kg (lbs)	195(430)	195(430)	195(430)	195(430)	195(430)	195(430)	
Heat exchanger			plate type	plate type	plate type	plate type	plate type	
	Water volume in plate	L	5.0	5.0	5.0	5.0	5.0	
	Water pressure Max.	MPa	2.0	2.0	2.0	2.0	2.0	
Optional parts	Heat Source Twinning kit: CMY-Y300VBK2 Joint: CMY-Y102SS-G2,CMY-Y102LS-G2,CMY-Y202S-G2,CMY-Y302S-G2 Header: CMY-Y104/108/1010-G			Heat Source Twinning kit: CMY-Y300VBK2 Joint: CMY-Y102SS-G2,CMY-Y102LS-G2,CMY-Y202S-G2,CMY-Y302S-G2 Header: CMY-Y104/108/1010-G				

### Notes:

\*1,\*2 Nominal conditions

	Indoor	Water temperature	Pipe length	Level difference
Cooling	27°C D.B./19°C W.B. (81°F D.B./66°F W.B.)	30°C (86°F)	7.5m (24-9/16ft.)	0m (0ft.)
Heating	20°C D.B. (68°F D.B.)	20°C (68°F)		

\*3 The ambient temperature of the heat source unit needs to be kept below 40°C D.B.

\*4 The ambient relative humidity of the heat source unit needs to be kept below 80%.

\*5 The heat source Unit should not be installed at outdoor.

\*6 Be sure to mount a strainer (more than 50 meshes) at the water inlet piping of the unit.

\*7 Be sure to provide interlocking for the unit operation and water circuit.

\*Nominal condition \*1,\*2 are subject to JIS B8615-1.

\*Due to continuing improvement, above specification may be subject to change without notice.



# OUTDOOR UNIT

## R2 Series

### PURY-P YLM-A(-BS)



## ► Specifications

Model	PURY-P200YLM-A (-BS)		PURY-P250YLM-A (-BS)	
Power source	3-phase 4-wire 380-400-415 V 50/60 Hz		3-phase 4-wire 380-400-415 V 50/60 Hz	
Cooling capacity (Nominal)	*1	kW	22.4	28.0
	*1	BTU / h	76,400	95,500
		Power input kW	5.95	7.93
		Current input A	10.0-9.5-9.1	13.3-12.7-12.2
		EER kW / kW	3.76	3.53
Temp. range of cooling	*3	Indoor W.B.	15.0~24.0°C (59~75°F)	15.0~24.0°C (59~75°F)
		Outdoor D.B.	-5.0~46.0°C (23~115°F)	-5.0~46.0°C (23~115°F)
Heating capacity (Nominal)	*2	kW	25.0	31.5
	*2	BTU / h	85,300	107,500
		Power input kW	6.54	8.65
		Current input A	11.0-10.4-10.1	14.6-13.8-13.3
		COP kW / kW	3.82	3.64
Temp. range of heating	*3	Indoor D.B.	15.0~27.0°C (59~81°F)	15.0~27.0°C (59~81°F)
		Outdoor W.B.	-20.0~15.5°C (-4~60°F)	-20.0~15.5°C (-4~60°F)
Indoor unit connectable	Total capacity		50~150%	50~150% of outdoor unit capacity
	Model / Quantity		P15~P250/1~20	P15~P250/1~25
Sound pressure level (measured in anechoic room)	dB <A>		59	60
Sound power level (measured in anechoic room)	dB <A>		82.5	83.5
Refrigerant piping diameter	High pressure	mm (in.)	15.88 (5/8) Brazed	19.05 (3/4) Brazed
	Low pressure	mm (in.)	19.05 (3/4) Brazed	22.2 (7/8) Brazed
FAN	Type x Quantity		Propeller fan x 1	Propeller fan x 1
	Air flow rate	m <sup>3</sup> /min	185	185
		L/s	3,083	3,083
		cfm	6,532	6,532
	Driving mechanism		Inverter-control, Direct-driven by motor	Inverter-control, Direct-driven by motor
	Motor output		0.92 x 1	0.92 x 1
*4 External static press.		0 Pa (0 mmH <sub>2</sub> O)	0 Pa (0 mmH <sub>2</sub> O)	
Compressor	Type x Quantity		Inverter scroll hermetic compressor	Inverter scroll hermetic compressor
	Starting method		Inverter	Inverter
	Motor output kW		5.6	6.9
	Case heater kW		-	-
External finish		Pre-coated galvanized steel sheets (+powder coating for -BS type) <MUNSELL 5Y 8/1 or similar>		
External dimension HxWxD	mm		1,710 (1,650 without legs) x 920 x 740	1,710 (1,650 without legs) x 920 x 740
	in.		67-3/8 (65 without legs) x 36-1/4 x 29-3/16	67-3/8 (65 without legs) x 36-1/4 x 29-3/16
Protection devices	High pressure protection		High pressure sensor, High pressure switch at 4.15 MPa (601 psi)	High pressure sensor, High pressure switch at 4.15 MPa (601 psi)
	Inverter circuit (COMP./FAN)		Over-heat protection, Over-current protection	Over-heat protection, Over-current protection
	Compressor		Over-heat protection	Over-heat protection
	Fan motor		Over-current protection	Over-current protection
Refrigerant	Type x original charge		R410A x 9.5 kg (21 lbs)	R410A x 9.5 kg (21 lbs)
Net weight	kg (lbs)		205 (452)	205 (452)
Heat exchanger		Salt-resistant cross fin & copper tube		Salt-resistant cross fin & copper tube
Optional parts		Joint: CMY-Y102SS-G2,CMY-Y102LS-G2,CMY-R160-J1 BC controller: CMB-P104,105,106,108,1010,1013,1016V-G1 Main BC controller: CMB-P108,1010,1013,1016V-GA1 Sub BC controller: CMB-P104,108V-GB1,CMB-P1016V-HB1		Joint: CMY-Y102SS-G2,CMY-Y102LS-G2,CMY-R160-J1 BC controller: CMB-P104,105,106,108,1010,1013,1016V-G1 Main BC controller: CMB-P108,1010,1013,1016V-GA1 Sub BC controller: CMB-P104,108V-GB1,CMB-P1016V-HB1

### Notes:

\*1,\*2 Nominal conditions

	Indoor	Outdoor	Pipe length	Level difference
Cooling	27°C DB/19°C WB (81°F DB/66°F WB)	35°C DB/24°C WB (95°F DB/75°F WB)	7.5m (24-9/16ft.)	0m (0ft.)
Heating	20°C DB/68°F DB)	7°C DB/6°C WB(45°F DB/43°F WB)	7.5m (24-9/16ft.)	0m (0ft.)

\*3 -5°C DB (23°F DB) / -6°C WB (21°F WB) to 21°C DB (70°F DB) / 15.5°C WB (60°F WB) with cooling/heating mixed operation.

\*4 External static pressure option is available (30Pa, 60Pa / 3.1mmH<sub>2</sub>O, 6.1mmH<sub>2</sub>O).

\*Nominal condition \*1,\*2 are subject to JIS B8615-1.

\*Due to continuing improvement, above specification may be subject to change without notice.



# OUTDOOR UNIT

## R2 Series

### PURY-P YLM-A(-BS)



## ► Specifications

Model		PURY-P300YLM-A (-BS)	PURY-P350YLM-A (-BS)	
Power source		3-phase 4-wire 380-400-415 V 50/60 Hz		
Cooling capacity (Nominal)	*1 kW	33.5	40.0	
	*1 BTU / h	114,300	136,500	
	Power input kW	9.82	12.69	
	Current input A	16.5-15.7-15.1	21.4-20.3-19.6	
	EER kW / kW	3.41	3.15	
Temp. range of cooling	*3 Indoor W.B.	15.0~24.0°C (59~75°F)	15.0~24.0°C (59~75°F)	
	Outdoor D.B.	-5.0~46.0°C (23~115°F)	-5.0~46.0°C (23~115°F)	
Heating capacity (Nominal)	*2 kW	37.5	45.0	
	*2 BTU / h	128,000	153,500	
	Power input kW	10.77	12.97	
	Current input A	18.1-17.2-16.6	21.8-20.8-20.0	
	COP kW / kW	3.48	3.46	
Temp. range of heating	*3 Indoor D.B.	15.0~27.0°C (59~81°F)	15.0~27.0°C (59~81°F)	
	Outdoor W.B.	-20.0~15.5°C (-4~60°F)	-20.0~15.5°C (-4~60°F)	
Indoor unit connectable	Total capacity	50~150% of outdoor unit capacity	50~150% of outdoor unit capacity	
	Model / Quantity	P15~P250/1~30	P15~P250/1~35	
Sound pressure level (measured in anechoic room)	dB <A>	62.5	62.5	
Sound power level (measured in anechoic room)	dB <A>	86	86	
Refrigerant piping diameter	High pressure mm (in.)	19.05 (3/4) Brazed	19.05 (3/4) Brazed	
	Low pressure mm (in.)	22.2 (7/8) Brazed	28.58 (1-1/8) Brazed	
FAN	Type x Quantity	Propeller fan x 1	Propeller fan x 1	
	Air flow rate	m <sup>3</sup> /min	230	230
		L/s	3,833	3,833
		cfm	8,121	8,121
	Driving mechanism	Inverter-control, Direct-driven by motor	Inverter-control, Direct-driven by motor	
	Motor output kW	0.92 x 1	0.92 x 1	
*4 External static press.	0 Pa (0 mmH <sub>2</sub> O)	0 Pa (0 mmH <sub>2</sub> O)		
Compressor	Type x Quantity	Inverter scroll hermetic compressor	Inverter scroll hermetic compressor	
	Starting method	Inverter	Inverter	
	Motor output kW	8.1	10.5	
	Case heater kW	—	—	
External finish		Pre-coated galvanized steel sheets (+powder coating for -BS type) <MUNSELL 5Y 8/1 or similar>	Pre-coated galvanized steel sheets (+powder coating for -BS type) <MUNSELL 5Y 8/1 or similar>	
External dimension HxWxD	mm	1,710 (1,650 without legs) x 1,220 x 740	1,710 (1,650 without legs) x 1,220 x 740	
	in.	67-3/8 (65 without legs) x 48-1/16 x 29-3/16	67-3/8 (65 without legs) x 48-1/16 x 29-3/16	
Protection devices	High pressure protection	High pressure sensor, High pressure switch at 4.15 MPa (601 psi)	High pressure sensor, High pressure switch at 4.15 MPa (601 psi)	
	Inverter circuit (COMP/FAN)	Over-heat protection, Over-current protection	Over-heat protection, Over-current protection	
	Compressor	Over-heat protection	Over-heat protection	
	Fan motor	Over-current protection	Over-current protection	
Refrigerant	Type x original charge	R410A x 10.3 kg (23 lbs)	R410A x 10.3 kg (23 lbs)	
Net weight	kg (lbs)	248 (547)	248 (547)	
Heat exchanger		Salt-resistant cross fin & copper tube	Salt-resistant cross fin & copper tube	
Optional parts		Joint: CMB-Y102SS-G2,CMB-Y102LS-G2,CMB-R160-J1 BC controller: CMB-P104,105,106,108,1010,1013,1016V-G1 Main BC controller: CMB-P108,1010,1013,1016V-GA1 Sub BC controller: CMB-P104,108V-GB1,CMB-P1016V-HB1	Joint: CMB-Y102SS-G2,CMB-Y102LS-G2,CMB-R160-J1 BC controller: CMB-P104,105,106,108,1010,1013,1016V-G1 Main BC controller: CMB-P108,1010,1013,1016V-GA1 Sub BC controller: CMB-P104,108V-GB1,CMB-P1016V-HB1	

### Notes:

\*1,\*2 Nominal conditions

	Indoor	Outdoor	Pipe length	Level difference
Cooling	27°C DB/19°C WB (81°F DB/66°F WB)	35°C DB/24°C WB (95°F DB/75°F WB)	7.5m (24-9/16ft.)	0m (0ft.)
Heating	20°C DB/68°F DB)	7°C DB/6°C WB(45°F DB/43°F WB)	7.5m (24-9/16ft.)	0m (0ft.)

\*3 -5°C DB (23°F DB) / -6°C WB (21°F WB) to 21°C DB (70°F DB) / 15.5°C WB (60°F WB) with cooling/heating mixed operation.

\*4 External static pressure option is available (30Pa, 60Pa / 3.1mmH<sub>2</sub>O, 6.1mmH<sub>2</sub>O).

\*Nominal condition \*1,\*2 are subject to JIS B8615-1.

\*Due to continuing improvement, above specification may be subject to change without notice.



# OUTDOOR UNIT

## R2 Series

### PURY-P YSLM-A(-BS)



### ► Specifications

Model		PURY-P400YSLM-A (-BS)		PURY-P450YSLM-A (-BS)		PURY-P500YSLM-A (-BS)		
Power source		3-phase 4-wire 380-400-415 V 50/60 Hz		3-phase 4-wire 380-400-415 V 50/60 Hz		3-phase 4-wire 380-400-415 V 50/60 Hz		
Cooling capacity (Nominal)	*1 kW	45.0		50.0		56.0		
	*1 BTU / h	153,500		170,600		191,100		
	Power input kW	12.36		14.16		16.37		
	Current input A	20.8-19.8-19.1		23.9-22.7-21.8		27.6-26.2-25.3		
	EER kW / kW	3.64		3.53		3.42		
Temp. range of cooling	*3 Indoor W.B.	15.0-24.0°C (59-75°F)		15.0-24.0°C (59-75°F)		15.0-24.0°C (59-75°F)		
	Outdoor D.B.	-5.0-46.0°C (23-115°F)		-5.0-46.0°C (23-115°F)		-5.0-46.0°C (23-115°F)		
Heating capacity (Nominal)	*2 kW	50.0		56.0		63.0		
	*2 BTU / h	170,600		191,100		215,000		
	Power input kW	13.08		15.01		17.30		
	Current input A	22.0-20.9-20.2		25.3-24.0-23.2		29.2-27.7-26.7		
	COP kW / kW	3.82		3.73		3.64		
Temp. range of heating	*3 Indoor D.B.	15.0-27.0°C (59-81°F)		15.0-27.0°C (59-81°F)		15.0-27.0°C (59-81°F)		
	Outdoor W.B.	-20.0-15.5°C (-4-60°F)		-20.0-15.5°C (-4-60°F)		-20.0-15.5°C (-4-60°F)		
Indoor unit connectable	Total capacity	50-150% of outdoor unit capacity		50-150% of outdoor unit capacity		50-150% of outdoor unit capacity		
	Model / Quantity	P15-P250/1-40		P15-P250/1-45		P15-P250/1-50		
Sound pressure level (measured in anechoic room)	dB <A>	62		62.5		63		
Sound power level (measured in anechoic room)	dB <A>	85.5		86		86.5		
Refrigerant piping diameter	High pressure mm (in.)	22.2 (7/8) Brazed		22.2 (7/8) Brazed		22.2 (7/8) Brazed		
	Low pressure mm (in.)	28.58 (1-1/8) Brazed		28.58 (1-1/8) Brazed		28.58 (1-1/8) Brazed		
<b>Set Model</b>								
Model		PURY-P200YLM-A (-BS)		PURY-P250YLM-A (-BS)		PURY-P250YLM-A (-BS)		
FAN	Type x Quantity	Propeller fan x 1		Propeller fan x 1		Propeller fan x 1		
	Air flow rate	m <sup>3</sup> /min	185		185		185	
		L/s	3,083		3,083		3,083	
		cfm	6,532		6,532		6,532	
	Driving mechanism	Inverter-control, Direct-driven by motor		Inverter-control, Direct-driven by motor		Inverter-control, Direct-driven by motor		
*4 Motor output kW	0.92 x 1		0.92 x 1		0.92 x 1			
External static press.	0 Pa (0 mmH <sub>2</sub> O)		0 Pa (0 mmH <sub>2</sub> O)		0 Pa (0 mmH <sub>2</sub> O)			
Compressor	Type x Quantity	Inverter scroll hermetic compressor		Inverter scroll hermetic compressor		Inverter scroll hermetic compressor		
	Starting method	Inverter		Inverter		Inverter		
	Motor output kW	5.6		5.6		6.9		
	Case heater kW	-		-		-		
External finish		Pre-coated galvanized steel sheets (+powder coating for -BS type) <MUNSELL 5Y 8/1 or similar>		Pre-coated galvanized steel sheets (+powder coating for -BS type) <MUNSELL 5Y 8/1 or similar>		Pre-coated galvanized steel sheets (+powder coating for -BS type) <MUNSELL 5Y 8/1 or similar>		
External dimension HxWxD	mm	1,710 (1,650 without legs) x 920 x 740		1,710 (1,650 without legs) x 920 x 740		1,710 (1,650 without legs) x 920 x 740		
	in.	67-3/8 (65 without legs) x 36-1/4 x 29-3/16		67-3/8 (65 without legs) x 36-1/4 x 29-3/16		67-3/8 (65 without legs) x 36-1/4 x 29-3/16		
Protection devices	High pressure protection	High pressure sensor, High pressure switch at 4.15 MPa (601 psi)		High pressure sensor, High pressure switch at 4.15 MPa (601 psi)		High pressure sensor, High pressure switch at 4.15 MPa (601 psi)		
	Inverter circuit (COMP/FAN)	Over-heat protection, Over-current protection		Over-heat protection, Over-current protection		Over-heat protection, Over-current protection		
	Compressor	Over-heat protection   Over-heat protection		Over-heat protection   Over-heat protection		Over-heat protection   Over-heat protection		
	Fan motor	Over-current protection		Over-current protection		Over-current protection		
Refrigerant	Type x original charge	R410A x 9.5 kg (21 lbs)   R410A x 9.5 kg (21 lbs)		R410A x 9.5 kg (21 lbs)   R410A x 9.5 kg (21 lbs)		R410A x 9.5 kg (21 lbs)   R410A x 9.5 kg (21 lbs)		
Net weight	kg (lbs)	205 (452)   205 (452)		205 (452)   205 (452)		205 (452)   205 (452)		
Heat exchanger		Salt-resistant cross fin & copper tube		Salt-resistant cross fin & copper tube		Salt-resistant cross fin & copper tube		
Pipe between unit and distributor	High pressure mm (in.)	15.88 (5/8) Brazed   15.88 (5/8) Brazed		15.88 (5/8) Brazed   19.05 (3/4) Brazed		19.05 (3/4) Brazed   19.05 (3/4) Brazed		
	Low pressure mm (in.)	19.05 (3/4) Brazed   -		19.05 (3/4) Brazed   -		22.2 (7/8) Brazed   -		
Outdoor parts		Outdoor Twinning kit: CMY-R100VBK-A Joint: CMY-Y102S-G2, CMY-Y102L-G2, CMY-R160-J1 Main BC controller: CMB-P108, 1010, 1013, 1016V-GA1 Sub BC controller: CMB-P104, 108V-GB1, CMB-P1016V-HB1		Outdoor Twinning kit: CMY-R100VBK-A Joint: CMY-Y102S-G2, CMY-Y102L-G2, CMY-R160-J1 Main BC controller: CMB-P108, 1010, 1013, 1016V-GA1 Sub BC controller: CMB-P104, 108V-GB1, CMB-P1016V-HB1		Outdoor Twinning kit: CMY-R100VBK-A Joint: CMY-Y102S-G2, CMY-Y102L-G2, CMY-R160-J1 Main BC controller: CMB-P108, 1010, 1013, 1016V-GA1 Sub BC controller: CMB-P104, 108V-GB1, CMB-P1016V-HB1		

#### Notes:

\*1, \*2 Nominal conditions

	Indoor	Outdoor	Pipe length	Level difference
Cooling	27°C DB/19°C WB (81°F DB/66°F WB)	35°C DB/24°C WB (95°F DB/75°F WB)	7.5m (24-9/16ft.)	0m (0ft.)
Heating	20°C DB/68°F DB)	7°C DB/6°C WB(45°F DB/43°F WB)	7.5m (24-9/16ft.)	0m (0ft.)

\*3 -5°C DB (23°F DB) / -6°C WB (21°F WB) to 21°C DB (70°F DB) / 15.5°C WB (60°F WB) with cooling/heating mixed operation.

\*4 External static pressure option is available (30Pa, 60Pa / 3.1mmH<sub>2</sub>O, 6.1mmH<sub>2</sub>O).

\*Nominal condition \*1, \*2 are subject to JIS B8615-1.

\*Due to continuing improvement, above specification may be subject to change without notice.



Outdoor Unit



# OUTDOOR UNIT

## R2 Series

### PURY-P YSLM-A(-BS)



### ► Specifications

Model		PURY-P550YSLM-A (-BS)		PURY-P600YSLM-A (-BS)		PURY-P650YSLM-A (-BS)		
Power source		3-phase 4-wire 380-400-415 V 50/60 Hz		3-phase 4-wire 380-400-415 V 50/60 Hz		3-phase 4-wire 380-400-415 V 50/60 Hz		
Cooling capacity (Nominal)	*1 kW	63.0		69.0		73.0		
	*1 BTU / h	215,000		235,400		249,100		
	Power input kW	18.75		20.90		22.95		
	Current input A	31.6-30.0-28.9		35.2-33.5-32.3		38.7-36.8-35.4		
	EER kW / kW	3.36		3.30		3.18		
Temp. range of cooling	*3 Indoor W.B.	15.0~24.0°C (59~75°F)		15.0~24.0°C (59~75°F)		15.0~24.0°C (59~75°F)		
	Outdoor D.B.	-5.0~46.0°C (23~115°F)		-5.0~46.0°C (23~115°F)		-5.0~46.0°C (23~115°F)		
Heating capacity (Nominal)	*2 kW	69.0		76.5		81.5		
	*2 BTU / h	235,400		261,000		278,100		
	Power input kW	19.38		21.98		23.48		
	Current input A	32.7-31.0-29.9		37.1-35.2-33.9		39.6-37.6-36.2		
	COP kW / kW	3.56		3.48		3.47		
Temp. range of heating	*3 Indoor D.B.	15.0~27.0°C (59~81°F)		15.0~27.0°C (59~81°F)		15.0~27.0°C (59~81°F)		
	Outdoor W.B.	-20.0~15.5°C (-4~60°F)		-20.0~15.5°C (-4~60°F)		-20.0~15.5°C (-4~60°F)		
Indoor unit connectable	Total capacity	50~150% of outdoor unit capacity		50~150% of outdoor unit capacity		50~150% of outdoor unit capacity		
	Model / Quantity	P15~P250/2~50		P15~P250/2~50		P15~P250/2~50		
Sound pressure level (measured in anechoic room)	dB <A>	64.5		65.5		65.5		
Sound power level (measured in anechoic room)	dB <A>	88		89		89		
Refrigerant piping diameter	High pressure mm (in.)	28.58 (1-1/8) Brazed		28.58 (1-1/8) Brazed		28.58 (1-1/8) Brazed		
	Low pressure mm (in.)	28.58 (1-1/8) Brazed		28.58 (1-1/8) Brazed		28.58 (1-1/8) Brazed		
<b>Set Model</b>								
Model		PURY-P250YLM-A (-BS)	PURY-P300YLM-A (-BS)	PURY-P300YLM-A (-BS)	PURY-P300YLM-A (-BS)	PURY-P300YLM-A (-BS)	PURY-P350YLM-A (-BS)	
FAN	Type x Quantity	Propeller fan x 1		Propeller fan x 1		Propeller fan x 1		
	Air flow rate	m <sup>3</sup> /min	185	230	230	230	230	230
		L/s	3,083	3,833	3,833	3,833	3,833	3,833
		cfm	6,532	8,121	8,121	8,121	8,121	8,121
	Driving mechanism	Inverter-control, Direct-driven by motor		Inverter-control, Direct-driven by motor		Inverter-control, Direct-driven by motor		Inverter-control, Direct-driven by motor
*4 Motor output kW	0.92 x 1		0.92 x 1		0.92 x 1		0.92 x 1	
External static press.	0 Pa (0 mmH <sub>2</sub> O)		0 Pa (0 mmH <sub>2</sub> O)		0 Pa (0 mmH <sub>2</sub> O)		0 Pa (0 mmH <sub>2</sub> O)	
Compressor	Type x Quantity	Inverter scroll hermetic compressor		Inverter scroll hermetic compressor		Inverter scroll hermetic compressor		
	Starting method	Inverter		Inverter		Inverter		
	Motor output kW	6.9		8.1		8.1		
	Case heater kW	-		-		-		
External finish	Pre-coated galvanized steel sheets (+powder coating for -BS type) <MUNSELL 5Y 8/1 or similar>		Pre-coated galvanized steel sheets (+powder coating for -BS type) <MUNSELL 5Y 8/1 or similar>		Pre-coated galvanized steel sheets (+powder coating for -BS type) <MUNSELL 5Y 8/1 or similar>		Pre-coated galvanized steel sheets (+powder coating for -BS type) <MUNSELL 5Y 8/1 or similar>	
External dimension HxWxD	mm	1,710 (1,650 without legs) x 920 x 740	1,710 (1,650 without legs) x 1,220 x 740	1,710 (1,650 without legs) x 1,220 x 740	1,710 (1,650 without legs) x 1,220 x 740	1,710 (1,650 without legs) x 1,220 x 740	1,710 (1,650 without legs) x 1,220 x 740	
	in.	67-3/8 (65 without legs) x 36-1/4 x 29-3/16	67-3/8 (65 without legs) x 48-1/16 x 29-3/16	67-3/8 (65 without legs) x 48-1/16 x 29-3/16	67-3/8 (65 without legs) x 48-1/16 x 29-3/16	67-3/8 (65 without legs) x 48-1/16 x 29-3/16	67-3/8 (65 without legs) x 48-1/16 x 29-3/16	
Protection devices	High pressure protection	High pressure sensor, High pressure switch at 4.15 MPa (601 psi)		High pressure sensor, High pressure switch at 4.15 MPa (601 psi)		High pressure sensor, High pressure switch at 4.15 MPa (601 psi)		
	Inverter circuit (COMP./FAN)	Over-heat protection, Over-current protection		Over-heat protection, Over-current protection		Over-heat protection, Over-current protection		
	Compressor	Over-heat protection   Over-heat protection		Over-heat protection   Over-heat protection		Over-heat protection   Over-heat protection		
	Fan motor	Over-current protection		Over-current protection		Over-current protection		
Refrigerant	Type x original charge	R410A x 9.5 kg (21 lbs)	R410A x 10.3 kg (23 lbs)	R410A x 10.3 kg (23 lbs)	R410A x 10.3 kg (23 lbs)	R410A x 10.3 kg (23 lbs)	R410A x 10.3 kg (23 lbs)	
Net weight	kg (lbs)	205 (452)	248 (547)	248 (547)	248 (547)	248 (547)	248 (547)	
Heat exchanger	Salt-resistant cross fin & copper tube		Salt-resistant cross fin & copper tube		Salt-resistant cross fin & copper tube		Salt-resistant cross fin & copper tube	
Pipe between unit and distributor	High pressure mm (in.)	19.05 (3/4) Brazed		19.05 (3/4) Brazed		19.05 (3/4) Brazed		
	Low pressure mm (in.)	22.2 (7/8) Brazed		22.2 (7/8) Brazed		22.2 (7/8) Brazed		
Optional parts	Outdoor Twinning kit: CMY-R100VBK2 Joint: CMY-Y102SS-G2, CMY-Y102LS-G2, CMY-R160-J1 Main BC controller: CMB-P108, 1010, 1013, 1016V-GA1 Sub BC controller: CMB-P104, 108V-GB1, CMB-P1016V-HB1		Outdoor Twinning kit: CMY-R100VBK2 Joint: CMY-Y102SS-G2, CMY-Y102LS-G2, CMY-R160-J1 Main BC controller: CMB-P108, 1010, 1013, 1016V-GA1 Sub BC controller: CMB-P104, 108V-GB1, CMB-P1016V-HB1		Outdoor Twinning kit: CMY-R100VBK2 Joint: CMY-Y102SS-G2, CMY-Y102LS-G2, CMY-R160-J1 Main BC controller: CMB-P108, 1010, 1013, 1016V-GA1 Sub BC controller: CMB-P104, 108V-GB1, CMB-P1016V-HB1		Outdoor Twinning kit: CMY-R100VBK2 Joint: CMY-Y102SS-G2, CMY-Y102LS-G2, CMY-R160-J1 Main BC controller: CMB-P108, 1010, 1013, 1016V-GA1 Sub BC controller: CMB-P104, 108V-GB1, CMB-P1016V-HB1	

#### Notes:

\*1, \*2 Nominal conditions

	Indoor	Outdoor	Pipe length	Level difference
Cooling	27°C DB/19°C WB (81°F DB/66°F WB)	35°C DB/24°C WB (95°F DB/75°F WB)	7.5m (24-9/16ft.)	0m (0ft.)
Heating	20°C DB/68°F DB)	7°C DB/6°C WB(45°F DB/43°F WB)	7.5m (24-9/16ft.)	0m (0ft.)

\*3 -5°C DB (23°F DB) / -6°C WB (21°F WB) to 21°C DB (70°F DB) / 15.5°C WB (60°F WB) with cooling/heating mixed operation.

\*4 External static pressure option is available (30Pa, 60Pa / 3.1mmH<sub>2</sub>O, 6.1mmH<sub>2</sub>O).

\*Nominal condition \*1, \*2 are subject to JIS B8615-1.

\*Due to continuing improvement, above specification may be subject to change without notice.



# OUTDOOR UNIT

## R2 Series

### PURY-P YSLM-A(-BS)



## ► Specifications

Model		PURY-P700YSLM-A (-BS)		PURY-P750YSLM-A (-BS)		PURY-P800YSLM-A (-BS)		
Power source		3-phase 4-wire 380-400-415 V 50/60 Hz		3-phase 4-wire 380-400-415 V 50/60 Hz		3-phase 4-wire 380-400-415 V 50/60 Hz		
Cooling capacity (Nominal)	*1 kW	80.0		85.0		90.0		
	*1 BTU / h	273,000		290,000		307,100		
	Power input kW	26.22		28.23		30.30		
	Current input A	44.2-42.0-40.5		47.6-45.2-43.6		51.1-48.5-46.8		
EER	kW / kW	3.05		3.01		2.97		
Temp. range of cooling	*3 Indoor W.B.	15.0~24.0°C (59~75°F)		15.0~24.0°C (59~75°F)		15.0~24.0°C (59~75°F)		
	Outdoor D.B.	-5.0~46.0°C (23~115°F)		-5.0~46.0°C (23~115°F)		-5.0~46.0°C (23~115°F)		
Heating capacity (Nominal)	*2 kW	88.0		90.0		90.0		
	*2 BTU / h	300,300		307,100		307,100		
	Power input kW	25.43		25.49		24.93		
	Current input A	42.9-40.7-39.3		43.0-40.8-39.4		42.0-39.9-38.5		
COP	kW / kW	3.46		3.53		3.61		
Temp. range of heating	*3 Indoor D.B.	15.0~27.0°C (59~81°F)		15.0~27.0°C (59~81°F)		15.0~27.0°C (59~81°F)		
	Outdoor W.B.	-20.0~15.5°C (-4~60°F)		-20.0~15.5°C (-4~60°F)		-20.0~15.5°C (-4~60°F)		
Indoor unit connectable	Total capacity	50~150% of outdoor unit capacity		50~150% of outdoor unit capacity		50~150% of outdoor unit capacity		
	Model / Quantity	P15-P250/2-50		P15-P250/2-50		P15-P250/2-50		
Sound pressure level (measured in anechoic room)	dB <A>	65.5		65.5		65.5		
Sound power level (measured in anechoic room)	dB <A>	89		89		89		
Refrigerant piping diameter	High pressure mm (in.)	28.58 (1-1/8) Brazed		28.58 (1-1/8) Brazed		28.58 (1-1/8) Brazed		
	Low pressure mm (in.)	34.93 (1-3/8) Brazed		34.93 (1-3/8) Brazed		34.93 (1-3/8) Brazed		
<b>Set Model</b>								
Model		PURY-P350YLM-A (-BS)	PURY-P350YLM-A (-BS)	PURY-P350YLM-A (-BS)	PURY-P400YLM-A (-BS)	PURY-P400YLM-A (-BS)	PURY-P400YLM-A (-BS)	
FAN	Type x Quantity	Propeller fan x 1		Propeller fan x 1		Propeller fan x 1		
	Air flow rate	m <sup>3</sup> /min	230		230		230	
		L/s	3,833		3,833		3,833	
		cfm	8,121		8,121		8,121	
Driving mechanism	Inverter-control, Direct-driven by motor		Inverter-control, Direct-driven by motor		Inverter-control, Direct-driven by motor			
Motor output	kW	0.92 x 1		0.92 x 1		0.92 x 1		
External static press.		0 Pa (0 mmH <sub>2</sub> O)		0 Pa (0 mmH <sub>2</sub> O)		0 Pa (0 mmH <sub>2</sub> O)		
Compressor	Type x Quantity	Inverter scroll hermetic compressor		Inverter scroll hermetic compressor		Inverter scroll hermetic compressor		
	Starting method	Inverter		Inverter		Inverter		
	Motor output	kW	10.5		10.5		10.9	
	Case heater	kW	-		-		-	
External finish		Pre-coated galvanized steel sheets (+powder coating for -BS type) <MUNSELL 5Y 8/1 or similar>		Pre-coated galvanized steel sheets (+powder coating for -BS type) <MUNSELL 5Y 8/1 or similar>		Pre-coated galvanized steel sheets (+powder coating for -BS type) <MUNSELL 5Y 8/1 or similar>		
External dimension HxWxD	mm	1,710 (1,650 without legs) x 1,220 x 740		1,710 (1,650 without legs) x 1,220 x 740		1,710 (1,650 without legs) x 1,220 x 740		
	in.	67-3/8 (65 without legs) x 48-1/16 x 29-3/16		67-3/8 (65 without legs) x 48-1/16 x 29-3/16		67-3/8 (65 without legs) x 48-1/16 x 29-3/16		
Protection devices	High pressure protection	High pressure sensor, High pressure switch at 4.15 MPa (601 psi)		High pressure sensor, High pressure switch at 4.15 MPa (601 psi)		High pressure sensor, High pressure switch at 4.15 MPa (601 psi)		
	Inverter circuit (COMP/FAN)	Over-heat protection, Over-current protection		Over-heat protection, Over-current protection		Over-heat protection, Over-current protection		
	Compressor	Over-heat protection   Over-heat protection		Over-heat protection   Over-heat protection		Over-heat protection   Over-heat protection		
	Fan motor	Over-current protection		Over-current protection		Over-current protection		
Refrigerant	Type x original charge	R410A x 10.3 kg (23 lbs)	R410A x 10.3 kg (23 lbs)	R410A x 10.3 kg (23 lbs)	R410A x 10.3 kg (23 lbs)	R410A x 10.3 kg (23 lbs)		
Net weight	kg (lbs)	248 (547)		248 (547)		246 (543)		
Heat exchanger		Salt-resistant cross fin & copper tube		Salt-resistant cross fin & copper tube		Salt-resistant cross fin & copper tube		
Pipe between unit and distributor	High pressure mm (in.)	19.05 (3/4) Brazed		19.05 (3/4) Brazed		22.2 (7/8) Brazed		
	Low pressure mm (in.)	28.58 (1-1/8) Brazed		28.58 (1-1/8) Brazed		28.58 (1-1/8) Brazed		
Outdoor parts		Outdoor Twinning kit: CMY-R200VBK2 Joint: CMY-Y102SS-G2,CMY-Y102LS-G2,CMY-R160-J1 Main BC controller: CMB-P1016V-HA1 Sub BC controller: CMB-P104,108V-GB1,CMB-P1016V-HB1		Outdoor Twinning kit: CMY-R200VBK2 Joint: CMY-Y102SS-G2,CMY-Y102LS-G2,CMY-R160-J1 Main BC controller: CMB-P1016V-HA1 Sub BC controller: CMB-P104,108V-GB1,CMB-P1016V-HB1		Outdoor Twinning kit: CMY-R200VBK2 Joint: CMY-Y102SS-G2,CMY-Y102LS-G2,CMY-R160-J1 Main BC controller: CMB-P1016V-HA1 Sub BC controller: CMB-P104,108V-GB1,CMB-P1016V-HB1		

### Notes:

\*1,\*2 Nominal conditions

	Indoor	Outdoor	Pipe length	Level difference
Cooling	27°C DB/19°C WB (81°F DB/66°F WB)	35°C DB/24°C WB (95°F DB/75°F WB)	7.5m (24-9/16ft.)	0m (0ft.)
Heating	20°C DB/68°F DB)	7°C DB/6°C WB(45°F DB/43°F WB)	7.5m (24-9/16ft.)	0m (0ft.)

\*3 -5°C DB (23°F DB) / -6°C WB (21°F WB) to 21°C DB (70°F DB) / 15.5°C WB (60°F WB) with cooling/heating mixed operation.

\*4 External static pressure option is available (30Pa, 60Pa / 3.1mmH<sub>2</sub>O, 6.1mmH<sub>2</sub>O).

\*Nominal condition \*1,\*2 are subject to JIS B8615-1.

\*Due to continuing improvement, above specification may be subject to change without notice.



Outdoor Unit

# OUTDOOR UNIT

## R2 Series

### PURY-P YSLM-A(-BS)



## ► Specifications

Model	PURY-P850YSLM-A (-BS)		PURY-P900YSLM-A (-BS)		
Power source	3-phase 4-wire 380-400-415 V 50/60 Hz		3-phase 4-wire 380-400-415 V 50/60 Hz		
Cooling capacity (Nominal)	*1 kW	96.0	101.0		
	*1 BTU / h	327,600	344,600		
	Power input kW	31.16	31.56		
	Current input A	52.6-49.9-48.1	53.2-50.6-48.7		
EER	kW / kW	3.08	3.20		
Temp. range of cooling	*3 Indoor W.B.	15.0~24.0°C (59~75°F)	15.0~24.0°C (59~75°F)		
	Outdoor D.B.	-5.0~46.0°C (23~115°F)	-5.0~46.0°C (23~115°F)		
Heating capacity (Nominal)	*2 kW	101.0	113.0		
	*2 BTU / h	344,600	385,600		
	Power input kW	28.53	32.47		
	Current input A	48.1-45.7-44.1	54.8-52.0-50.1		
COP	kW / kW	3.54	3.48		
Temp. range of heating	*3 Indoor D.B.	15.0~27.0°C (59~81°F)	15.0~27.0°C (59~81°F)		
	Outdoor W.B.	-20.0~15.5°C (-4~60°F)	-20.0~15.5°C (-4~60°F)		
Indoor unit connectable	Total capacity	50~150% of outdoor unit capacity	50~150% of outdoor unit capacity		
	Model / Quantity	P15~P250/2~50	P15~P250/2~50		
Sound pressure level (measured in anechoic room)	dB <A>	65.5	65.5		
Sound power level (measured in anechoic room)	dB <A>	89	89		
Refrigerant piping diameter	High pressure mm (in.)	28.58 (1-1/8) Brazed	28.58 (1-1/8) Brazed		
	Low pressure mm (in.)	41.28 (1-5/8) Brazed	41.28 (1-5/8) Brazed		
<b>Set Model</b>					
Model	PURY-P400YLM-A (-BS)		PURY-P450YLM-A (-BS)		
FAN	Type x Quantity	Propeller fan x 1	Propeller fan x 2	Propeller fan x 2	
	Air flow rate	m <sup>3</sup> /min	230	320	320
		L/s	3,833	5,333	5,333
		cfm	8,121	11,299	11,299
	Driving mechanism	Inverter-control, Direct-driven by motor			
Motor output	kW	0.92 x 1	0.92 x 2	0.92 x 2	
	External static press.	0 Pa (0 mmH <sub>2</sub> O)	0 Pa (0 mmH <sub>2</sub> O)	0 Pa (0 mmH <sub>2</sub> O)	
Compressor	Type x Quantity	Inverter scroll hermetic compressor		Inverter scroll hermetic compressor	
	Starting method	Inverter	Inverter	Inverter	
	Motor output kW	10.9	12.4	12.4	
	Case heater kW	-	-	-	
External finish	Pre-coated galvanized steel sheets (+powder coating for -BS type) <MUNSELL 5Y 8/1 or similar>		Pre-coated galvanized steel sheets (+powder coating for -BS type) <MUNSELL 5Y 8/1 or similar>		
External dimension HxWxD	mm	1,710 (1,650 without legs) x 1,220 x 740	1,710 (1,650 without legs) x 1,750 x 740	1,710 (1,650 without legs) x 1,750 x 740	
	in.	67-3/8 (65 without legs) x 48-1/16 x 29-3/16	67-3/8 (65 without legs) x 68-15/16 x 29-3/16	67-3/8 (65 without legs) x 68-15/16 x 29-3/16	
Protection devices	High pressure protection	High pressure sensor, High pressure switch at 4.15 MPa (601 psi)		High pressure sensor, High pressure switch at 4.15 MPa (601 psi)	
	Inverter circuit (COMP/FAN)	Over-heat protection, Over-current protection		Over-heat protection, Over-current protection	
	Compressor	Over-heat protection	Over-heat protection	Over-heat protection	
	Fan motor	Over-current protection	Over-current protection	Over-current protection	
Refrigerant	Type x original charge	R410A x 10.3 kg (23 lbs)	R410A x 11.8 kg (27 lbs)	R410A x 11.8 kg (27 lbs)	
Net weight	kg (lbs)	246 (543)	321 (708)	321 (708)	
Heat exchanger	Salt-resistant cross fin & copper tube				
Pipe between unit and distributor	High pressure mm (in.)	22.2 (7/8) Brazed	22.2 (7/8) Brazed	22.2 (7/8) Brazed	
	Low pressure mm (in.)	28.58 (1-1/8) Brazed	-	28.58 (1-1/8) Brazed	
Optional parts	Outdoor Twinning kit: CMY-R200XLVBK Joint: CMY-Y102SS-G2, CMY-Y102LS-G2, CMY-R160-J1 Main BC controller: CMB-P1016V-HA1 Sub BC controller: CMB-P104, 108V-GB1, CMB-P1016V-HB1		Outdoor Twinning kit: CMY-R200XLVBK Joint: CMY-Y102SS-G2, CMY-Y102LS-G2, CMY-R160-J1 Main BC controller: CMB-P1016V-HA1 Sub BC controller: CMB-P104, 108V-GB1, CMB-P1016V-HB1		

### Notes:

\*1, \*2 Nominal conditions

	Indoor	Outdoor	Pipe length	Level difference
Cooling	27°C DB/19°C WB (81°F DB/66°F WB)	35°C DB/24°C WB (95°F DB/75°F WB)	7.5m (24-9/16ft.)	0m (0ft.)
Heating	20°C DB/68°F DB)	7°C DB/6°C WB(45°F DB/43°F WB)	7.5m (24-9/16ft.)	0m (0ft.)

\*3 -5°C DB (23°F DB) / -6°C WB (21°F WB) to 21°C DB (70°F DB) / 15.5°C WB (60°F WB) with cooling/heating mixed operation.

\*4 External static pressure option is available (30Pa, 60Pa / 3.1mmH<sub>2</sub>O, 6.1mmH<sub>2</sub>O).

\*Nominal condition \*1, \*2 are subject to JIS B8615-1.

\*Due to continuing improvement, above specification may be subject to change without notice.



# OUTDOOR UNIT R2 Series - High COP PURY-EP YLM-A(-BS)



## ► Specifications

Model	PURY-EP200YLM-A (-BS)		PURY-EP250YLM-A (-BS)		PURY-EP300YLM-A (-BS)	
Power source	3-phase 4-wire 380-400-415 V 50/60 Hz		3-phase 4-wire 380-400-415 V 50/60 Hz		3-phase 4-wire 380-400-415 V 50/60 Hz	
Cooling capacity (Nominal)	*1	kW	22.4		33.5	
	*1	BTU / h	76,400		114,300	
		Power input kW	5.48		9.20	
		Current input A	9.2-8.7-8.4		15.5-14.7-14.2	
		EER kW / kW	4.08		3.64	
Temp. range of cooling	*3	Indoor W.B.	15.0~24.0°C (59~75°F)		15.0~24.0°C (59~75°F)	
		Outdoor D.B.	-5.0~46.0°C (23~115°F)		-5.0~46.0°C (23~115°F)	
Heating capacity (Nominal)	*2	kW	25.0		37.5	
	*2	BTU / h	85,300		128,000	
		Power input kW	6.41		9.97	
		Current input A	10.8-10.2-9.9		16.8-15.9-15.4	
		COP kW / kW	3.90		3.76	
Temp. range of heating	*3	Indoor D.B.	15.0~27.0°C (59~81°F)		15.0~27.0°C (59~81°F)	
		Outdoor W.B.	-20.0~15.5°C (-4~60°F)		-20.0~15.5°C (-4~60°F)	
Indoor unit connectable	Total capacity		50~150%		50~150% of outdoor unit capacity	
	Model / Quantity		P15~P250/1~20		P15~P250/1~25	
Sound pressure level (measured in anechoic room)	dB <A>		59		60	
Sound power level (measured in anechoic room)	dB <A>		82.5		83.5	
Refrigerant piping diameter	High pressure mm (in.)		15.88 (5/8) Brazed		19.05 (3/4) Brazed	
	Low pressure mm (in.)		19.05 (3/4) Brazed		22.2 (7/8) Brazed	
FAN	Type x Quantity		Propeller fan x 1		Propeller fan x 1	
	Air flow rate	m <sup>3</sup> /min	185		230	
		L/s	3,083		3,833	
		cfm	6,532		8,121	
	Driving mechanism		Inverter-control, Direct-driven by motor		Inverter-control, Direct-driven by motor	
	Motor output kW		0.92 x 1		0.92 x 1	
	*4 External static press.		0 Pa (0 mmH <sub>2</sub> O)		0 Pa (0 mmH <sub>2</sub> O)	
Compressor	Type x Quantity		Inverter scroll hermetic compressor		Inverter scroll hermetic compressor	
	Starting method		Inverter		Inverter	
	Motor output kW		5.6		6.9	
	Case heater kW		-		-	
External finish		Pre-coated galvanized steel sheets (+powder coating for -BS type) <MUNSELL 5Y 8/1 or similar>		Pre-coated galvanized steel sheets (+powder coating for -BS type) <MUNSELL 5Y 8/1 or similar>		
External dimension HxWxD	mm		1,710 (1,650 without legs) x 920 x 740		1,710 (1,650 without legs) x 1,220 x 740	
	in.		67-3/8 (65 without legs) x 36-1/4 x 29-3/16		67-3/8 (65 without legs) x 48-1/16 x 29-3/16	
Protection devices	High pressure protection		High pressure sensor, High pressure switch at 4.15 MPa (601 psi)		High pressure sensor, High pressure switch at 4.15 MPa (601 psi)	
	Inverter circuit (COMP./FAN)		Over-heat protection, Over-current protection		Over-heat protection, Over-current protection	
	Compressor		Over-heat protection		Over-heat protection	
	Fan motor		Over-current protection		Over-current protection	
Refrigerant	Type x original charge		R410A x 8.5 kg (19 lbs)		R410A x 9.3 kg (21 lbs)	
Net weight	kg (lbs)		218 (481)		260 (574)	
Heat exchanger			Salt-resistant cross fin & aluminium tube		Salt-resistant cross fin & aluminium tube	
Optional parts			Joint: CMY-Y102SS-G2, CMY-Y102LS-G2, CMY-R160-J1 BC controller: CMB-P104, 105, 106, 108, 1010, 1013, 1016V-G1 Main BC controller: CMB-P108, 1010, 1013, 1016V-GA1 Sub BC controller: CMB-P104, 108V-GB1, CMB-P1016V-HB1		Joint: CMY-Y102SS-G2, CMY-Y102LS-G2, CMY-R160-J1 BC controller: CMB-P104, 105, 106, 108, 1010, 1013, 1016V-G1 Main BC controller: CMB-P108, 1010, 1013, 1016V-GA1 Sub BC controller: CMB-P104, 108V-GB1, CMB-P1016V-HB1	

### Notes:

\*1, \*2 Nominal conditions

	Indoor	Outdoor	Pipe length	Level difference
Cooling	27°C DB/19°C WB (81°F DB/66°F WB)	35°C DB/24°C WB (95°F DB/75°F WB)	7.5m (24-9/16ft.)	0m (0ft.)
Heating	20°C DB/68°F DB)	7°C DB/6°C WB(45°F DB/43°F WB)	7.5m (24-9/16ft.)	0m (0ft.)

\*3 -5°C DB (23°F DB) / -6°C WB (21°F WB) to 21°C DB (70°F DB) / 15.5°C WB (60°F WB) with cooling/heating mixed operation.

\*4 External static pressure option is available (30Pa, 60Pa / 3.1mmH<sub>2</sub>O, 6.1mmH<sub>2</sub>O).

\*Nominal condition \*1, \*2 are subject to JIS B8615-1.

\*Due to continuing improvement, above specification may be subject to change without notice.



# OUTDOOR UNIT

## R2 Series - High COP

### PURY-EP YLM-A(-BS)



## ► Specifications

Model	PURY-EP350YLM-A (-BS)		PURY-EP400YLM-A (-BS)		PURY-EP450YLM-A (-BS)	
Power source	3-phase 4-wire 380-400-415 V 50/60 Hz		3-phase 4-wire 380-400-415 V 50/60 Hz		3-phase 4-wire 380-400-415 V 50/60 Hz	
Cooling capacity (Nominal)	*1	kW	40.0		50.0	
	*1	BTU / h	136,500		170,600	
		Power input kW	12.57		14.83	
		Current input A	21.2-20.1-19.4		25.0-23.7-22.9	
		EER kW / kW	3.18		3.37	
Temp. range of cooling	*3	Indoor W.B.	15.0~24.0°C (59~75°F)		15.0~24.0°C (59~75°F)	
		Outdoor D.B.	-5.0~46.0°C (23~115°F)		-5.0~46.0°C (23~115°F)	
Heating capacity (Nominal)	*2	kW	45.0		56.0	
	*2	BTU / h	153,500		191,100	
		Power input kW	12.93		15.86	
		Current input A	21.8-20.7-19.9		26.7-25.4-24.5	
		COP kW / kW	3.48		3.53	
Temp. range of heating	*3	Indoor D.B.	15.0~27.0°C (59~81°F)		15.0~27.0°C (59~81°F)	
		Outdoor W.B.	-20.0~15.5°C (-4~60°F)		-20.0~15.5°C (-4~60°F)	
Indoor unit connectable	Total capacity		50~150% of outdoor unit capacity		50~150% of outdoor unit capacity	
	Model / Quantity		P15~P250/1~35		P15~P250/1~40	
Sound pressure level (measured in anechoic room)	dB <A>		62.5		62.5	
Sound power level (measured in anechoic room)	dB <A>		86		86	
Refrigerant piping diameter	High pressure mm (in.)		19.05 (3/4) Brazed		22.2 (7/8) Brazed	
	Low pressure mm (in.)		28.58 (1-1/8) Brazed		28.58 (1-1/8) Brazed	
FAN	Type x Quantity		Propeller fan x 1		Propeller fan x 2	
	Air flow rate	m <sup>3</sup> /min	230		320	
		L/s	3,833		5,333	
		cfm	8,121		11,299	
	Driving mechanism		Inverter-control, Direct-driven by motor		Inverter-control, Direct-driven by motor	
	Motor output kW		0.92 x 1		0.92 x 2	
	*4 External static press.		0 Pa (0 mmH <sub>2</sub> O)		0 Pa (0 mmH <sub>2</sub> O)	
Compressor	Type x Quantity		Inverter scroll hermetic compressor		Inverter scroll hermetic compressor	
	Starting method		Inverter		Inverter	
	Motor output kW		10.5		10.9	
	Case heater kW		-		-	
External finish		Pre-coated galvanized steel sheets (+powder coating for -BS type) <MUNSELL 5Y 8/1 or similar>		Pre-coated galvanized steel sheets (+powder coating for -BS type) <MUNSELL 5Y 8/1 or similar>		
External dimension HxWxD	mm		1,710 (1,650 without legs) x 1,220 x 740		1,710 (1,650 without legs) x 1,750 x 740	
	in.		67-3/8 (65 without legs) x 48-1/16 x 29-3/16		67-3/8 (65 without legs) x 68-15/16 x 29-3/16	
Protection devices	High pressure protection		High pressure sensor, High pressure switch at 4.15 MPa (601 psi)		High pressure sensor, High pressure switch at 4.15 MPa (601 psi)	
	Inverter circuit (COMP./FAN)		Over-heat protection, Over-current protection		Over-heat protection, Over-current protection	
	Compressor		Over-heat protection		Over-heat protection	
	Fan motor		Over-current protection		Over-current protection	
Refrigerant	Type x original charge		R410A x 9.3 kg (21 lbs)		R410A x 11.8 kg (27 lbs)	
Net weight	kg (lbs)		260 (574)		338 (746)	
Heat exchanger			Salt-resistant cross fin & aluminium tube		Salt-resistant cross fin & aluminium tube	
Optional parts			Joint: CMY-Y102SS-G2, CMY-Y102LS-G2, CMY-R160-J1 BC controller: CMB-P104, 105, 106, 108, 1010, 1013, 1016V-G1 Main BC controller: CMB-P108, 1010, 1013, 1016V-GA1 Sub BC controller: CMB-P104, 108V-GB1, CMB-P1016V-HB1		Joint: CMY-Y102SS-G2, CMY-Y102LS-G2, CMY-R160-J1 Main BC controller: CMB-P108, 1010, 1013, 1016V-GA1 Sub BC controller: CMB-P104, 108V-GB1, CMB-P1016V-HB1	

### Notes:

\*1, \*2 Nominal conditions

	Indoor	Outdoor	Pipe length	Level difference
Cooling	27°C DB/19°C WB (81°F DB/66°F WB)	35°C DB/24°C WB (95°F DB/75°F WB)	7.5m (24-9/16ft.)	0m (0ft.)
Heating	20°C DB/68°F DB)	7°C DB/6°C WB(45°F DB/43°F WB)	7.5m (24-9/16ft.)	0m (0ft.)

\*3 -5°C DB (23°F DB) / -6°C WB (21°F WB) to 21°C DB (70°F DB) / 15.5°C WB (60°F WB) with cooling/heating mixed operation.

\*4 External static pressure option is available (30Pa, 60Pa / 3.1mmH<sub>2</sub>O, 6.1mmH<sub>2</sub>O).

\*Nominal condition \*1, \*2 are subject to JIS B8615-1.

\*Due to continuing improvement, above specification may be subject to change without notice.



# OUTDOOR UNIT

## R2 Series - High COP

### PURY-EP YSLM-A(-BS)



## ► Specifications

Model		PURY-EP500YSLM-A (-BS)		PURY-EP550YSLM-A (-BS)		PURY-EP600YSLM-A (-BS)		
Power source		3-phase 4-wire 380-400-415 V 50/60 Hz		3-phase 4-wire 380-400-415 V 50/60 Hz		3-phase 4-wire 380-400-415 V 50/60 Hz		
Cooling capacity (Nominal)	*1 kW	56.0		63.0		69.0		
	*1 BTU / h	191,100		215,000		235,400		
	Power input kW	14.97		17.35		19.54		
	Current input A	25.2-24.0-23.1		29.2-27.8-26.8		32.9-31.3-30.2		
EER	kW / kW	3.74		3.63		3.53		
Temp. range of cooling	*3 Indoor W.B.	15.0~24.0°C (59~75°F)		15.0~24.0°C (59~75°F)		15.0~24.0°C (59~75°F)		
	Outdoor D.B.	-5.0~46.0°C (23~115°F)		-5.0~46.0°C (23~115°F)		-5.0~46.0°C (23~115°F)		
Heating capacity (Nominal)	*2 kW	63.0		69.0		76.5		
	*2 BTU / h	215,000		235,400		261,000		
	Power input kW	16.93		18.44		20.34		
	Current input A	28.5-27.1-26.1		31.1-29.5-28.5		34.3-32.6-31.4		
COP	kW / kW	3.72		3.74		3.76		
Temp. range of heating	*3 Indoor D.B.	15.0~27.0°C (59~81°F)		15.0~27.0°C (59~81°F)		15.0~27.0°C (59~81°F)		
	Outdoor W.B.	-20.0~15.5°C (-4~60°F)		-20.0~15.5°C (-4~60°F)		-20.0~15.5°C (-4~60°F)		
Indoor unit connectable	Total capacity	50~150% of outdoor unit capacity		50~150% of outdoor unit capacity		50~150% of outdoor unit capacity		
	Model / Quantity	P15-P250/1-50		P15-P250/2-50		P15-P250/2-50		
Sound pressure level (measured in anechoic room)	dB <A>	63		64.5		65.5		
Sound power level (measured in anechoic room)	dB <A>	86.5		88		89		
Refrigerant piping diameter	High pressure mm (in.)	22.2 (7/8) Brazed		28.58 (1-1/8) Brazed		28.58 (1-1/8) Brazed		
	Low pressure mm (in.)	28.58 (1-1/8) Brazed		28.58 (1-1/8) Brazed		28.58 (1-1/8) Brazed		
<b>Set Model</b>								
Model		PURY-EP250YLM-A (-BS)	PURY-EP250YLM-A (-BS)	PURY-EP250YLM-A (-BS)	PURY-EP300YLM-A (-BS)	PURY-EP300YLM-A (-BS)	PURY-EP300YLM-A (-BS)	
FAN	Type x Quantity	Propeller fan x 1		Propeller fan x 1		Propeller fan x 1		
	Air flow rate	m <sup>3</sup> /min	185		185		230	
		L/s	3,083		3,083		3,833	
		cfm	6,532		6,532		8,121	
Driving mechanism	Inverter-control, Direct-driven by motor		Inverter-control, Direct-driven by motor		Inverter-control, Direct-driven by motor			
Motor output	kW	0.92 x 1		0.92 x 1		0.92 x 1		
External static press.		0 Pa (0 mmH <sub>2</sub> O)		0 Pa (0 mmH <sub>2</sub> O)		0 Pa (0 mmH <sub>2</sub> O)		
Compressor	Type x Quantity	Inverter scroll hermetic compressor		Inverter scroll hermetic compressor		Inverter scroll hermetic compressor		
	Starting method	Inverter		Inverter		Inverter		
	Motor output	kW	6.9		6.9		8.1	
	Case heater	kW	-		-		-	
External finish		Pre-coated galvanized steel sheets (+powder coating for -BS type) <MUNSELL 5Y 8/1 or similar>		Pre-coated galvanized steel sheets (+powder coating for -BS type) <MUNSELL 5Y 8/1 or similar>		Pre-coated galvanized steel sheets (+powder coating for -BS type) <MUNSELL 5Y 8/1 or similar>		
External dimension HxWxD	mm	1,710 (1,650 without legs) x 920 x 740		1,710 (1,650 without legs) x 920 x 740		1,710 (1,650 without legs) x 1,220 x 740		
	in.	67-3/8 (65 without legs) x 36-1/4 x 29-3/16		67-3/8 (65 without legs) x 36-1/4 x 29-3/16		67-3/8 (65 without legs) x 48-1/16 x 29-3/16		
Protection devices	High pressure protection	High pressure sensor, High pressure switch at 4.15 MPa (601 psi)		High pressure sensor, High pressure switch at 4.15 MPa (601 psi)		High pressure sensor, High pressure switch at 4.15 MPa (601 psi)		
	Inverter circuit (COMP/FAN)	Over-heat protection, Over-current protection		Over-heat protection, Over-current protection		Over-heat protection, Over-current protection		
	Compressor	Over-heat protection   Over-heat protection		Over-heat protection   Over-heat protection		Over-heat protection   Over-heat protection		
	Fan motor	Over-current protection		Over-current protection		Over-current protection		
Refrigerant	Type x original charge	R410A x 8.5 kg (19 lbs)	R410A x 8.5 kg (19 lbs)	R410A x 8.5 kg (19 lbs)	R410A x 9.3 kg (21 lbs)	R410A x 9.3 kg (21 lbs)	R410A x 9.3 kg (21 lbs)	
Net weight	kg (lbs)	218 (481)		218 (481)		260 (574)		
Heat exchanger		Salt-resistant cross fin & aluminium tube		Salt-resistant cross fin & aluminium tube		Salt-resistant cross fin & aluminium tube		
Pipe between unit and distributor	High pressure mm (in.)	19.05 (3/4) Brazed		19.05 (3/4) Brazed		19.05 (3/4) Brazed		
	Low pressure mm (in.)	22.2 (7/8) Brazed		22.2 (7/8) Brazed		22.2 (7/8) Brazed		
Optional parts		Outdoor Twinning kit: CMY-ER100VBK-A Joint: CMY-Y102S-G2,CMY-Y102L-G2,CMY-R160-J1 Main BC controller: CMB-P108,1010,1013,1016V-GA1 Sub BC controller: CMB-P104,108V-GB1,CMB-P1016V-HB1		Outdoor Twinning kit: CMY-ER200VBK Joint: CMY-Y102SS-G2,CMY-Y102LS-G2,CMY-R160-J1 Main BC controller: CMB-P108,1010,1013,1016V-GA1 Sub BC controller: CMB-P104,108V-GB1,CMB-P1016V-HB1		Outdoor Twinning kit: CMY-ER200VBK Joint: CMY-Y102SS-G2,CMY-Y102LS-G2,CMY-R160-J1 Main BC controller: CMB-P108,1010,1013,1016V-GA1 Sub BC controller: CMB-P104,108V-GB1,CMB-P1016V-HB1		

### Notes:

\*1,\*2 Nominal conditions

	Indoor	Outdoor	Pipe length	Level difference
Cooling	27°C DB/19°C WB (81°F DB/66°F WB)	35°C DB/24°C WB (95°F DB/75°F WB)	7.5m (24-9/16ft.)	0m (0ft.)
Heating	20°C DB/68°F DB)	7°C DB/6°C WB(45°F DB/43°F WB)	7.5m (24-9/16ft.)	0m (0ft.)

\*3 -5°C DB (23°F DB) / -6°C WB (21°F WB) to 21°C DB (70°F DB) / 15.5°C WB (60°F WB) with cooling/heating mixed operation.

\*4 External static pressure option is available (30Pa, 60Pa / 3.1mmH<sub>2</sub>O, 6.1mmH<sub>2</sub>O).

\*Nominal condition \*1,\*2 are subject to JIS B8615-1.

\*Due to continuing improvement, above specification may be subject to change without notice.



Outdoor Unit

# OUTDOOR UNIT

## R2 Series - High COP

### PURY-EP YSLM-A(-BS)



### ► Specifications

Model		PURY-EP650YSLM-A (-BS)		PURY-EP700YSLM-A (-BS)		PURY-EP750YSLM-A (-BS)		
Power source		3-phase 4-wire 380-400-415 V 50/60 Hz		3-phase 4-wire 380-400-415 V 50/60 Hz		3-phase 4-wire 380-400-415 V 50/60 Hz		
Cooling capacity (Nominal)	*1 kW	73.0		80.0		85.0		
	*1 BTU / h	249,100		273,000		290,000		
	Power input kW	22.12		25.97		25.99		
	Current input A	37.3-35.4-34.1		43.8-41.6-40.1		43.8-41.6-40.1		
EER	kW / kW	3.30		3.08		3.27		
Temp. range of cooling	*3 Indoor W.B.	15.0~24.0°C (59~75°F)		15.0~24.0°C (59~75°F)		15.0~24.0°C (59~75°F)		
	Outdoor D.B.	-5.0~46.0°C (23~115°F)		-5.0~46.0°C (23~115°F)		-5.0~46.0°C (23~115°F)		
Heating capacity (Nominal)	*2 kW	81.5		88.0		95.0		
	*2 BTU / h	278,100		300,300		324,100		
	Power input kW	22.51		25.28		26.38		
	Current input A	38.0-36.1-34.7		42.6-40.5-39.0		44.5-42.3-40.7		
COP	kW / kW	3.62		3.48		3.60		
Temp. range of heating	*3 Indoor D.B.	15.0~27.0°C (59~81°F)		15.0~27.0°C (59~81°F)		15.0~27.0°C (59~81°F)		
	Outdoor W.B.	-20.0~15.5°C (-4~60°F)		-20.0~15.5°C (-4~60°F)		-20.0~15.5°C (-4~60°F)		
Indoor unit connectable	Total capacity	50~150% of outdoor unit capacity		50~150% of outdoor unit capacity		50~150% of outdoor unit capacity		
	Model / Quantity	P15-P250/2-50		P15-P250/2-50		P15-P250/2-50		
Sound pressure level (measured in anechoic room)	dB <A>	65.5		65.5		65.5		
Sound power level (measured in anechoic room)	dB <A>	89		89		89		
Refrigerant piping diameter	High pressure mm (in.)	28.58 (1-1/8) Brazed		28.58 (1-1/8) Brazed		28.58 (1-1/8) Brazed		
	Low pressure mm (in.)	28.58 (1-1/8) Brazed		34.93 (1-3/8) Brazed		34.93 (1-3/8) Brazed		
<b>Set Model</b>								
Model		PURY-EP300YLM-A (-BS)		PURY-EP350YLM-A (-BS)		PURY-EP400YLM-A (-BS)		
FAN	Type x Quantity	Propeller fan x 1		Propeller fan x 1		Propeller fan x 2		
	Air flow rate	m <sup>3</sup> /min	230		230		320	
		L/s	3,833		3,833		5,333	
		cfm	8,121		8,121		11,299	
Driving mechanism	Inverter-control, Direct-driven by motor		Inverter-control, Direct-driven by motor		Inverter-control, Direct-driven by motor			
Motor output	kW	0.92 x 1		0.92 x 1		0.92 x 2		
External static press.		0 Pa (0 mmH <sub>2</sub> O)		0 Pa (0 mmH <sub>2</sub> O)		0 Pa (0 mmH <sub>2</sub> O)		
Compressor	Type x Quantity	Inverter scroll hermetic compressor		Inverter scroll hermetic compressor		Inverter scroll hermetic compressor		
	Starting method	Inverter		Inverter		Inverter		
	Motor output	kW	8.1		10.5		10.9	
	Case heater	kW	-		-		-	
External finish		Pre-coated galvanized steel sheets (+powder coating for -BS type) <MUNSELL 5Y 8/1 or similar>		Pre-coated galvanized steel sheets (+powder coating for -BS type) <MUNSELL 5Y 8/1 or similar>		Pre-coated galvanized steel sheets (+powder coating for -BS type) <MUNSELL 5Y 8/1 or similar>		
External dimension HxWxD	mm	1,710 (1,650 without legs) x 1,220 x 740		1,710 (1,650 without legs) x 1,220 x 740		1,710 (1,650 without legs) x 1,220 x 740		
	in.	67-3/8 (65 without legs) x 48-1/16 x 29-3/16		67-3/8 (65 without legs) x 48-1/16 x 29-3/16		67-3/8 (65 without legs) x 48-1/16 x 29-3/16		
Protection devices	High pressure protection	High pressure sensor, High pressure switch at 4.15 MPa (601 psi)		High pressure sensor, High pressure switch at 4.15 MPa (601 psi)		High pressure sensor, High pressure switch at 4.15 MPa (601 psi)		
	Inverter circuit (COMP./FAN)	Over-heat protection, Over-current protection		Over-heat protection, Over-current protection		Over-heat protection, Over-current protection		
	Compressor	Over-heat protection   Over-heat protection		Over-heat protection   Over-heat protection		Over-heat protection   Over-heat protection		
	Fan motor	Over-current protection		Over-current protection		Over-current protection		
Refrigerant	Type x original charge	R410A x 9.3 kg (21 lbs)		R410A x 9.3 kg (21 lbs)		R410A x 9.3 kg (21 lbs)		
Net weight	kg (lbs)	260 (574)		260 (574)		338 (746)		
Heat exchanger		Salt-resistant cross fin & aluminium tube		Salt-resistant cross fin & aluminium tube		Salt-resistant cross fin & aluminium tube		
Pipe between unit and distributor	High pressure	19.05 (3/4) Brazed		19.05 (3/4) Brazed		19.05 (3/4) Brazed		
	Low pressure	22.2 (7/8) Brazed		28.58 (1-1/8) Brazed		28.58 (1-1/8) Brazed		
Outdoor parts		Outdoor Twinning kit: CMY-ER200VBK Joint: CMY-Y102SS-G2, CMY-Y102LS-G2, CMY-R160-J1 Main BC controller: CMB-P108, 1010, 1013, 1016V-GA1 Sub BC controller: CMB-P104, 108V-GB1, CMB-P1016V-HB1		Outdoor Twinning kit: CMY-ER200VBK Joint: CMY-Y102SS-G2, CMY-Y102LS-G2, CMY-R160-J1 Main BC controller: CMB-P1016V-HA1 Sub BC controller: CMB-P104, 108V-GB1, CMB-P1016V-HB1		Outdoor Twinning kit: CMY-ER200VBK Joint: CMY-Y102SS-G2, CMY-Y102LS-G2, CMY-R160-J1 Main BC controller: CMB-P1016V-HA1 Sub BC controller: CMB-P104, 108V-GB1, CMB-P1016V-HB1		

#### Notes:

\*1, \*2 Nominal conditions

	Indoor	Outdoor	Pipe length	Level difference
Cooling	27°C DB/19°C WB (81°F DB/66°F WB)	35°C DB/24°C WB (95°F DB/75°F WB)	7.5m (24-9/16ft.)	0m (0ft.)
Heating	20°C DB/68°F DB)	7°C DB/6°C WB(45°F DB/43°F WB)	7.5m (24-9/16ft.)	0m (0ft.)

\*3 -5°C DB (23°F DB) / -6°C WB (21°F WB) to 21°C DB (70°F DB) / 15.5°C WB (60°F WB) with cooling/heating mixed operation.

\*4 External static pressure option is available (30Pa, 60Pa / 3.1mmH<sub>2</sub>O, 6.1mmH<sub>2</sub>O).

\*Nominal condition \*1, \*2 are subject to JIS B8615-1.

\*Due to continuing improvement, above specification may be subject to change without notice.



# OUTDOOR UNIT

## R2 Series - High COP

### PURY-EP YSLM-A(-BS)



### ► Specifications

Model		PURY-EP800YSLM-A (-BS)		PURY-EP850YSLM-A (-BS)		PURY-EP900YSLM-A (-BS)		
Power source		3-phase 4-wire 380-400-415 V 50/60 Hz		3-phase 4-wire 380-400-415 V 50/60 Hz		3-phase 4-wire 380-400-415 V 50/60 Hz		
Cooling capacity (Nominal)	*1 kW	90.0		96.0		101.0		
	*1 BTU / h	307,100		327,600		344,600		
	Power input kW	25.93		28.48		30.98		
	Current input A	43.7-41.5-40.0		48.0-45.6-44.0		52.2-49.6-47.8		
EER		3.47		3.37		3.26		
Temp. range of cooling	*3 Indoor W.B.	15.0~24.0°C (59~75°F)		15.0~24.0°C (59~75°F)		15.0~24.0°C (59~75°F)		
	Outdoor D.B.	-5.0~46.0°C (23~115°F)		-5.0~46.0°C (23~115°F)		-5.0~46.0°C (23~115°F)		
Heating capacity (Nominal)	*2 kW	100.0		108.0		113.0		
	*2 BTU / h	341,200		368,500		385,600		
	Power input kW	26.80		29.75		32.01		
	Current input A	45.2-42.9-41.4		50.2-47.7-45.9		54.0-51.3-49.4		
COP		3.73		3.63		3.53		
Temp. range of heating	*3 Indoor D.B.	15.0~27.0°C (59~81°F)		15.0~27.0°C (59~81°F)		15.0~27.0°C (59~81°F)		
	Outdoor W.B.	-20.0~15.5°C (-4~60°F)		-20.0~15.5°C (-4~60°F)		-20.0~15.5°C (-4~60°F)		
Indoor unit connectable	Total capacity	50~150% of outdoor unit capacity		50~150% of outdoor unit capacity		50~150% of outdoor unit capacity		
	Model / Quantity	P15~P250/2~50		P15~P250/2~50		P15~P250/2~50		
Sound pressure level (measured in anechoic room)	dB <A>	65.5		65.5		65.5		
Sound power level (measured in anechoic room)	dB <A>	89		89		89		
Refrigerant piping diameter	High pressure mm (in.)	28.58 (1-1/8) Brazed		28.58 (1-1/8) Brazed		28.58 (1-1/8) Brazed		
	Low pressure mm (in.)	34.93 (1-3/8) Brazed		41.28 (1-5/8) Brazed		41.28 (1-5/8) Brazed		
<b>Set Model</b>								
Model		PURY-EP400YLM-A (-BS)	PURY-EP400YLM-A (-BS)	PURY-EP400YLM-A (-BS)	PURY-EP450YLM-A (-BS)	PURY-EP450YLM-A (-BS)	PURY-EP450YLM-A (-BS)	
FAN	Type x Quantity	Propeller fan x 2		Propeller fan x 2		Propeller fan x 2		
	Air flow rate	m <sup>3</sup> /min	320		320		320	
		L/s	5,333		5,333		5,333	
		cfm	11,299		11,299		11,299	
Driving mechanism	Inverter-control, Direct-driven by motor		Inverter-control, Direct-driven by motor		Inverter-control, Direct-driven by motor			
Motor output	kW	0.92 x 1		0.92 x 2		0.92 x 2		
	External static press.	0 Pa (0 mmH <sub>2</sub> O)		0 Pa (0 mmH <sub>2</sub> O)		0 Pa (0 mmH <sub>2</sub> O)		
Compressor	Type x Quantity	Inverter scroll hermetic compressor		Inverter scroll hermetic compressor		Inverter scroll hermetic compressor		
	Starting method	Inverter		Inverter		Inverter		
	Motor output kW	10.9		10.9		12.4		
	Case heater kW	-		-		-		
External finish		Pre-coated galvanized steel sheets (+powder coating for -BS type) <MUNSELL 5Y 8/1 or similar>		Pre-coated galvanized steel sheets (+powder coating for -BS type) <MUNSELL 5Y 8/1 or similar>		Pre-coated galvanized steel sheets (+powder coating for -BS type) <MUNSELL 5Y 8/1 or similar>		
External dimension HxWxD	mm	1,710 (1,650 without legs) x 1,750 x 740		1,710 (1,650 without legs) x 1,750 x 740		1,710 (1,650 without legs) x 1,750 x 740		
	in.	67-3/8 (65 without legs) x 68-15/16 x 29-3/16		67-3/8 (65 without legs) x 68-15/16 x 29-3/16		67-3/8 (65 without legs) x 68-15/16 x 29-3/16		
Protection devices	High pressure protection	High pressure sensor, High pressure switch at 4.15 MPa (601 psi)		High pressure sensor, High pressure switch at 4.15 MPa (601 psi)		High pressure sensor, High pressure switch at 4.15 MPa (601 psi)		
	Inverter circuit (COMP./FAN)	Over-heat protection, Over-current protection		Over-heat protection, Over-current protection		Over-heat protection, Over-current protection		
	Compressor	Over-heat protection   Over-heat protection		Over-heat protection   Over-heat protection		Over-heat protection   Over-heat protection		
	Fan motor	Over-current protection		Over-current protection		Over-current protection		
Refrigerant	Type x original charge	R410A x 11.8 kg (27 lbs)	R410A x 11.8 kg (27 lbs)	R410A x 11.8 kg (27 lbs)	R410A x 11.8 kg (27 lbs)	R410A x 11.8 kg (27 lbs)		
Net weight	kg (lbs)	338 (746)		338 (746)		338 (746)		
Heat exchanger		Salt-resistant cross fin & aluminium tube		Salt-resistant cross fin & aluminium tube		Salt-resistant cross fin & aluminium tube		
Pipe between unit and distributor	High pressure mm (in.)	22.2 (7/8) Brazed		22.2 (7/8) Brazed		22.2 (7/8) Brazed		
	Low pressure mm (in.)	28.58 (1-1/8) Brazed		28.58 (1-1/8) Brazed		28.58 (1-1/8) Brazed		
Optional parts		Outdoor Twinning kit: CMY-ER200VBK Joint: CMY-Y102SS-G2, CMY-Y102LS-G2, CMY-R160-J1 Main BC controller: CMB-P1016V-HA1 Sub BC controller: CMB-P104, 108V-GB1, CMB-P1016V-HB1		Outdoor Twinning kit: CMY-ER200VBK Joint: CMY-Y102SS-G2, CMY-Y102LS-G2, CMY-R160-J1 Main BC controller: CMB-P1016V-HA1 Sub BC controller: CMB-P104, 108V-GB1, CMB-P1016V-HB1		Outdoor Twinning kit: CMY-ER200VBK Joint: CMY-Y102SS-G2, CMY-Y102LS-G2, CMY-R160-J1 Main BC controller: CMB-P1016V-HA1 Sub BC controller: CMB-P104, 108V-GB1, CMB-P1016V-HB1		

#### Notes:

\*1, \*2 Nominal conditions

	Indoor	Outdoor	Pipe length	Level difference
Cooling	27°C DB/19°C WB (81°F DB/66°F WB)	35°C DB/24°C WB (95°F DB/75°F WB)	7.5m (24-9/16ft.)	0m (0ft.)
Heating	20°C DB/68°F DB)	7°C DB/6°C WB (45°F DB/43°F WB)	7.5m (24-9/16ft.)	0m (0ft.)

\*3 -5°C DB (23°F DB) / -6°C WB (21°F WB) to 21°C DB (70°F DB) / 15.5°C WB (60°F WB) with cooling/heating mixed operation.

\*4 External static pressure option is available (30Pa, 60Pa / 3.1mmH<sub>2</sub>O, 6.1mmH<sub>2</sub>O).

\*Nominal condition \*1, \*2 are subject to JIS B8615-1.

\*Due to continuing improvement, above specification may be subject to change without notice.



# HEAT SOURCE UNIT WR2 (Heat Recovery) Series PQRY-P YHM-A



## ► Specifications

Model	PQRY-P200YHM-A		PQRY-P250YHM-A		PQRY-P300YHM-A	
Power source	3-phase 4-wire 380-400-415V 50/60Hz		3-phase 4-wire 380-400-415V 50/60Hz		3-phase 4-wire 380-400-415V 50/60Hz	
Cooling capacity (Nominal)	*1	kW	22.4		28.0	
	*1	BTU / h	76,400		95,500	
		Power input kW	3.96		5.51	
		Current input A	6.6-6.3-6.1		9.3-8.8-8.5	
		EER	5.65		5.08	
Temp. range of cooling	Indoor	W.B.	15.0~24.0°C(59~75°F)		15.0~24.0°C(59~75°F)	
	Circulating water	°C	10.0~45.0°C(50~113°F)		10.0~45.0°C(50~113°F)	
Heating capacity (Nominal)	*2	kW	25.0		31.5	
	*2	BTU / h	85,300		107,500	
		Power input kW	4.12		5.80	
		Current input A	6.9-6.6-6.3		9.7-9.3-8.9	
		COP	6.06		5.43	
Temp. range of heating	Indoor	D.B.	15.0~27.0°C(59~81°F)		15.0~27.0°C(59~81°F)	
	Circulating water	°C	10.0~45.0°C(50~113°F)		10.0~45.0°C(50~113°F)	
Indoor unit connectable	Total capacity	50~150 % of heat source unit capacity		50~150 % of heat source unit capacity		
	Model / Quantity	P15~P250 / 1~20		P15~P250 / 1~25		
Sound pressure level (measured in anechoic room)	dB <A>	47		49		
Refrigerant piping diameter [O.D.]	High pressure	15.88(5/8) Brazed		19.05(3/4) Brazed		
	Low pressure	19.05(3/4) Brazed		22.2(7/8) Brazed		
Circulating water	Water flow rate	m <sup>3</sup> / h	5.76		5.76	
		L/min	96		96	
		cfm	3.4		3.4	
	Pressure drop	kPa	17		17	
	Operating volume range	m <sup>3</sup> / h	4.5 ~ 7.2		4.5 ~ 7.2	
Compressor	Type x Quantity	Inverter scroll hermetic compressor		Inverter scroll hermetic compressor		
	Starting method	Inverter		Inverter		
	Motor output	kW		6.3		
	Case heater	kW		0.035(240 V)		
External finish	Acrylic painted steel plate		Acrylic painted steel plate		Acrylic painted steel plate	
External dimension HxWxD	mm	1,160(1,100 without legs) x 880 x 550		1,160(1,100 without legs) x 880 x 550		
	in.	45-11/16(43-5/16 without legs) x 34-11/16 x 21-11/16		45-11/16(43-5/16 without legs) x 34-11/16 x 21-11/16		
Protection devices	High pressure protection	High pressure sensor, High pressure switch at 4.15MPa (601 psi)		High pressure sensor, High pressure switch at 4.15MPa (601 psi)		
	Inverter circuit (COMP.)	Over-heat protection, Over-current protection		Over-heat protection, Over-current protection		
Refrigerant	Type x original charge	R410A x 5.0kg (12lbs)		R410A x 5.0kg (12lbs)		
	Net weight	kg (lbs)		181(400)		
Heat exchanger			plate type		plate type	
	Water volume in plate	L	5.0		5.0	
	Water pressure Max.	MPa	2.0		2.0	
Optional parts	Joint: CMY-Y102SS-G2, CMY-Y102LS-G2, CMY-Y202S-G2, CMY-R160-J1		Joint: CMY-Y102SS-G2, CMY-Y102LS-G2, CMY-Y202S-G2, CMY-R160-J1		Joint: CMY-Y102SS-G2, CMY-Y102LS-G2, CMY-Y202S-G2, CMY-R160-J1	

### Notes:

\*1,\*2 Nominal conditions

	Indoor	Water temperature	Pipe length	Level difference
Cooling	27°C D.B./19°C W.B. (81°F D.B./66°F W.B.)	30°C (86°F)	7.5m (24-9/16ft.)	0m (0ft.)
Heating	20°C D.B. (68°F D.B.)	20°C (68°F)		

\*3 The ambient temperature of the heat source unit needs to be kept below 40°C D.B.

\*4 The ambient relative humidity of the heat source unit needs to be kept below 80%.

\*5 The heat source Unit should not be installed at outdoor.

\*6 Be sure to mount a strainer (more than 50 meshes) at the water inlet piping of the unit.

\*7 Be sure to provide interlocking for the unit operation and water circuit.

\*Nominal condition \*1,\*2 are subject to JIS B8615-1.

\*Due to continuing improvement, above specification may be subject to change without notice.



# HEAT SOURCE UNIT WR2 (Heat Recovery) Series PQRY-P YSHM-A



## ► Specifications

Model		PQRY-P400YSHM-A		PQRY-P450YSHM-A		PQRY-P500YSHM-A		
Power source		3-phase 4-wire 380-400-415V 50/60Hz		3-phase 4-wire 380-400-415V 50/60Hz		3-phase 4-wire 380-400-415V 50/60Hz		
Cooling capacity (Nominal)	*1 kW	45.0		50.0		56.0		
	*1 BTU / h	153,500		170,600		191,100		
	Power input kW	8.32		9.94		11.57		
	Current input A	14.0-13.3-12.8		16.7-15.9-15.3		19.5-18.5-17.8		
Temp. range of cooling	Indoor W.B.	15.0~24.0°C(59~75°F)		15.0~24.0°C(59~75°F)		15.0~24.0°C(59~75°F)		
	Circulating water °C	10.0~45.0°C(50~113°F)		10.0~45.0°C(50~113°F)		10.0~45.0°C(50~113°F)		
Heating capacity (Nominal)	*2 kW	50.0		56.0		63.0		
	*2 BTU / h	170,600		191,100		215,000		
	Power input kW	8.65		10.42		12.06		
	Current input A	14.6-13.8-13.3		17.5-16.7-16.1		20.3-19.3-18.6		
Temp. range of heating	Indoor D.B.	15.0~27.0°C(59~81°F)		15.0~27.0°C(59~81°F)		15.0~27.0°C(59~81°F)		
	Circulating water °C	10.0~45.0°C(50~113°F)		10.0~45.0°C(50~113°F)		10.0~45.0°C(50~113°F)		
Indoor unit connectable	Total capacity	50~150 % of heat source unit capacity		50~150 % of heat source unit capacity		50~150 % of heat source unit capacity		
	Model / Quantity	P15~P250 / 1~40		P15~P250 / 1~45		P15~P250 / 1~50 (Connectable branch pipe number is max. 48.)		
Sound pressure level (measured in anechoic room)	dB <A>	50		51		52		
Refrigerant piping diameter [O.D.]	High pressure mm (in.)	22.2(7/8) Brazed		22.2(7/8) Brazed		22.2(7/8) Brazed		
	Low pressure mm (in.)	28.58(1-1/8) Brazed		28.58(1-1/8) Brazed		28.58(1-1/8) Brazed		
Set Model								
Model		PQRY-P200YHM-A		PQRY-P200YHM-A		PQRY-P250YHM-A		
Circulating water	Water flow rate	m <sup>3</sup> / h	5.76 + 5.76		5.76 + 5.76		5.76 + 5.76	
		L/min	96 + 96		96 + 96		96 + 96	
		cfm	3.4 + 3.4		3.4 + 3.4		3.4 + 3.4	
	Pressure drop	kPa	17	17	17	17	17	17
Operating volume range	m <sup>3</sup> / h	4.5 + 4.5 ~ 7.2 + 7.2		4.5 + 4.5 ~ 7.2 + 7.2		4.5 + 4.5 ~ 7.2 + 7.2		
Compressor	Type x Quantity	Inverter scroll hermetic compressor		Inverter scroll hermetic compressor		Inverter scroll hermetic compressor		
	Starting method	Inverter	Inverter	Inverter	Inverter	Inverter	Inverter	
	Motor output	kW	4.6	4.6	6.3	4.6	6.3	6.3
	Case heater	kW	0.035(240 V)	0.035(240 V)	0.035(240 V)	0.035(240 V)	0.035(240 V)	0.035(240 V)
External finish		Acrylic painted steel plate		Acrylic painted steel plate		Acrylic painted steel plate		
External dimension HxWxD	mm	1,160(1,100 without legs) x 880 x 550	1,160(1,100 without legs) x 880 x 550	1,160(1,100 without legs) x 880 x 550	1,160(1,100 without legs) x 880 x 550	1,160(1,100 without legs) x 880 x 550	1,160(1,100 without legs) x 880 x 550	
		in.	45-11/16(43-5/16 without legs) x 34-11/16 x 21-11/16	45-11/16(43-5/16 without legs) x 34-11/16 x 21-11/16	45-11/16(43-5/16 without legs) x 34-11/16 x 21-11/16	45-11/16(43-5/16 without legs) x 34-11/16 x 21-11/16	45-11/16(43-5/16 without legs) x 34-11/16 x 21-11/16	45-11/16(43-5/16 without legs) x 34-11/16 x 21-11/16
Protection devices	High pressure protection	High pressure sensor, High pressure switch at 4.15MPa (601 psi)		High pressure sensor, High pressure switch at 4.15MPa (601 psi)		High pressure sensor, High pressure switch at 4.15MPa (601 psi)		
	Inverter circuit (COMP.)	Over-heat protection, Over-current protection		Over-heat protection, Over-current protection		Over-heat protection, Over-current protection		
	Compressor	Over-heat protection		Over-heat protection		Over-heat protection		
Refrigerant	Type x original charge	R410A x 5.0kg (12lbs)	R410A x 5.0kg (12lbs)	R410A x 5.0kg (12lbs)	R410A x 5.0kg (12lbs)	R410A x 5.0kg (12lbs)	R410A x 5.0kg (12lbs)	
Net weight	kg (lbs)	181(400)	181(400)	181(400)	181(400)	181(400)	181(400)	
Heat exchanger			plate type	plate type	plate type	plate type	plate type	
	Water volume in plate	L	5.0	5.0	5.0	5.0	5.0	
	Water pressure Max.	MPa	2.0	2.0	2.0	2.0	2.0	
Optional parts			Heat Source Twinning kit: CMY-Q100VBK Joint: CMY-Y102SS-G2, CMY-Y102LS-G2, CMY-Y202S-G2, CMY-R160-J1	Heat Source Twinning kit: CMY-Q100VBK Joint: CMY-Y102SS-G2, CMY-Y102LS-G2, CMY-Y202S-G2, CMY-R160-J1	Heat Source Twinning kit: CMY-Q100VBK Joint: CMY-Y102SS-G2, CMY-Y102LS-G2, CMY-Y202S-G2, CMY-R160-J1	Heat Source Twinning kit: CMY-Q100VBK Joint: CMY-Y102SS-G2, CMY-Y102LS-G2, CMY-Y202S-G2, CMY-R160-J1	Heat Source Twinning kit: CMY-Q100VBK Joint: CMY-Y102SS-G2, CMY-Y102LS-G2, CMY-Y202S-G2, CMY-R160-J1	

### Notes:

\*1, \*2 Nominal conditions

	Indoor	Water temperature	Pipe length	Level difference
Cooling	27°C D.B./19°C W.B. (81°F D.B./66°F W.B.)	30°C (86°F)	7.5m (24-9/16ft.)	0m (0ft.)
Heating	20°C D.B. (68°F D.B.)	20°C (68°F)		

\*3 The ambient temperature of the heat source unit needs to be kept below 40°C D.B.

\*4 The ambient relative humidity of the heat source unit needs to be kept below 80%.

\*5 The heat source Unit should not be installed at outdoor.

\*6 Be sure to mount a strainer (more than 50 meshes) at the water inlet piping of the unit.

\*7 Be sure to provide interlocking for the unit operation and water circuit.

\*Nominal condition \*1, \*2 are subject to JIS B8615-1.

\*Due to continuing improvement, above specification may be subject to change without notice.

### Outdoor Unit

# HEAT SOURCE UNIT WR2 (Heat Recovery) Series PQRY-P YSHM-A



## ► Specifications

Model			PQRY-P550YSHM-A		PQRY-P600YSHM-A	
Power source			3-phase 4-wire 380-400-415V 50/60Hz		3-phase 4-wire 380-400-415V 50/60Hz	
Cooling capacity (Nominal)	*1	kW	63.0		69.0	
	*1	BTU / h	215,000		235,400	
		Power input kW	13.60		15.62	
		Current input A	22.9-21.8-21.0		26.3-25.0-24.1	
		EER kW / kW	4.63		4.41	
Temp. range of cooling	Indoor	W.B.	15.0~24.0°C(59~75°F)		15.0~24.0°C(59~75°F)	
	Circulating water	°C	10.0~45.0°C(50~113°F)		10.0~45.0°C(50~113°F)	
Heating capacity (Nominal)	*2	kW	69.0		76.5	
	*2	BTU / h	235,400		261,000	
		Power input kW	14.65		17.12	
		Current input A	24.7-23.4-22.6		28.9-27.4-26.4	
		COP kW / kW	4.70		4.46	
Temp. range of heating	Indoor	D.B.	15.0~27.0°C(59~81°F)		15.0~27.0°C(59~81°F)	
	Circulating water	°C	10.0~45.0°C(50~113°F)		10.0~45.0°C(50~113°F)	
Indoor unit connectable	Total capacity		50~150 % of heat source unit capacity		50~150 % of heat source unit capacity	
	Model / Quantity		P15~P250 / 2~50 (Connectable branch pipe number is max. 48.)		P15~P250 / 2~50 (Connectable branch pipe number is max. 48.)	
Sound pressure level (measured in anechoic room)		dB <A>	52.5		53	
Refrigerant piping diameter [O.D.]	High pressure	mm (in.)	28.58(1-1/8) Brazed		28.58(1-1/8) Brazed	
	Low pressure	mm (in.)	28.58(1-1/8) Brazed		28.58(1-1/8) Brazed	
Set Model						
Model			PQRY-P300YHM-A		PQRY-P250YHM-A	
Circulating water	Water flow rate	m <sup>3</sup> / h	5.76 + 5.76		5.76 + 5.76	
		L/min	96 + 96		96 + 96	
		cfm	3.4 + 3.4		3.4 + 3.4	
	Pressure drop	kPa	17		17	
	Operating volume range	m <sup>3</sup> / h	4.5 + 4.5 ~ 7.2 + 7.2		4.5 + 4.5 ~ 7.2 + 7.2	
Compressor	Type x Quantity		Inverter scroll hermetic compressor		Inverter scroll hermetic compressor	
	Starting method		Inverter		Inverter	
	Motor output	kW	7.4		7.4	
	Case heater	kW	0.035(240 V)		0.035(240 V)	
External finish		Acrylic painted steel plate				
External dimension HxWxD	mm		1,160(1,100 without legs) x 880 x 550		1,160(1,100 without legs) x 880 x 550	
		in.	45-11/16(43-5/16 without legs) x 34-11/16 x 21-11/16		45-11/16(43-5/16 without legs) x 34-11/16 x 21-11/16	
Protection devices	High pressure protection		High pressure sensor, High pressure switch at 4.15MPa (601 psi)		High pressure sensor, High pressure switch at 4.15MPa (601 psi)	
	Inverter circuit (COMP.)		Over-heat protection, Over-current protection		Over-heat protection, Over-current protection	
	Compressor		Over-heat protection		Over-heat protection	
Refrigerant	Type x original charge		R410A x 5.0kg (12lbs)		R410A x 5.0kg (12lbs)	
Net weight		kg (lbs)	181(400)		181(400)	
Heat exchanger			plate type		plate type	
	Water volume in plate	L	5.0		5.0	
	Water pressure Max.	MPa	2.0		2.0	
Optional parts	Heat Source Twinning kit: CMY-Q100VBK Joint: CMY-Y102SS-G2,CMY-Y102LS-G2,CMY-Y202S-G2,CMY-R160-J1				Heat Source Twinning kit: CMY-Q100VBK Joint: CMY-Y102SS-G2,CMY-Y102LS-G2,CMY-Y202S-G2,CMY-R160-J1	

### Notes:

\*1,\*2 Nominal conditions

	Indoor	Water temperature	Pipe length	Level difference
Cooling	27°C D.B./19°C W.B. (81°F D.B./66°F W.B.)	30°C (86°F)	7.5m (24-9/16ft.)	0m (0ft.)
Heating	20°C D.B. (68°F D.B.)	20°C (68°F)		

\*3 The ambient temperature of the heat source unit needs to be kept below 40°C D.B.

\*4 The ambient relative humidity of the heat source unit needs to be kept below 80%.

\*5 The heat source Unit should not be installed at outdoor.

\*6 Be sure to mount a strainer (more than 50 meshes) at the water inlet piping of the unit.

\*7 Be sure to provide interlocking for the unit operation and water circuit.

\*Nominal condition \*1,\*2 are subject to JIS B8615-1.

\*Due to continuing improvement, above specification may be subject to change without notice.

















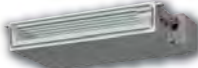



# I ndoor Unit

- **Ceiling cassette type 4-way airflow**
- **Ceiling cassette type 2-way airflow**
- **Ceiling cassette type 1-way airflow**
- **Ceiling concealed type**
- **Fresh Air Intake type**
- **Ceiling suspended type**
- **Wall mounted type**
- **Floor standing exposed**
- **Floor mounted concealed type**
- **BC Controller**
- **Air to Water unit**
-  **Logsnay**
- **OA Processing Units**

# Wide Selection of Indoor Units

Type		Model name	Model	P15	P20	P25
Ceiling Cassette	4-way air flow	<b>PLFY-P VBM-E</b> Page80 - Page81				
		<b>PLFY-P VCM-E2</b> Page80 - Page81				
	2-way air flow	<b>PLFY-P VLMD-E</b> Page82 - Page83				
	1-way air flow	<b>PMFY-P VBM-E</b> Page84 - Page85				
Ceiling Concealed		<b>PEFY-P VMR-E-L/R</b> Page86 - Page87				
		<b>PEFY-P VMS1(L)-E</b> Page88 - Page89				
		<b>PEFY-P VMA(L)-E</b> Page90 - Page91				
		<b>PEFY-P VMH(S)-E</b> Page92 - Page93				
	Fresh Air Intake	<b>PEFY-P VMH-E-F</b> Page94 - Page95				
Ceiling Suspended	<b>PCFY-P VKM-E</b> Page96 - Page97					
Wall Mounted		<b>PKFY-P VBM-E</b> Page98 - Page99				
		<b>PKFY-P VHM-E</b> Page98 - Page99				
		<b>PKFY-P VKM-E</b> Page98 - Page99				
Floor Standing/ Floor Mounted Concealed		<b>PFFY-P VKM-E2</b> Page100 - Page101				
		<b>PFFY-P VLEM-E</b> Page102 - Page103				
		<b>PFFY-P VLRM-E</b> <b>PFFY-P VLRMM-E</b> Page104 - Page105				

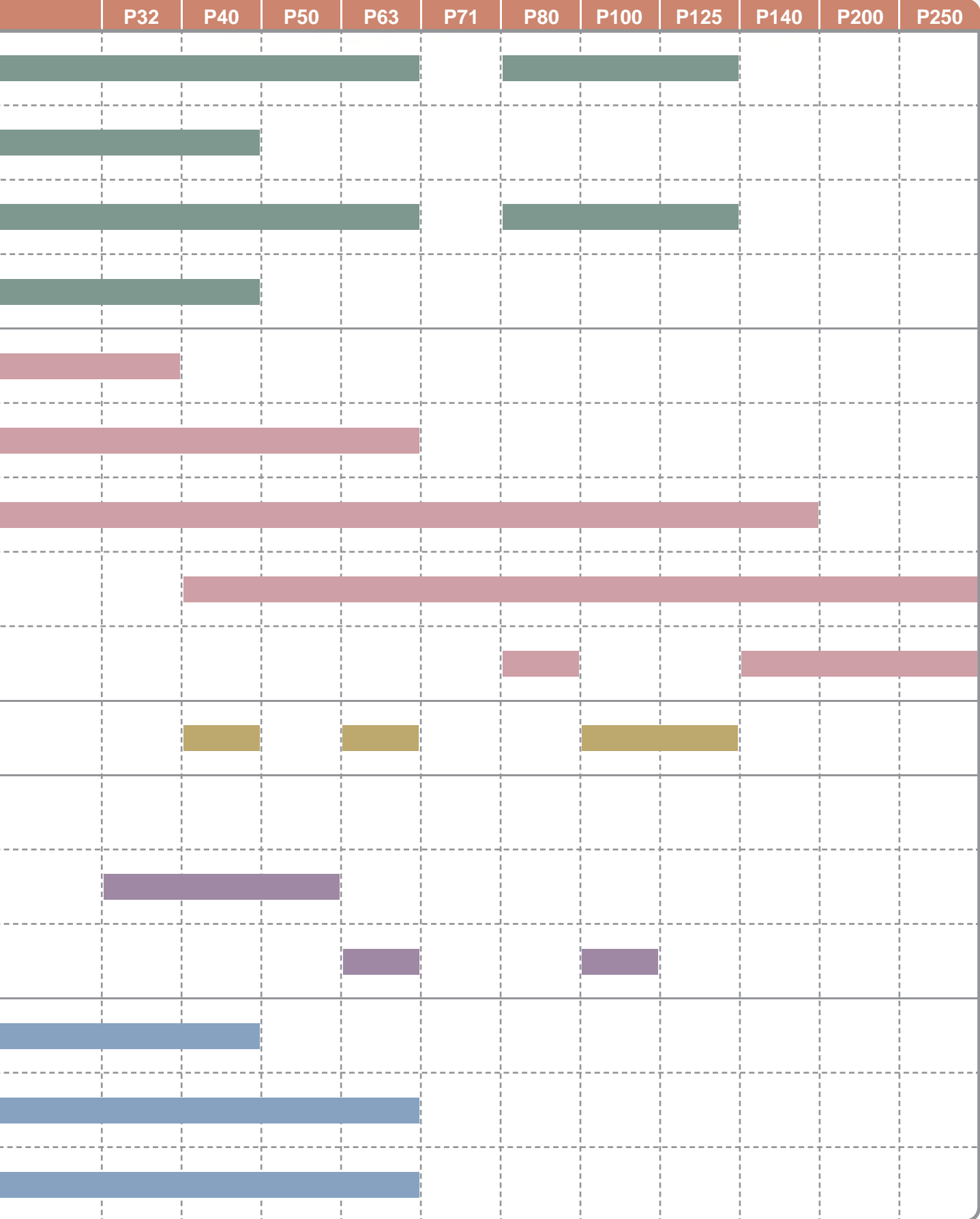

# INDOOR UNIT

## Ceiling cassette type

### 4-way airflow

PLFY-P VBM-E *i-see Sensor*  
 PLY-P VCM-E2



PLY-P VBM



PLY-P VCM

The 4-way cassette VBM offers 72 different airflow patterns, making it ideal for applications with ceilings up to 4.2 m (13-13/16ft) in height.



Compact body to match with 2 feet (600mm) x 2 feet (600mm) ceiling design (VCM)

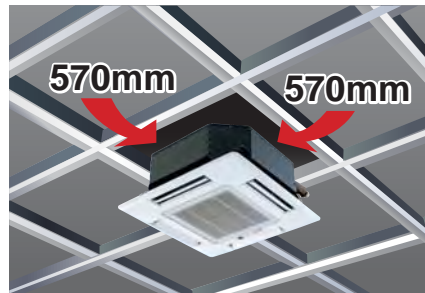

#### Automatic Air Speed Adjustment

Auto-fan-speed mode enables speedy and comfortable heating during heating startup.

The Auto-fan-speed mode is added to the usual four steps "Low, Mid1, Mid2, High." The Auto-fan-speed mode enables speedy and comfortable air conditioning due to the air flow when starting and slows down when the air conditioning becomes stable. (PLFY-P VBM-E ONLY)



\* When using a wireless remote controller, initial settings are required.

#### Draft-less Air Distribution

The horizontal air flow prevents exposure of cooled/warmed air directly at occupants, creating a comfortable environment.

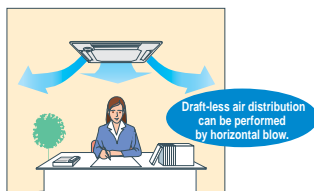

\*The ceiling may be smudged at a spot where the supplied airflow is seriously disturbed.

#### Wide Air Flow (PLFY-P VBM-E ONLY)

##### Cooling softly with Wide Air Flow

Discharge air reaches wider area and the fan speed is decreased by 20% thanks to the new wide shape air outlet.



72 patterns of airflow to accommodate any room layout are available.

First in the industry

\*On the commercial air conditioners (According to the survey by Mitsubishi Electric)

The number of outlet can be set to 4, 3, or 2. Flexible airflow is available by fixing the up-down airflow direction of the outlet with a wired remote controller (or manually).

#### 72 airflow patterns

##### 4-, 3-, or 2- way outlet selection\*

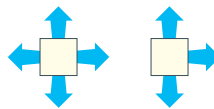

\* Optional parts air outlet shutter plate (PLFY-P VBM-E ONLY) is required for 2 or 3 way outlet selection.

#### Setting the air direction for each outlet with wired remote controller

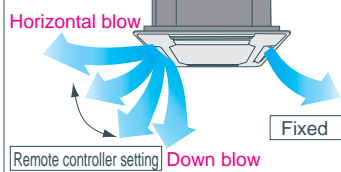

"i-see sensor" can be used with ceiling cassette type 4-way airflow unit. (Option PAC-SA1ME-E, PLY-P VBM-E ONLY)

New 4-way Cassette PLY-P VBM controls the temperature difference at the top and bottom in a room by checking the floor temperature with "i-see sensor". Comfortable air conditioning can be realized smoothly with "sensible temperature control." (Option PAC-SA1ME-E, PLY-P VBM-E ONLY)

#### Prevents overcooling/overheating, and improves comfort/energy-efficiency

Without i-see sensor: preset temperature at 23°C

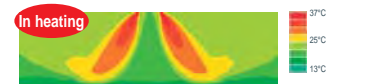

Feeling temperature at 20°C (Bottom 17°C)

Preset temperature is tended to be higher than we need, because heated air rises to the ceiling.

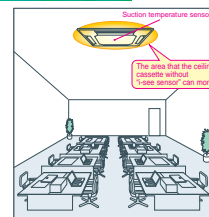

With i-see sensor+Auto fan speed: preset temperature at 20°C



Feeling temperature at 20°C (Bottom 20°C)

Auto-fan-speed mode of 4-way Cassette with "i-see sensor" heats the floor well and decreases the temperature difference at the top and bottom in a room.

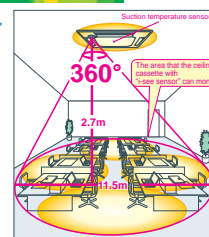



## ► Specifications

		PLFY-P20VBM-E	PLFY-P25VBM-E	PLFY-P32VBM-E	PLFY-P40VBM-E	PLFY-P50VBM-E	PLFY-P63VBM-E	PLFY-P80VBM-E	
Power source		1-phase 220-240V 50Hz / 1-phase 220V 60Hz							
Cooling capacity	*1 kW	2.2	2.8	3.6	4.5	5.6	7.1	9.0	
	*1 BTU/h	7,500	9,600	12,300	15,400	19,100	24,200	30,700	
Heating capacity	*1 kW	2.5	3.2	4.0	5.0	6.3	8.0	10.0	
	*1 BTU/h	8,500	10,900	13,600	17,100	21,500	27,300	34,100	
Power consumption	Cooling kW	0.03	0.03	0.03	0.04	0.04	0.05	0.07	
	Heating kW	0.02	0.02	0.02	0.03	0.03	0.04	0.06	
Current	Cooling A	0.26	0.26	0.27	0.29	0.29	0.36	0.51	
	Heating A	0.19	0.19	0.20	0.22	0.22	0.29	0.43	
External finish (Munsell No.)	Unit	Galvanized steel sheet							
	Panel	MUNSELL (6.4Y 8.9/0.4)							
Dimension H x W x D	Unit mm(in.)	258 x 840 x 840 (10-3/16 x 33-1/8 x 33-1/8)							
	Panel mm(in.)	35 x 950 x 950 (1-3/8 x 37-7/16 x 37-7/16)							
Net weight	Unit kg(lbs.)	22 (49)					23 (51)		
	Panel kg(lbs.)	6 (13)							
Heat exchanger		Cross fin (Aluminum fin and copper tube)							
Fan	Type x Quantity	Turbo fan x 1							
	Airflow rate *2 (Lo-Mid1-Mid2-Hi)	m <sup>3</sup> /min	11-12-13-14			12-13-14-16		14-15-16-18	16-18-20-22
		L/s	183-200-217-233			200-217-233-267		233-250-267-300	267-300-333-367
	External static pressure	cfm	388-424-459-494			424-459-494-565		494-530-565-636	565-636-706-777
Motor	Type	DC motor							
	Output kW	0.050							
Air filter		PP Honeycomb							
Refrigerant pipe diameter	Gas (Flare) mm(in.)	ø12.7 (ø1/2)				ø12.7 (ø1/2) / ø15.88 (ø5/8) (Compatible)		ø15.88(ø5/8)	
	Liquid (Flare) mm(in.)	ø6.35 (ø1/4)				ø6.35 (ø1/4) / ø9.52 (ø3/8) (Compatible)		ø9.52 (ø3/8)	
Field drain pipe diameter		mm(in.) O.D. 32 (1-1/4)							
Sound pressure level *2 *3 (Lo-Mid1-Mid2-Hi)	dB(A)	27-28-29-31			27-28-30-31		28-29-30-32	30-32-35-37	

		PLFY-P100VBM-E	PLFY-P125VBM-E	PLFY-P15VCM-E2	PLFY-P20VCM-E2	PLFY-P25VCM-E2	PLFY-P32VCM-E2	PLFY-P40VCM-E2	
Power source		1-phase 220-240V 50Hz / 1-phase 220V 60Hz			1-phase 220-240V 50Hz				
Cooling capacity	*1 kW	11.2	14.0	1.7	2.2	2.8	3.6	4.5	
	*1 BTU/h	38,200	47,800	5,800	7,500	9,600	12,300	15,400	
Heating capacity	*1 kW	12.5	16.0	1.9	2.5	3.2	4.0	5.0	
	*1 BTU/h	42,700	54,600	6,500	8,500	10,900	13,600	17,100	
Power consumption	Cooling kW	0.15	0.16	0.04	0.05	0.05	0.06	0.06	
	Heating kW	0.14	0.15	0.04	0.05	0.05	0.06	0.06	
Current	Cooling A	1.00	1.07	0.19	0.23	0.23	0.28	0.28	
	Heating A	0.94	1.00	0.19	0.23	0.23	0.28	0.28	
External finish (Munsell No.)	Unit	Galvanized steel sheet			Galvanized steel sheet with gray heat insulation				
	Panel	MUNSELL (6.4Y 8.9/0.4)			MUNSELL (6.4Y 8.9/0.4)				
Dimension H x W x D	Unit mm(in.)	298 x 840 x 840 (11-3/4 x 33-1/8 x 33-1/8)			208 x 570 x 570 (8-1/4 x 22-1/2 x 22-1/2)				
	Panel mm(in.)	35 x 950 x 950 (1-3/8 x 37-7/16 x 37-7/16)			20 x 650 x 650 (13/16 x 25-5/8 x 25-5/8)				
Net weight	Unit kg(lbs.)	27 (60)			15.5 (35)		17 (38)		
	Panel kg(lbs.)	6 (13)			3 (7)				
Heat exchanger		Cross fin (Aluminum fin and copper tube)							
Fan	Type x Quantity	Turbo fan x 1							
	Airflow rate *2 (Lo-Mid-Hi)	m <sup>3</sup> /min	21-24-27-29	22-25-28-30	8-8.5-9	8-9-10	8-9-10	8-9-11	8-9-11
		L/s	350-400-450-483	367-417-467-500	133-142-150	133-150-167	133-150-167	133-150-183	133-150-183
	External static pressure	cfm	742-848-953-1024	777-883-989-1059	283-300-353	283-318-353	283-318-353	283-318-388	283-318-388
Pa		0							
Motor	Type	DC motor			1-phase induction motor				
	Output kW	0.120			0.008	0.011	0.015	0.02	0.02
Air filter		PP Honeycomb fabric (long life type)							
Refrigerant pipe diameter	Gas (Flare) mm(in.)	ø15.88 (ø5/8) / ø19.05 (ø3/4) (Compatible)			ø12.7 (ø1/2)				
	Liquid (Flare) mm(in.)	ø9.52 (ø3/8)			ø6.35 (ø1/4)				
Field drain pipe diameter		mm(in.) O.D. 32 (1-1/4)			mm(in.) O.D. 32 (1-1/4) (PVC pipe VP-25 connectable)				
Sound pressure level *2 *3 (Lo-Mid1-Mid2-Hi)	dB(A)	34-37-39-41	35-38-41-43	28-30-31	28-31-35	29-31-37	29-33-38	30-34-39	

### Notes:

\*1 Cooling/Heating capacity indicates the maximum value at operation under the following condition.

Cooling : Indoor 27°C(81°F)DB/19°C(66°F)WB, Outdoor 35°C(95°F)DB  
 Heating : Indoor 20°C(68°F)DB, Outdoor 7°C(45°F)DB/6°C(43°F)WB

\*2 Airflow rate/Sound pressure level are in (Lo-Mid-Hi) or (Lo-Mid1-Mid2-Hi).

\*3 It is measured in anechoic room at power source 230V.

# INDOOR UNIT

## Ceiling cassette type

### 2-way airflow

#### PLFY-P VLMD-E



### Slim body of 290mm(11-7/16in.) height



#### Equipped with drain pump mechanism as standard

The drain can be positioned anywhere up to 583mm(22-15/16in.) from the ceiling's surface, providing greater freedom with long cross-piping and allowing more versatility with piping layouts.

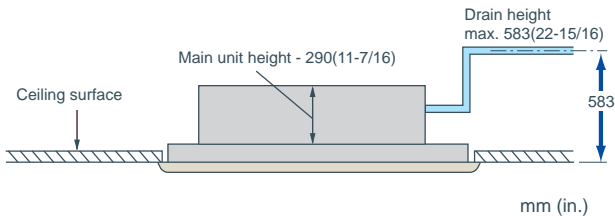

#### Slim body - only 290mm(11-7/16in.) height

The slimline body is suitable for installation in narrow ceiling spaces and for replacing obsolete air-conditioning equipment in older buildings. The main unit is only 290mm(11-7/16in.) height.

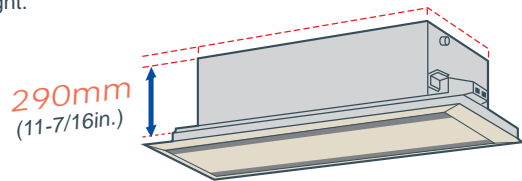

#### Terminal block on outside of main unit makes wiring easier

#### Compact unit and low noise level attained!

Sound pressure level table (Standard static pressure) at 0Pa

Sound pressure Level	Capacity		dB(A)								
	Fan Speed	High	P20	P25	P32	P40	P50	P63	P80	P100	P125
		Mid	Low								
	High	33			36	37	39	39	42	46	
	Mid	30			33	34	37	36	39	42/44	
	Low	27			29	31	32	33	36	40	

<220V,240V>

Sound pressure Level	Capacity		dB(A)								
	Fan Speed	High	P20	P25	P32	P40	P50	P63	P80	P100	P125
		Mid	Low								
	High	34			37	38	40	40	43	46	
	Mid	31			34	35	38	37	41	42/44	
	Low	28			30	32	33	34	37	40	

<230V>

#### Fresh air directly taken in

Fresh air can be taken in to the main unit directly (optional accessories needed.)

#### Long life filter equipped as standard

The antibacterial long life filter does not require maintenance for approximately a year.

#### Easy installation

Lighter panel and placing the electric board near the panel make installation and maintenance easier. Also, the heat exchanger is washable by displacing the center panel, filter, and fan.

## ► Specifications

		PLFY-P20VLM-D-E	PLFY-P25VLM-D-E	PLFY-P32VLM-D-E	PLFY-P40VLM-D-E	
Power source		1-phase 220-240V 50Hz / 1-phase 220-230V 60Hz				
Cooling capacity	*1 kW	2.2	2.8	3.6	4.5	
	*1 BTU/h	7,500	9,600	12,300	15,400	
Heating capacity	*1 kW	2.5	3.2	4.0	5.0	
	*1 BTU/h	8,500	10,900	13,600	17,100	
Power consumption	Cooling kW	0.072 / 0.075	0.072 / 0.075	0.072 / 0.075	0.081 / 0.085	
	Heating kW	0.065 / 0.069	0.065 / 0.069	0.065 / 0.069	0.074 / 0.079	
Current	Cooling A	0.36 / 0.37	0.36 / 0.37	0.36 / 0.37	0.40 / 0.42	
	Heating A	0.30 / 0.32	0.30 / 0.32	0.30 / 0.32	0.34 / 0.37	
External finish (Munsell No.)	Unit	Galvanized steel plate				
	Panel	Pure white (6.4Y 8.9/0.4)				
Dimension H x W x D	Unit mm (in.)	290 x 776 x 634 (11-7/16 x 30-9/16 x 25)				
	Panel mm (in.)	20 x 1080 x 710 (13/16 x 42-9/16 x 28)				
Net weight	Unit kg(lbs.)	23 (51)		24 (53)		
	Panel kg(lbs.)	6.5 (15)				
Heat exchanger		Cross fin				
Fan	Type x Quantity	Turbo fan x 1				
	Airflow rate *2 (Lo-Mid-Hi)	m <sup>3</sup> /min	6.5-8.0-9.5		7.0-8.5-10.5	
		L/s	108-133-158		117-142-175	
	External static pressure	cfm	230-283-335		247-300-371	
	Pa	0				
Motor	Type	1-phase induction motor				
	Output kW	0.015 (at 240V)				
Air filter		PP honeycomb fabric (long life type)				
Refrigerant pipe diameter	Gas(Flare) mm(in.)	ø12.7 (ø1/2)				
	Liquid(Flare) mm(in.)	ø6.35 (ø1/4)				
Field drain pipe diameter		mm(in.) O.D.32 (1-1/4)				
Sound pressure level (Lo-Mid-Hi) *2 *3	220V,240V dB(A)	27-30-33			29-33-36	
	230V dB(A)	28-31-34			30-34-37	

		PLFY-P50VLM-D-E	PLFY-P63VLM-D-E	PLFY-P80VLM-D-E	PLFY-P100VLM-D-E	PLFY-P125VLM-D-E	
Power source		1-phase 220-240V 50Hz / 1-phase 220-230V 60Hz					
Cooling capacity	*1 kW	5.6	7.1	9.0	11.2	14.0	
	*1 BTU/h	19,100	24,200	30,700	38,200	47,800	
Heating capacity	*1 kW	6.3	8.0	10.0	12.5	16.0	
	*1 BTU/h	21,500	27,300	34,100	42,700	54,600	
Power consumption	Cooling kW	0.082 / 0.086	0.101 / 0.105	0.147 / 0.156	0.157 / 0.186	0.28 / 0.28	
	Heating kW	0.075 / 0.080	0.094 / 0.099	0.140 / 0.150	0.150 / 0.180	0.27 / 0.27	
Current	Cooling A	0.41 / 0.43	0.49 / 0.51	0.72 / 0.74	0.75 / 0.88	1.35 / 1.35	
	Heating A	0.35 / 0.38	0.43 / 0.46	0.66 / 0.69	0.69 / 0.83	1.33 / 1.33	
External finish (Munsell No.)	Unit	Galvanized steel plate					
	Panel	Pure white (6.4Y 8.9 / 0.4)					
Dimension H x W x D	Unit mm (in.)	290 x 946 x 634 (11-7/16 x 37-1/4 x 25)	290 x 1446 x 634 (11-7/16 x 56-15/16 x 25)		290 x 1708 x 606 (11-7/16 x 67-1/4 x 23-7/8)		
	Panel mm (in.)	20 x 1250 x 710 (13/16 x 49-1/4 x 28)	20 x 1750 x 710 (13/16 x 68-15/16 x 28)		20 x 2010 x 710 (13/16 x 79-3/16 x 28)		
Net weight	Unit kg(lbs.)	27 (60)	28 (62)	44 (98)	47 (104)	56 (124)	
	Panel kg(lbs.)	7.5 (17)		12.5 (28)		13.0 (29)	
Heat exchanger		Cross fin					
Fan	Type x Quantity	Turbo fan x 1		Turbo fan x 2		Sirocco fan x 4	
	Airflow rate *2 (P50-P100:Lo-Mid-Hi) (P125:Lo-Mid2-Mid1-Hi)	m <sup>3</sup> /min	9.0-11.0-12.5	11.0-13.0-15.5	15.5-18.5-22.0	17.5-21.0-25.0	24.0-27.0-30.0-33.0
		L/s	150-183-208	167-217-258	258-308-367	292-350-417	400-450-500-550
	External static pressure	cfm	318-388-441	353-459-547	547-653-777	618-742-883	848-953-1,059-1,165
	Pa	0					
Motor	Type	1-phase induction motor					
	Output kW	0.020 (at 240V)		0.020 (at 240V)	0.030 (at 240V)	0.078 x 2 (at 240V)	
Air filter		PP honeycomb fabric (long life type)				Synthetic fiber unwoven cloth filter (long life)	
Refrigerant pipe diameter	Gas (Flare) mm(in.)	ø12.7 (ø1/2)	ø15.88 (ø5/8)				
	Liquid (Flare) mm(in.)	ø6.35 (ø1/4)	ø9.52 (ø3/8)				
Field drain pipe diameter		mm(in.) O.D.32 (1-1/4)					
Sound pressure level (Lo-Mid-Hi) *2 *3	220V,240V dB(A)	31-34-37	32-37-39	33-36-39	36-39-42	40-42-44-46	
	230V dB(A)	32-35-38	33-38-40	34-37-40	37-41-43	(Lo-Mid2-Mid1-Hi)	

### Notes:

\*1 Cooling/Heating capacity indicates the maximum value at operation under the following condition.  
Cooling : Indoor 27°C(81°F)DB/19°C(66°F)WB, Outdoor 35°C(95°F)DB  
Heating : Indoor 20°C(68°F)DB, Outdoor 7°C(45°F)DB/6°C(43°F)WB

\*2 Airflow rate/Sound pressure level are in (low-middle-high) or (low-middle2-middle1-high).

\*3 It is measured in anechoic room.

# INDOOR UNIT

## Ceiling cassette type

### 1-way airflow

### PMFY-P VBM-E



Compact and lightweight body perfect for limited ceiling space applications.



#### Compact size for smooth installation and maintenance

Unit body size has been standardised for all models at 812mm for easier installation. Body weight is only 14kg for the main unit and 3kg for the panel, making this unit one of the lightest in the industry.

#### Quiet operation

Airflow control technology reduces noise level to only 27dB (P20VBM) for quiet performance.

Sound pressure level table

Sound pressure level	Capacity		P20	P25	P32	P40
	Fan Speed					
	High		35	37	39	
	Mid 1		33	36	37	
	Mid 2		30	34	35	
	Low		27	32	33	

<220V,240V>

#### Drain pump

The drain can be positioned anywhere up to 600mm(23-5/8in.) from the ceiling's surface.

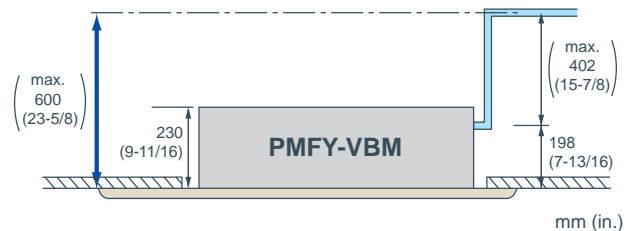

## ► Specifications

			PMFY-P20VBM-E	PMFY-P25VBM-E	PMFY-P32VBM-E	PMFY-P40VBM-E
Power source			1-phase 220-240V 50Hz / 1-phase 220V 60Hz			
Cooling capacity	*1	kW	2.2	2.8	3.6	4.5
	*1	BTU/h	7,500	9,600	12,300	15,400
Heating capacity	*1	kW	2.5	3.2	4.0	5.0
	*1	BTU/h	8,500	10,900	13,600	17,100
Power consumption	Cooling	kW	0.044			0.054
	Heating	kW	0.044			0.054
Current	Cooling	A	0.21			0.26
	Heating	A	0.21			0.26
External finish (Munsell No.)			White (0.98Y 8.99/0.63)			
Dimension	Unit	mm(in.)	230 x 812 x 395 (9-1/16 x 32 x 15-9/16)			
	Panel	mm(in.)	30 x 1000 x 470 (1-3/16 x 39-3/8 x 18-9/16)			
Net weight	Unit	kg(lbs.)	14 (31)			
	Panel	kg(lbs.)	3 (7)			
Heat exchanger			Cross fin (Aluminum plate fin and copper tube)			
Fan	Type		Line flow fan x 1			
	Airflow rate (Lo-Mid2-Mid1-Hi)	*2	m <sup>3</sup> /min	6.5-7.2-8.0-8.7	7.3-8.0-8.6-9.3	7.7-8.7-9.7-10.7
			L/s	108-120-133-145	122-133-143-155	128-145-162-178
		cfm	230-254-283-307	258-283-304-328	272-307-343-378	
	External static pressure	Pa	0			
Motor	Type		1-phase induction motor			
	Output	kW	0.028			
Air filter			PP Honeycomb fabric			
Refrigerant pipe diameter	Gas(Flare)	mm(in.)	ø12.7 (ø1/2)			
	Liquid(Flare)	mm(in.)	ø6.35 (ø1/4)			
Field drain pipe diameter			mm(in.) O.D. 26 (1)			
Sound pressure level (Lo-Mid2-Mid1-Hi) *2 *3			dB(A)	27-30-33-35	32-34-36-37	33-35-37-39

### Notes:

- \*1 Cooling/Heating capacity indicates the maximum value at operation under the following condition.  
Cooling : Indoor 27°C(81°F)DB/19°C(66°F)WB, Outdoor 35°C(95°F)DB  
Heating : Indoor 20°C(68°F)DB, Outdoor 7°C(45°F)DB/6°C(43°F)WB
- \*2 Airflow rate/Sound pressure level are in (low-middle2-middle1-high).
- \*3 It is measured in anechoic room.



# INDOOR UNIT

## Ceiling concealed type

### PEFY-P VMR-E-L/R

Static Pressure <b>5Pa</b>	Width <b>640mm</b> <small>25-6/32in.</small>	Ultra Low Noise	Piping connection L model R model
-------------------------------	--	--------------------	---



**Problem solver for residential hotels, museums, libraries, or hospitals where low noise is a must!**

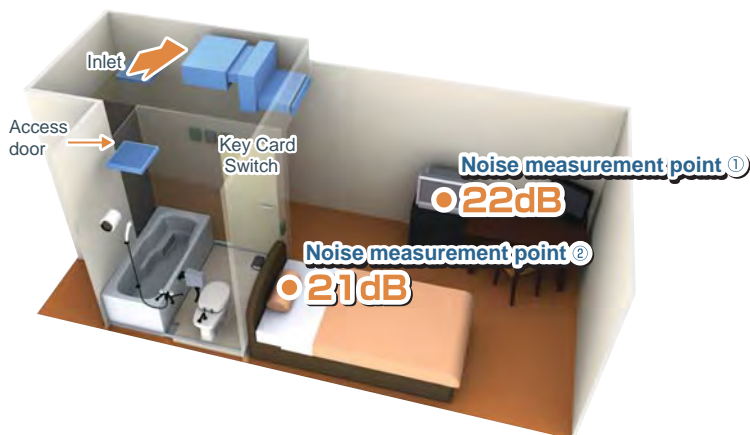

#### Operable by key card switch

It is possible to operate / stop by taking a key card in and out.

#### Ultra low noise

Quiet indoor environment can be achieved with 21dB around the bed and 22dB around the desk.

\*The noise level may differ by the room size or the setting of the unit.

#### Enables to install for symmetric design room

Left or right piping and control boxes are available depending on the layout of each room. Plus, as in the above figure, easy maintenance is possible from the access door in the bathroom.

\*Seen from the front, the pipe and control box are on the right side for -R models.

#### Energy efficiency

Energy efficiency can be realised with a centralised system when no one is in the room.

Note: Compact and simple controllers, designed specifically to control only start/stop, fan speed and temperature can be set in each room for the occupants' enhanced individual comfort.

#### Easy maintenance

Drain pan and heat exchangers are washable from the access door in the bathroom, making maintenance easy and cost saving.

## ► Specifications

			PEFY-P20VMR-E-L	PEFY-P25VMR-E-L	PEFY-P32VMR-E-L
Power source			1-phase 220-230-240V 50Hz / 1-phase 220-230V 60Hz		
Cooling capacity	*1	kW	2.2	2.8	3.6
	*1	BTU/h	7,500	9,600	12,300
Heating capacity	*1	kW	2.5	3.2	4.0
	*1	BTU/h	8,500	10,900	13,600
Power consumption	Cooling	kW	0.06 / 0.06	0.06 / 0.06	0.07 / 0.08
	Heating	kW	0.06 / 0.06	0.06 / 0.06	0.07 / 0.08
Current	Cooling	A	0.29 / 0.29	0.29 / 0.29	0.34 / 0.38
	Heating	A	0.29 / 0.29	0.29 / 0.29	0.34 / 0.38
External finish			Galvanized		
Dimension H x W x D	Rear inlet	mm (in.)	292 x 640 x 580 (11-1/2 x 25-1/4 x 22-7/8)		
	Bottom inlet	mm (in.)	300 x 640 x 570 (11-7/8 x 25-1/4 x 22-1/2)		
Net weight			18 (40)		
Heat exchanger			Cross fin (Aluminum fin and copper tube)		
Fan	Type x Quantity		Sirocco fan x 1		
	Airflow rate (Lo-Mid-Hi)	m <sup>3</sup> /min	4.8-5.8-7.9		4.8-5.8-9.3
		L/s	80-97-132		80-97-155
		cfm	170-205-279		170-205-328
External static pressure	*2 Pa	5			
Motor	Type	1-phase induction motor			
	Output	kW	0.018	0.023	
Air filter			PP Honeycomb fabric (washable)		
Refrigerant pipe diameter	Gas	mm(in.)	ø12.7 (ø1/2) Brazed		
	Liquid	mm(in.)	ø6.35 (ø1/4) Brazed		
Field drain pipe diameter			O.D. 26 (1)		
Sound pressure level (Lo-Mid-Hi)	220V	dB(A)	20-25-30		20-25-33
	230V		21-26-32		21-26-35
	240V		22-27-30		22-27-33

			PEFY-P20VMR-E-R	PEFY-P25VMR-E-R	PEFY-P32VMR-E-R
Power source			1-phase 220-230-240V 50Hz / 1-phase 220-230V 60Hz		
Cooling capacity	*1	kW	2.2	2.8	3.6
	*1	BTU/h	7,500	9,600	12,300
Heating capacity	*1	kW	2.5	3.2	4.0
	*1	BTU/h	8,500	10,900	13,600
Power consumption	Cooling	kW	0.06 / 0.06	0.06 / 0.06	0.07 / 0.08
	Heating	kW	0.06 / 0.06	0.06 / 0.06	0.07 / 0.08
Current	Cooling	A	0.29 / 0.29	0.29 / 0.29	0.34 / 0.38
	Heating	A	0.29 / 0.29	0.29 / 0.29	0.34 / 0.38
External finish			Galvanized		
Dimension H x W x D	Rear inlet	mm (in.)	292 x 640 x 580 (11-1/2 x 25-1/4 x 22-7/8)		
	Bottom inlet	mm (in.)	300 x 640 x 570 (11-7/8 x 25-1/4 x 22-1/2)		
Net weight			18 (40)		
Heat exchanger			Cross fin (Aluminum fin and copper tube)		
Fan	Type x Quantity		Sirocco fan x 1		
	Airflow rate (Lo-Mid-Hi)	m <sup>3</sup> /min	4.8-5.8-7.9		4.8-5.8-9.3
		L/s	80-97-132		80-97-155
		cfm	170-205-279		170-205-328
External static pressure	*2 Pa	5			
Motor	Type	1-phase induction motor			
	Output	kW	0.018	0.023	
Air filter			PP Honeycomb fabric (washable)		
Refrigerant pipe diameter	Gas	mm(in.)	ø12.7 (ø1/2) Brazed		
	Liquid	mm(in.)	ø6.35 (ø1/4) Brazed		
Field drain pipe diameter			O.D. 26(1)		
Sound pressure level (Lo-Mid-Hi)	220V	dB(A)	20-25-30		20-25-33
	230V		21-26-32		21-26-35
	240V		22-27-30		22-27-33

### Notes:

\*1 Cooling/Heating capacity indicates the maximum value at operation under the following condition.

Cooling : Indoor 27°C (81°F) DB/19°C (66°F) WB, Outdoor 35°C (95°F) DB

Heating : Indoor 20°C (68°F) DB, Outdoor 7°C (45°F) DB/6°C (43°F) WB

\*2 The external static pressure is set to 5Pa (at 220V, 230V, 240V).

\*3 Measured in anechoic room. Sound pressure levels of the unit with a rear air inlet. (Sound pressure levels are higher than the unit with a bottom air inlet.)



# INDOOR UNIT

## Ceiling concealed type



### PEFY-P VMS1(L)-E

<b>Static Pressure</b> 5~50Pa	<b>Height</b> 200mm 7-28/32in.	<b>Low Noise</b>	<b>Width</b> 790mm 31-1/8in.	<b>Width</b> 990mm 39in.	<b>Width</b> 1,190mm 46-7/8in.
----------------------------------	--------------------------------------	------------------	------------------------------------	--------------------------------	--------------------------------------

The ultra thin unit of 200mm offers increased flexibility, and is particularly suitable for places where low noise operation is desired for a slim line body.



#### Changeable static pressure

The unit is made suitable for a variety of applications with its four static pressure settings of 5, 15, 35, 50Pa.

#### Changeable airflow rate

Low, middle, and high fan speed settings deliver precise comfort.

#### Choice for drain pump

Drain pump is an optional part for the VMS1L, and a standard for VMS1.

\*For places where low noise operation is especially required (i.e. Hotels), VMS1L (without drain pump) is recommended.

#### PP Honeycomb fabric

Washable PP Honeycomb fabric filter as standard

**Ultra low height unit with 200mm (7-28/32in.) high  
Ultra-narrow width of 790mm (P15-P32 models)  
[990mm for P40,50 models / 1190mm for P63 models]**

Can be installed easily in tight spaces, such as ceiling cavities or drop-ceilings.

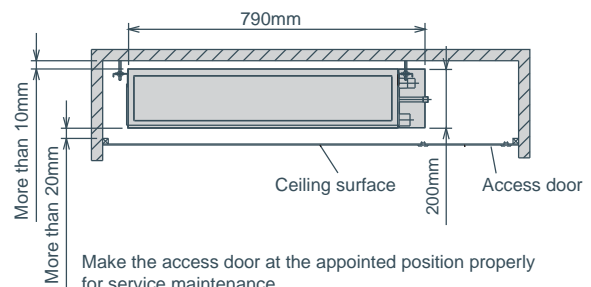

#### Reduced noise thanks to the use of newly designed centrifugal fan and coil

Sound pressure level table (Standard static pressure) at 15Pa

		dB(A)							
Sound pressure Level	Capacity	P15	P20	P25	P32	P40	P50	P63	
	Fan Speed	High	28	29	30	32	33	35	36
Mid	24	25	26	27	30	32	33		
Low	22	23	24	24	28	30	30		



## ► Specifications

		PEFY-P15VMS1(L)-E	PEFY-P20VMS1(L)-E	PEFY-P25VMS1(L)-E	PEFY-P32VMS1(L)-E	PEFY-P40VMS1(L)-E	PEFY-P50VMS1(L)-E	PEFY-P63VMS1(L)-E	
Power source		1-phase 220-240V 50Hz / 1-phase 220-240V 60Hz							
Cooling capacity	*1 kW	1.7	2.2	2.8	3.6	4.5	5.6	7.1	
	*1 BTU/h	5,800	7,500	9,600	12,300	15,400	19,100	24,200	
Heating capacity	*1 kW	1.9	2.5	3.2	4.0	5.0	6.3	8.0	
	*1 BTU/h	6,500	8,500	10,900	13,600	17,100	21,500	27,300	
Power consumption	*3 Cooling kW	0.05 [0.03]	0.05 [0.03]	0.06 [0.04]	0.07 [0.05]	0.07 [0.05]	0.09 [0.07]	0.09 [0.07]	
	*3 Heating kW	0.03 [0.03]	0.03 [0.03]	0.04 [0.04]	0.05 [0.05]	0.05 [0.05]	0.07 [0.07]	0.07 [0.07]	
Current	*3 Cooling A	0.42 [0.31]	0.47 [0.36]	0.50 [0.39]	0.50 [0.39]	0.56 [0.45]	0.67 [0.56]	0.72 [0.61]	
	*3 Heating A	0.31 [0.31]	0.36 [0.36]	0.39 [0.39]	0.39 [0.39]	0.45 [0.45]	0.56 [0.56]	0.61 [0.61]	
External finish		Galvanized							
Dimension		200 x 790 x 700				200 x 990 x 700		200 x 1,190 x 700	
H x W x D		In. 7-7/8 x 31-1/8 x 27-9/16				7-7/8 x 39 x 27-9/16		7-7/8 x 46-7/8 x 27-9/16	
Net weight		*3 kg(lbs.) 19(42) [18(40)]			20(45) [19(42)]		24(53) [23(51)]	28(62) [27(60)]	
Heat exchanger		Cross fin (Aluminium fin and copper tube)							
Fan	Type x Quantity	Sirocco fan x 2			Sirocco fan x 3		Sirocco fan x 4		
	Airflow rate (Lo-Mid-Hi)	m <sup>3</sup> /min	5-6-7	5.5-6.5-8	5.5-7-9	6-8-10	8-9.5-11	9.5-11-13	12-14-16.5
		L/s	83-100-117	91-108-133	91-117-150	100-133-167	133-158-183	158-183-217	200-233-275
	cfm	176-212-247	194-229-282	194-247-317	212-282-353	282-335-388	335-388-459	424-494-583	
External static press	Pa	5-15-35-50							
Motor type		DC motor							
Motor output		0.096							
Air filter		PP Honeycomb fabric (washable)							
Refrigerant pipe diameter	Gas	mm(in.) ø12.7 (ø1/2) Brazed					ø15.88 (ø5/8) Brazed		
	Liquid	mm(in.) ø6.35 (ø1/4) Brazed					ø9.52 (ø3/8) Brazed		
Field drain pipe diameter		mm(in.) O.D. 32 (1-1/4)							
Sound pressure level (Lo-Mid-Hi) (measured in anechoic room)		dB<A>	22-24-28	23-25-29	24-26-30	24-27-32	28-30-33	30-32-35	30-33-36

### Notes:

\*1 Cooling/Heating capacity indicates the maximum value at operation under the following condition.  
 Cooling : Indoor : 27°C D.B./19°C W.B. (81°F D.B. / 66°F W.B.) Outdoor : 35°C D.B. (95°F D.B.)  
 Heating : Indoor : 20°C D.B. (68°F D.B.) Outdoor : 7°C D.B. / 6°C W.B. (45°F D.B. / 43°F W.B.)  
 Pipe length : 7.5m (24-9/16ft) Height difference : 0m (0ft)

\*2 The external static pressure is set to 15 Pa at factory shipment.

\*3 [ ] is in case of PEFY-P15-63VMS1L-E



# INDOOR UNIT Ceiling Concealed Type

## PEFY-P VMA(L)-E

Middle Static Pressure  
**35~150Pa**

Slim Body  
**Height 250mm**

With precise control of indoor temperature while operating with optimum energy usage, it offers a high-energy efficiency.



### Compact Indoor Units

For all models, unit height are unified to 250mm. Compared to the previous model, the height size is reduced, allowing installation in tight spaces, such as ceiling cavities or drop-ceilings.

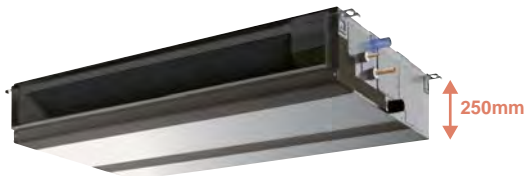

Reduction in height size

PEFY-P VMA(L)	20	25	32	40	50	63	71	80	100	125	140
Height mm	250										
Width mm	700		900		1,100		1,400		1,600		
Depth mm	732										

### External static pressure

Five-stage external static pressure settings provide flexibility for duct extension, branching and air outlet configuration and are adjustable to meet different application conditions.

Setting ranges to a maximum of 150Pa.

#### External static pressure setting

Series	20	25	32	40	50	63	71	80	100	125	140
PEFY-P VMA(L)	35/50/70/100/150Pa										

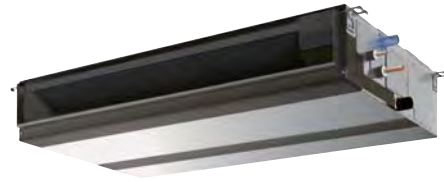

### Air Inlet

(1) Rear inlet

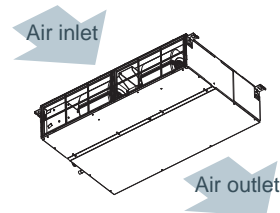

(2) Bottom inlet

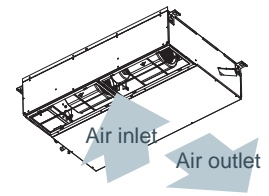

### Drain Pump Option

The line-up consists of two types, models with or without a built-in drain pump allowing more freedom in piping layout design.



PEFY-P VMA-E Drain pump built-in



PEFY-P VMAL-E No Drain pump

\* Units with a "L" at the end of the model name are not equipped with a drain pump.

### Analogue input

Analogue input allows unit to control the fan speed setting in conjunction with damper condition.

### IT terminal

IT terminal is available. For details, contact your local distributor.

# ► Specifications

		PEFY-P20VMA(L)-E	PEFY-P25VMA(L)-E	PEFY-P32VMA(L)-E	PEFY-P40VMA(L)-E	PEFY-P50VMA(L)-E	
Power source		1-phase 220-230-240V 50 / 60Hz					
Cooling capacity *1 (Nominal)	*1 kW	2.2	2.8	3.6	4.5	5.6	
	*1 BTU/h	7,500	9,600	12,300	15,400	19,100	
Heating capacity (Nominal)	*2 kW	2.5	3.2	4.0	5.0	6.3	
	*2 BTU/h	8,500	10,900	13,600	17,100	21,500	
Power consumption	*3 Cooling kW	0.06 [0.04]	0.06 [0.04]	0.07 [0.05]	0.09 [0.07]	0.11 [0.09]	
	*3 Heating kW	0.04	0.04	0.05	0.07	0.09	
Current	*3 Cooling A	0.53 [0.42]	0.53 [0.42]	0.55 [0.44]	0.64 [0.53]	0.74 [0.63]	
	*3 Heating A	0.42	0.42	0.44	0.53	0.63	
External finish		Galvanized steel plate					
Dimension H x W x D	mm	250 x 700 x 732	250 x 700 x 732	250 x 700 x 732	250 x 900 x 732	250 x 900 x 732	
	in.	9-7/8 x 27-9/16 x 28-7/8	9-7/8 x 27-9/16 x 28-7/8	9-7/8 x 27-9/16 x 28-7/8	9-7/8 x 35-7/16 x 28-7/8	9-7/8 x 35-7/16 x 28-7/8	
Net weight	kg(lbs)	23 (51) [22 (49)]	23 (51) [22 (49)]	23 (51) [22 (49)]	26 (58) [25 (56)]	26 (58) [25 (56)]	
Heat exchanger		Cross fin (Aluminum fin and copper tube)					
Fan	Type x Quantity	Sirocco fan x 1					
	Airflow rate (Low-Mid-High)	m <sup>3</sup> /min	6.0 - 7.5 - 8.5	6.0 - 7.5 - 8.5	7.5 - 9.0 - 10.5	10.0 - 12.0 - 14.0	12.0 - 14.5 - 17.0
		L/s	100 - 125 - 142	100 - 125 - 142	125 - 150 - 175	167 - 200 - 233	200 - 242 - 283
		cfm	212 - 265 - 300	212 - 265 - 300	265 - 318 - 371	353 - 424 - 494	424 - 512 - 600
External static pressure *4	Pa	<35> - 50 - <70> - <100> - <150>	<35> - 50 - <70> - <100> - <150>	<35> - 50 - <70> - <100> - <150>	<35> - 50 - <70> - <100> - <150>	<35> - 50 - <70> - <100> - <150>	
Motor	Type	DC motor					
	Output kW	0.085	0.085	0.085	0.085	0.085	
Air filter		PP honeycomb fabric.					
Refrigerant pipe diameter	Liquid (R410A) (R22,R407C) mm(in.)	6.35 (1/4) Brazed	6.35 (1/4) Brazed	6.35 (1/4) Brazed	6.35 (1/4) Brazed	6.35 (1/4) Brazed	
	Gas (R410A) (R22,R407C) mm(in.)	12.7 (1/2) Brazed	12.7 (1/20) Brazed	12.7 (1/20) Brazed	12.7 (1/20) Brazed	12.7 (1/2) Brazed	
Field drain pipe diameter	mm(in.)	O.D.32 (1-1/4)	O.D.32 (1-1/4)	O.D.32 (1-1/4)	O.D.32 (1-1/4)	O.D.32 (1-1/4)	
Sound pressure level (measured in anechoic room)							
(Low-Mid-High) *3 *5	dB(A)	26-28-29	26-28-29	28-30-34	28-30-34	28-32-35	
	*3 *6 dB(A)	23-25-26	23-25-26	23-26-29	23-27-30	25-29-32	

		PEFY-P63VMA(L)-E	PEFY-P71VMA(L)-E	PEFY-P80VMA(L)-E	PEFY-P100VMA(L)-E	PEFY-P125VMA(L)-E	PEFY-P140VMA(L)-E	
Power source		1-phase 220-230-240V 50 / 60Hz						
Cooling capacity *1 (Nominal)	*1 kW	7.1	8.0	9.0	11.2	14.0	16.0	
	*1 BTU/h	24,200	27,300	30,700	38,200	47,800	54,600	
Heating capacity (Nominal)	*2 kW	8.0	9.0	10.0	12.5	16.0	18.0	
	*2 BTU/h	27,300	30,700	34,100	42,700	54,600	61,400	
Power consumption	*3 Cooling kW	0.12 [0.10]	0.14 [0.12]	0.14 [0.12]	0.24 [0.22]	0.34 [0.32]	0.36 [0.34]	
	*3 Heating kW	0.10	0.12	0.12	0.22	0.32	0.34	
Current	*3 Cooling A	1.01 [0.90]	1.15 [1.04]	1.15 [1.04]	1.47 [1.36]	2.05 [1.94]	2.21 [2.10]	
	*3 Heating A	0.90	1.04	1.04	1.36	1.94	2.10	
External finish		Galvanized steel plate						
Dimension H x W x D	mm	250 x 1,100 x 732	250 x 1,100 x 732	250 x 1,100 x 732	250 x 1,400 x 732	250 x 1,400 x 732	250 x 1,600 x 732	
	in.	9-7/8 x 43-5/16 x 28-7/8	9-7/8 x 43-5/16 x 28-7/8	9-7/8 x 43-5/16 x 28-7/8	9-7/8 x 55-1/8 x 28-7/8	9-7/8 x 55-1/8 x 28-7/8	9-7/8 x 63 x 28-7/8	
Net weight	kg(lbs)	32 (71) [31 (69)]	32 (71) [31 (69)]	32 (71) [31 (69)]	42 (93) [41 (91)]	42 (93) [41 (91)]	46 (102) [45 (10)]	
Heat exchanger		Cross fin (Aluminum fin and copper tube)						
Fan	Type x Quantity	Sirocco fan x 2						
	Airflow rate (Low-Mid-High)	m <sup>3</sup> /min	13.5 - 16.0 - 19.0	14.5 - 18.0 - 21.0	14.5 - 18.0 - 21.0	23.0 - 28.0 - 33.0	28.0 - 34.0 - 40.0	29.5 - 35.5 - 42.0
		L/s	225 - 267 - 317	242 - 300 - 350	242 - 300 - 350	383 - 467 - 550	467 - 567 - 667	492 - 592 - 700
		cfm	477 - 565 - 671	512 - 636 - 742	512 - 636 - 742	812 - 989 - 1,165	989 - 1,201 - 1,412	1,042 - 1,254 - 1,483
External static pressure *4	Pa	<35> - 50 - <70> - <100> - <150>	<35> - 50 - <70> - <100> - <150>	<35> - 50 - <70> - <100> - <150>	<35> - 50 - <70> - <100> - <150>	<35> - 50 - <70> - <100> - <150>	<35> - 50 - <70> - <100> - <150>	
Motor	Type	DC motor						
	Output kW	0.121	0.121	0.121	0.244	0.244	0.244	
Air filter		PP honeycomb fabric.						
Refrigerant pipe diameter	Liquid (R410A) (R22,R407C) mm(in.)	9.52 (3/8) Brazed	9.52 (3/8) Brazed	9.52 (3/8) Brazed	9.52 (3/8) Brazed	9.52 (3/8) Brazed	9.52 (3/8) Brazed	
	Gas (R410A) (R22,R407C) mm(in.)	15.88 (5/8) Brazed	15.88 (5/8) Brazed	15.88 (5/8) Brazed	15.88 (5/8) Brazed	15.88 (5/8) Brazed	15.88 (5/8) Brazed	
Field drain pipe diameter	mm(in.)	O.D.32 (1-1/4)	O.D.32 (1-1/4)	O.D.32 (1-1/4)	O.D.32 (1-1/4)	O.D.32 (1-1/4)	O.D.32 (1-1/4)	
Sound pressure level (measured in anechoic room)								
(Low-Mid-High) *3 *5	dB(A)	29-32-36	30-34-38	30-34-38	32-37-41	35-40-44	36-41-45	
	*3 *6 dB(A)	25-29-33	26-29-34	26-29-34	28-33-37	32-36-40	33-37-42	

## Notes:

- \* [ ] is in case of PEFY-P VMALE
- \*1 Nominal cooling conditions  
Indoor: 27°CDB/19°CWB(81°FDB/66°FWB), Outdoor: 35°CDB(95°FDB)  
Pipe length: 7.5m(24-9/16ft.), Level difference: 0m(0ft.)
- \*2 Nominal heating conditions  
Indoor: 20°CDB(68°FDB), Outdoor: 7°CDB/6°CWB(45°FDB/43°FWB)  
Pipe length: 7.5m(24-9/16ft.), Level difference: 0m(0ft.)
- \*3 The values are measured at the rated external static pressure.
- \*4 The rated external static pressure is shown without < > .The factory setting is the rated value.

- \*5 Measured in anechoic room with a 1m air inlet duct and 2m air outlet duct attached to the unit and 1.5m below the unit.

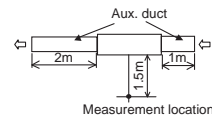

- \*6 Measured in anechoic room with a 2m air inlet duct and 2m air outlet duct attached to the unit and 1.5m below the unit.

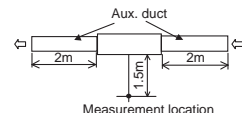

# INDOOR UNIT

## Ceiling concealed type

### PEFY-P VMH(S)-E

High Static Pressure



Increased design flexibility from sufficient external static pressure allows authentic duct air-conditioning with an elegant interior layout.



#### High static pressure of 200 Pa or higher

The additional external static pressure capacity provides flexibility for duct extension, branching and air outlet configuration.

PEFY-P VMH-E		P40	P50	P63	P71	P80	P100	P125	P140	P200	P250
External static pressure (Pa)	220V	50/100/200									—
	230/240V	100/150/200									—
	380V	—									110/220
	400/415V	—									130/260

PEFY-P VMHS-E	P200	P250
External static pressure (Pa)	<50> - <100> - 150 - <200> - <250>*	

\*The rated external static pressure is shown without <>. The factory setting is the rated value.

#### Reduced noise thanks to the use of newly designed centrifugal fan

Sound pressure level table (Standard static pressure 220V)

Sound pressure Level	Capacity		dB(A)							
	Fan Speed	High	P40	P50	P63	P71	P80	P100	P125	P140
		Low	27	27	32	32	35	34	34	34
			34	34	38	39	41	42	42	42

#### One-side maintenance

All maintenance to the unit, including fan inspection and fan motor removal, can be conducted from the inspection opening on one side. (VMH model only)

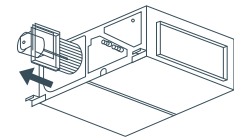

#### Drain pump (option) ensures up to 550mm (21-11/16in.) for VMH model / 700mm (27-9/16in.) for VMHS model of lift

The introduction of an upper drain pump allows the drain connection to be raised as high as 550mm(21-11/16in.) for VMH model/700mm (27-9/16in.) for VMHS model, allowing more freedom in piping layout design and reducing horizontal piping requirements.

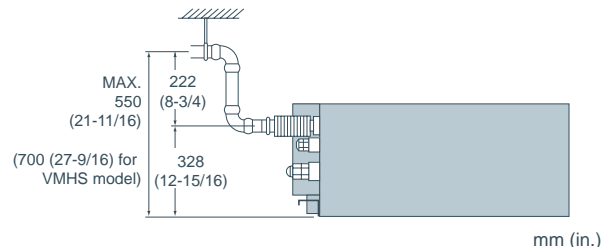

## ► Specifications

		PEFY-P40VMH-E	PEFY-P50VMH-E	PEFY-P63VMH-E	PEFY-P71VMH-E	PEFY-P80VMH-E	PEFY-P100VMH-E	PEFY-P125VMH-E	PEFY-P140VMH-E	
Power source		1-phase 220-240V 50Hz / 1-phase 220-240V 60Hz								
Cooling capacity	*1 kW	4.5	5.6	7.1	8.0	9.0	11.2	14.0	16.0	
	*1 BTU/h	15,400	19,100	24,200	27,300	30,700	38,200	47,800	54,600	
Heating capacity	*1 kW	5.0	6.3	8.0	9.0	10.0	12.5	16.0	18.0	
	*1 BTU/h	17,100	21,500	27,300	30,700	34,100	42,700	54,600	61,400	
Power consumption	Cooling kW	0.19 / 0.23		0.24 / 0.30	0.26 / 0.33	0.32 / 0.40	0.48 / 0.58		0.48 / 0.59	
	Heating kW	0.19 / 0.23		0.24 / 0.30	0.26 / 0.33	0.32 / 0.40	0.48 / 0.58		0.48 / 0.59	
Current	Cooling A	0.88 / 1.06		1.12 / 1.38	1.20 / 1.51	1.47 / 1.83	2.34 / 2.66		2.35 / 2.70	
	Heating A	0.88 / 1.06		1.12 / 1.38	1.20 / 1.51	1.47 / 1.83	2.34 / 2.66		2.35 / 2.70	
External finish		Galvanized								
Dimension H x W x D	mm	380 x 750 x 900			380 x 1,000 x 900			380 x 1,200 x 900		
	in.	15 x 29-9/16 x 35-7/16			15 x 39-3/8 x 35-7/16			15 x 47-1/4 x 35-7/16		
Net weight	kg(lbs.)	44 (98)	45 (100)		50 (111)		70 (155)			
Heat exchanger		Cross fin (Aluminum plate fin and copper tube)								
Fan	Type x Quantity	Sirocco fan x 1				Sirocco fan x 2				
	Airflow rate (Lo-Hi)	m <sup>3</sup> /min	10.0-14.0		13.5-19.0	15.5-22.0	18.0-25.0	26.5-38.0		28.0-40.0
		L/s	167-233		225-317	258-367	300-417	442-633		467-667
		cfm	353-494		477-671	547-777	636-883	936-1342		989-1413
	External static pressure *2	220V Pa	50 · 100 · 200							
230,240V Pa		100 · 150 · 200								
Motor	Type	1-phase induction motor								
	Output *3 kW	0.08		0.12	0.14	0.18	0.26			
Air filter (option)		Synthetic fiber unwoven cloth filter (long life)								
Refrigerant pipe diameter	Gas (Flare) mm(in.)	ø12.7 (ø1/2)			ø15.88 (ø5/8)					
	Liquid (Flare) mm(in.)	ø6.35 (ø1/4)			ø9.52 (ø3/8)					
Field drain pipe diameter		mm(in.) O.D. 32 (1-1/4)								
Sound pressure level (Lo-Hi) *6	220V dB(A)	27-34		32-38	32-39	35-41	34-42			
	230,240V dB(A)	31-37		36-41	35-41	38-43	38-44			

		PEFY-P200VMH-E	PEFY-P250VMH-E	PEFY-P200VMHS-E	PEFY-P250VMHS-E	
Power source		3-phase 380-415V 50Hz / 3N - 380-415V 60Hz		1-phase 220-240V 50Hz / 1-phase 220-240V 60Hz		
Cooling capacity	*1 kW	22.4	28.0	22.4	28.0	
	*1 BTU/h	76,400	95,500	76,400	95,500	
Heating capacity	*1 kW	25.0	31.5	25.0	31.5	
	*1 BTU/h	85,300	107,500	85,300	107,500	
Power consumption	Cooling kW	0.99 / 1.14		1.23 / 1.41	0.63 *7	
	Heating kW	0.99 / 1.14		1.23 / 1.41	0.63 *7	
Current	Cooling	380-415V A	1.62 / 1.86		2.00 / 2.30	—
		220-230-240V A	—		—	3.47-3.32-3.18 *7
	Heating	380-415V A	1.62 / 1.86		2.00 / 2.30	—
		220-230-240V A	—		—	3.47-3.32-3.18 *7
External finish		Galvanized		Galvanized steel plate		
Dimension H x W x D	mm	470 x 1,250 x 1,120		470 x 1,250 x 1,120		
	in.	18-9/16 x 49-1/4 x 44-1/8		18-9/16 x 49-1/4 x 44-1/8		
Net weight	kg(lbs.)	100 (221)		97 (214)	100 (221)	
Heat exchanger		Cross fin (Aluminum plate fin and copper tube)		Cross fin (Aluminum plate fin and copper tube)		
Fan	Type x Quantity	Sirocco fan x 2		Sirocco fan x 2		
	Airflow rate	m <sup>3</sup> /min	58.0	72.0	—	—
		L/s	967	1200	—	—
		cfm	2048	2543	—	—
	Lo-Mid-Hi	m <sup>3</sup> /min	—	—	50.0-61.0-72.0	58.0-71.0-84.0
		L/s	—	—	833-1017-1200	967-1183-1400
		cfm	—	—	1766-2154-2542	2048-2507-2966
	External static pressure	380V Pa	110 · 220 *4		—	
400,415V Pa		130 · 260 *4		—		
Pa		—		<50>-<100>-150-<200>-<250> *8		
mmH <sub>2</sub> O		—		<5.1>-<10.2>-15.3-<20.4>-<25.5> *8		
Motor	Type	3-phase induction motor		DC motor		
	Output kW	0.76 *5	1.08 *5	0.87	0.87	
Air filter(option)		Synthetic fiber unwoven cloth filter (long life)		Synthetic fiber unwoven cloth filter (long life filter) and filter box are recommended.		
Refrigerant pipe diameter	Gas (Brazed) mm(in.)	ø19.05 (ø3/4)		ø19.05 (ø3/4)	ø22.2 (ø7/8)	
	Liquid (Brazed) mm(in.)	ø9.52 (ø3/8)		ø9.52 (ø3/8)		
Field drain pipe diameter		mm(in.) O.D. 32 (1-1/4)				
Sound pressure level	380V dB(A)	42 (110Pa) / 45 (220Pa) *6		50 (110Pa) / 52 (220Pa) *6		
	400,415V dB(A)	44 (130Pa) / 47 (260Pa) *6		52 (130Pa) / 54 (260Pa) *6		
	Lo-Mid-Hi dB(A)	—		—		
	Lo-Mid-Hi dB(A)	—		36-39-43 *9	39-42-46 *9	

### Notes:

- \*1 Cooling/heating capacity indicates the maximum value at operation under the following condition.  
Cooling Indoor : 27°C(81°F)DB/19°C(66°F)WB, Outdoor : 35°C(95°F)DB  
Heating Indoor : 20°C(68°F)DB, Outdoor : 7°C(45°F)DB/6°C(43°F)WB
- \*2 The external static pressure is set to 100Pa (at 220V) /150Pa (at 230, 240V) at factory shipment.
- \*3 The value are that at 240V.
- \*4 The external static pressure is set to 220Pa (at 380V) /260Pa (at 400, 415V) at factory shipment.
- \*5 The value are that at 415V.

- \*6 It is measured in anechoic room.
- \*7 The values are measured at the rated external static pressure.
- \*8 The rated external static pressure is shown without < > .  
The factory setting is the rated value.
- \*9 It is measured at the rated external static pressure in anechoic room.

# INDOOR UNIT Fresh Air Intake Type

PEFY-P VMH-E-F

**Fresh Air Intake**

Fresh Air can be taken in with temperature control.  
Ideal for Offices, Stores and Restaurants.



**The Fresh Air intake indoor unit can be installed in any place.**

The Fresh Air intake indoor unit can take fresh outdoor air into any building in any place at any time.

**Office, Lobby, Workshop, Rest room, Nursing home, Smoking corner, Kitchen in restaurant**

**\* Limits of capacity connectable to outdoor unit**  
Max. 110% of outdoor unit capacity, except heating at outdoor temperature of less than -5°C(23°F) (100%).

Example

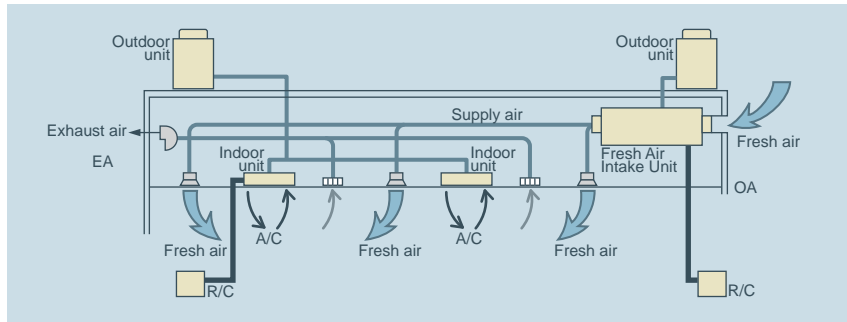

< Note >

Fan remains in operation during Thermo-OFF. Using this model with another type of indoor unit is recommended to prevent cold draft which is caused due to intaken fresh air.



## ► Specifications

		PEFY-P80VMH-E-F		PEFY-P140VMH-E-F		
Power source		1-phase 220-240V 50Hz / 1-phase 208-230V 60Hz				
Cooling capacity	*1	kW	9.0	16.0		
	*1	BTU/h	30,700	54,600		
Heating capacity	*1	kW	8.5	15.1		
	*1	BTU/h	29,000	51,500		
Power consumption	Cooling	kW	0.16 / 0.21	0.29 / 0.33		
	Heating	kW	0.16 / 0.21	0.29 / 0.33		
Current	Cooling	A	0.67 / 0.91	1.24 / 1.48		
	Heating	A	0.67 / 0.91	1.24 / 1.48		
External finish		Galvanized				
Dimension H x W x D		mm(in.)	380 x 1000 x 900 (15 x 39-3/8 x 35-7/16)	380 x 1200 x 900 (15 x 47-1/4 x 35-7/16)		
Net weight		kg(lbs.)	50 (111)	70 (155)		
Heat exchanger		Cross fin (Aluminum plate fin and copper tube)				
Fan	Type x Quantity		Sirocco fan x 1		Sirocco fan x 2	
	Airflow rate		m <sup>3</sup> /min	9.0	18.0	
			L/s	150	300	
			cfm	318	636	
	External static pressure (Lo-Mid-Hi)	208V	Pa	35 - 85 - 170	35 - 85 - 170	
		220V	Pa	40 - 115 - 190	50 - 115 - 190	
		230V	Pa	50 - 130 - 210	60 - 130 - 220	
240V		Pa	80 - 170 - 220	100 - 170 - 240		
Motor		1-phase induction motor				
Output		kW	0.09 (at 220V)	0.14 (at 220V)		
Air filter (option)		Synthetic fiber unwoven cloth filter (long life)				
Refrigerant pipe diameter	Gas (Flare)	mm(in.)	ø15.88 (ø5/8)			
	Liquid (Flare)	mm(in.)	ø9.52 (ø3/8)			
Field drain pipe diameter		mm(in.)	O.D.32 (1-1/4)			
Sound pressure level (Lo-Mid-Hi) *2	208, 220V	dB(A)	27 - 38 - 43	28 - 38 - 43		
	230, 240V	dB(A)	33 - 43 - 45	34 - 43 - 45		

		PEFY-P200VMH-E-F		PEFY-P250 VMH-E-F		
Power source		3-phase 380-415V 50Hz / 3N- 380-415V 60Hz				
Cooling capacity		kW	22.4	28.0		
		BTU/h	76,400	95,500		
Heating capacity		kW	21.2	26.5		
		BTU/h	72,300	90,400		
Power consumption	Cooling	kW	0.34 / 0.42	0.39 / 0.50		
	Heating	kW	0.34 / 0.42	0.39 / 0.50		
Current	Cooling	A	0.58 / 0.74	0.68 / 0.86		
	Heating	A	0.58 / 0.74	0.68 / 0.86		
External finish		Galvanized				
Dimension H x W x D		mm(in.)	470 x 1250 x 1120 (18-9/16 x 49-1/4 x 44-1/8)			
Net weight		kg(lbs.)	100 (221)			
Heat exchanger		Cross fin (Aluminum plate fin and copper tube)				
Fan	Type x Quantity		Sirocco fan x 2			
	Airflow rate		m <sup>3</sup> /min	28	35	
			L/s	467	583	
			cfm	989	1236	
	External static pressure	380V	Pa	140 / 200	110 / 190	
		400V	Pa	150 / 210	120 / 200	
		415V	Pa	160 / 220	130 / 210	
Motor		3-phase induction motor				
Output		kW	0.20	0.23		
Air filter (option)		Synthetic fiber unwoven cloth filter (long life type)				
Refrigerant pipe diameter	Gas (Flare)	mm(in.)	ø19.05 (ø3/4)		ø22.2 (ø7/8)	
	Liquid (Flare)	mm(in.)	ø9.52 (ø3/8)			
Field drain pipe diameter		mm(in.)	O.D.32 (1-1/4)			
Sound pressure level *2	380V	dB(A)	39 / 42	40 / 44		
	400V	dB(A)	40 / 43	40 / 45		
	415V	dB(A)	40 / 44	41 / 46		

### Notes:

- The cooling and heating capacities are the maximum capacities that were obtained by operating in the above air conditions and with a refrigerant pipe of about 7.5m.
- The actual capacity characteristics vary with the combination of indoor and outdoor units. See the technical information.
- The operating noise is the data that was obtained by measuring it 1.5m from the bottom of the unit in an anechoic room. (Noise meter A-scale value)
- The figure of Electrical characteristic indicates at 240V 50Hz/230V60Hz (PEFY-P80, 140VMH-E-F type), at 220Pa setting at 415V (PEFY-P200, 250VMH-E-F type).
- When the 100% fresh air indoor units are connected, the maximum connectable indoor units to 1 outdoor unit are as follows

Heat pump models	Cooling only
110%(100% in case of heating below-5°C(23°F))	110%

- Operational temp range is (Cooling : from 21°C(70°F)DB/15.5°C(60°F)WB to 43°C(109°F)DB/35°C(95°F)WB)  
Heating : from -10°C(14°F)DB to 20°C(68°F)DB

\* Thermo off(Fan) operation automatically starts either when temperature is lower than 21°C(70°F)DB in cooling mode or when the temperature exceeds 20°C(68°F)DB in heating mode.

- As the room temp in sensed by the thermo in the remote controller or the one in the room, be sure to use either remote controller or room thermo.
- Autochangeover function or Dry mode is NOT available. Fan mode operation during the thermo off in Cooling/Heating mode.
- In any case, the air flow rate should be kept lower than 110% of the above chart. Please see "Fan curves" for the details.
- When this unit is used as sole A/C system, be careful about the dew in air outlet grilles in cooling mode.
- Un-conditioned outdoor air such as humid air or cold air blows to the indoor during thermo off operation.  
Please be careful when positioning indoor unit air outlet grilles, ie take the necessary precautions for cold air, and also insulate rooms for dew condensation prevention as required.
- Air filter must be installed in the air intake side. The filter should be attached where easy maintenance is possible in case of usage of field supply filters.
- Long life cannot be used with Hi-efficiency filter together (PEFY-P80 · 140VMH-E-F type).

# INDOOR UNIT

## Ceiling suspended type

### PCFY-P VKM-E



Designed for ultra-quiet operation and easy maintenance, provides exceptionally comfortable air-conditioning.



**Extra slim, extra stylish**

Sleek and slim with stylishly curved lines, the PCFY series blends right into any interior. It also features a single air outlet which allows the auto vane to act as a shutter when the unit is turned off.

#### Auto vane distributes air evenly

The auto vane swings up and down automatically to distribute air more evenly to every corner of the room.

#### Long life filter as standard

Long life filter is equipped as standard enabling up to 2,500 hours of operation (office use) without maintenance.

#### Keeps airflow at optimum level according to ceiling height

The most suitable airflow can be selected for ceilings up to 4.2m high, enhancing air-conditioning efficiency and comfort. (P100/P125)

	Standard	High ceiling
Ceiling height	3.0(9-13/16)	4.2(13-3/4)

m (ft)

#### Simplified installation

The direct suspension system eliminates the task of removing the attachment fixture from the main unit, greatly shortening installation time.

#### Drain pump option available with all models

The pumping height of the optional drain pump has been increased from 400mm to 600 mm, expanding flexibility in choosing unit location during installation work.

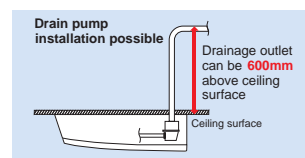

#### Outside-air intake

Units are equipped with a knock-out hole that enables the induction of fresh outside-air.

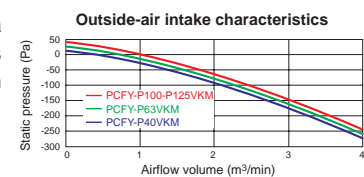

#### Equipped with automatic air-speed adjustment

In addition to the conventional 4-speed setting, units are now equipped with an automatic air-speed adjustment mode. This setting automatically adjusts the air-speed to conditions that match the room environment. At the start of heating/cooling operation, the airflow is set to high-speed to quickly heat/cool the room. When the room temperature reaches the desired setting, the airflow speed is decreased automatically for stable comfortable heating/cooling operation.

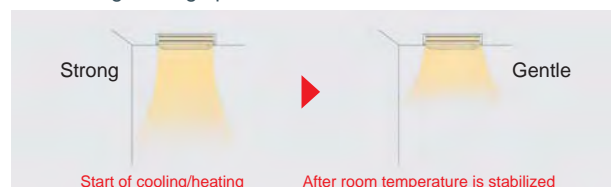



## ► Specifications

			PCFY-P40VKM-E	PCFY-P63VKM-E	PCFY-P100VKM-E	PCFY-P125VKM-E
Power source			1-phase 220-240V 50Hz / 1-phase 220V 60Hz			
Cooling capacity	*1	kW	4.5	7.1	11.2	14.0
	*1	BTU/h	15,400	24,200	38,200	47,800
Heating capacity	*1	kW	5.0	8.0	12.5	16.0
	*1	BTU/h	17,100	27,300	42,700	54,600
Power consumption	Cooling	kW	0.04	0.05	0.09	0.11
	Heating	kW	0.04	0.05	0.09	0.11
Current	Cooling	A	0.28	0.33	0.65	0.76
	Heating	A	0.28	0.33	0.65	0.76
External finish(Munsell No.)			6.4Y 8.9/ 0.4			
Dimension H x W x D	mm		230 x 960 x 680	230 x 1,280 x 680	230 x 1,600 x 680	
	in.		9-1/16 x 37-13/16 x 26-3/4	9-1/16 x 50-3/8 x 26-3/4	9-1/16 x 63 x 26-3/4	
Net weight	kg(lbs.)		24(53)	32 (71)	36 (79)	38 (84)
Heat exchanger			Cross fin (Aluminum fin and copper tube)			
Fan	Type x Quantity		Sirocco fan x 2	Sirocco fan x 3	Sirocco fan x 4	
	Airflow rate *2 (Lo-Mid2-Mid1-Hi)	m <sup>3</sup> /min	10-11-12-13	14-15-16-18	21-24-26-28	21-24-27-31
		L/s	167-183-200-217	233-250-267-300	350-400-433-467	350-400-450-517
		cfm	353-388-424-459	494-530-565-636	742-847-918-989	742-847-953-1,095
External static pressure		Pa	0			
Motor	Type		DC motor			
	Output		kW	0.090	0.095	0.160
Air filter			PP Honeycomb (long life)			
Refrigerant pipe diameter	Gas (Flare)	mm(in.)	ø12.7 (ø1/2)	ø15.88 (ø5/8)	ø15.88 (ø5/8) / ø19.05 (ø3/4) (Compatible)	
	Liquid (Flare)	mm(in.)	ø6.35 (ø1/4)	ø9.52 (ø3/8)		
Field drain pipe diameter		mm(in.)	O.D. 26 (1)			
Sound pressure level (Lo-Mid2-Mid1-Hi) *2 *3		dB(A)	29-32-34-36	31-33-35-37	36-38-41-43	36-39-42-44

### Notes:

- \*1 Cooling/Heating capacity indicates the maximum value at operation under the following condition.  
Cooling Indoor : 27°C(80.6°F)DB/19°C(66.2°F)WB, Outdoor 35°C(95°F)DB  
Heating Indoor : 20°C(68°F)DB, Outdoor 7°C(44.6°F)DB/6°C(42.8°F)WB
- \*2 Airflow rate/Sound pressure level are shown in (low-middle 2-middle 1-high).
- \*3 It is measured in anechoic room.

# INDOOR UNIT

## Wall mounted type

PKFY-P VBM-E  
 PKFY-P VHM-E  
 PKFY-P VKM-E



PKFY-P VBM



PKFY-P VHM



PKFY-P VKM

**Elegant Design and Compact Dimensions Ideal for Offices, Stores and Residential Uses.**



Capacity range

Capacity	P15	P20	P25	P32	P40	P50	P63	P100
VBM	●	●	●					
VHM				●	●	●		
VKM							●	●

### 4-way piping provides more flexibility in selecting installation sites

All piping including drainage can be connected from the rear, right, base, and left of the unit, providing much greater flexibility in piping and selecting installation site.

### Flat panel & Pure white finish

All models have changed from the grill design, adopting the flat panel layout. Pursuing a design that harmonizes with virtually any interior, the unit color has been changed from white to pure white.



PKFY-P VGM



PKFY-P VFM



PKFY-P VHM



PKFY-P VKM

### Built-in signal receiver

#### PKFY-P VBM features

Compact profile

Quiet operation

#### PKFY-P VHM features

##### Compact size of 898mm

Width size reduced to match small size buildings and offices.

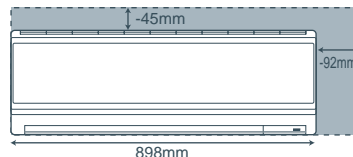

Comparison with PKFY-P VGM-E

##### Light unit

Approx. 3kg reduced from conventional model (P32-50). Easier installation.

##### Drain pump (option)

The optional drain pump allows the drain connection to be raised as high as 800mm, allowing more freedom in piping layout design.

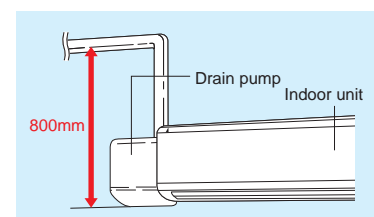

## ► Specifications

		PKFY-P15VBM-E	PKFY-P20VBM-E	PKFY-P25VBM-E	PKFY-P32VHM-E	PKFY-P40VHM-E	PKFY-P50VHM-E
Power source		1-phase 220-240V 50Hz / 1-phase 220V 60Hz					
Cooling capacity	*1 kW	1.7	2.2	2.8	3.6	4.5	5.6
	*1 BTU/h	5,800	7,500	9,600	12,300	15,400	19,100
Heating capacity	*1 kW	1.9	2.5	3.2	4.0	5.0	6.3
	*1 BTU/h	6,500	8,500	10,900	13,600	17,100	21,500
Power consumption	Cooling *4 kW	0.04		0.04		0.04	
	Heating kW	0.04		0.03		0.03	
Current	Cooling *4 A	0.20		0.20		0.40	
	Heating A	0.20		0.30		0.30	
External finish(Munsell No.)		Plastic (1.0Y 9.2/0.2)			Plastic (1.0Y 9.2/0.2)		
Dimension H x W x D		mm(in.) 295 x 815 x 225 (11-5/8 x 32-1/8 x 8-7/8)			mm(in.) 295 x 898 x 249(11-5/8 x 35-3/8 x 9-13/16)		
Net weight		kg(lbs.) 10 (23)			13(29)		
Heat exchanger		Cross fin (Aluminum fin and copper tube)					
Fan	Type x Quantity		Line flow fan x 1				
	Airflow rate *2 (Lo-Mid2-Mid1-Hi)	m <sup>3</sup> /min	4.9-5.0-5.2-5.3	4.9-5.2-5.6-5.9	9-10-11	9-10.5-11.5	9-10.5-12
		L/s	82-83-87-88	82-87-93-98	150-167-183	150-175-192	150-175-200
		cfm	173-177-184-187	173-184-198-208	318-353-388	318-371-406	318-371-424
External static pressure	Pa	0					
Motor	Type	1-phase induction motor			DC motor		
	Output	kW 0.017			0.030		
Air filter		PP Honeycomb					
Refrigerant pipe diameter	Gas (Flare)	mm(in.)	ø12.7 (ø1/2)			ø12.7 (ø1/2) / ø15.88 (ø5/8) (Compatible)	
	Liquid (Flare)	mm(in.)	ø6.35 (ø1/4)			ø6.35 (ø1/4) / ø9.52 (ø3/8) (Compatible)	
Field drain pipe diameter		mm(in.)	I.D.16 (5/8)				
Sound pressure level (Lo-Mid2-Mid1-Hi) *2 *3		dB(A)	29-31-32-33	29-31-34-36	34-37-41	34-38-41	34-39-43

### Notes:

\*1 Cooling/Heating capacity indicates the maximum value at operation under the following condition.  
Cooling Indoor : 27°C(81°F)DB/19°C(66°F)WB, Outdoor 35°C(95°F)DB  
Heating Indoor : 20°C(68°F)DB, Outdoor 7°C(45°F)DB/6°C(43°F)WB

\*2 Airflow rate/Sound pressure level are in (low-middle2-middle1-high).

\*3 It is measured in anechoic room.

\*4 Electrical characteristic of cooling are included optional drain-pump.

		PKFY-P63VKM-E	PKFY-P100VKM-E	
Power source		1-phase 220-230-240V 50Hz / 1-phase 220V 60Hz		
Cooling capacity	*1 kW	7.1	11.2	
	*1 BTU/h	24,200	38,200	
Heating capacity	*1 kW	8.0	12.5	
	*1 BTU/h	27,300	42,600	
Power consumption	Cooling *4 kW	0.05		
	Heating kW	0.04		
Current	Cooling *4 A	0.37		
	Heating A	0.30		
External finish(Munsell No.)		Plastic (1.0Y 9.2/0.2)		
Dimension H x W x D		mm(in.) 365 x 1,170 x 295 (14-3/8 x 46-1/16 x 11-5/8)		
Net weight		kg(lbs.) 21 (46)		
Heat exchanger		Cross fin (Aluminum fin and copper tube)		
Fan	Type x Quantity		Line flow fan x 1	
	Airflow rate *2 (Lo-Hi)	m <sup>3</sup> /min	16-20	20-26
		L/s	267-333	333-433
		cfm	565-706	706-918
External static pressure	Pa	0		
Motor	Type	DC motor		
	Output	kW 0.056		
Air filter		PP Honeycomb		
Refrigerant pipe diameter	Gas (Flare)	mm(in.) ø15.88 (ø5/8)	ø15.88 (ø5/8) / ø19.05 (ø3/4) (Compatible)	
	Liquid (Flare)	mm(in.)	ø9.52 (ø3/8)	
Field drain pipe diameter		mm(in.)	I.D. 16(5/8)	
Sound pressure level (Lo-Hi) *2 *3		dB(A)	39-45	41-49

### Notes:

\*1 Cooling/heating capacity indicates the maximum value at operation under the following condition.  
Cooling Indoor : 27°C(81°F)DB/19°C(66°F)WB, Outdoor : 35°C(95°F)DB  
Heating Indoor : 20°C(68°F)DB, Outdoor : 7°C(45°F)DB/6°C(43°F)WB

\*2 Airflow rate/Sound pressure level are in (low-high).

\*3 It is measured in anechoic room.

\*4 Electrical characteristic of cooling are included optional drain-pump.



# INDOOR UNIT

## Floor standing exposed

### PFFY-P VKM-E2



For living rooms, bed rooms, or offices.  
The latest Mitsubishi innovation – floor-standing air-conditioner sophisticated in design, rich in function.



#### Quiet operation

Mitsubishi Electric air conditioners have always been some of the quietest models available in the market. Our new floor-standing models are no exception. It can create a silent and comfortable space where the occupants would not even recognize the existence of air conditioner operation.

ONLY  
**27dB**

\*2.5kw class

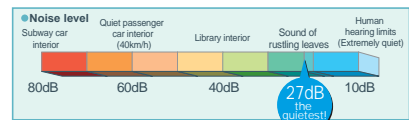

#### Sophisticated Design

An innovative floor-standing air-conditioner. A mix of streamlined form and diversified function. Engineered to keep room walls free, furnish comfy cooling in summer, toasty heating in winter.

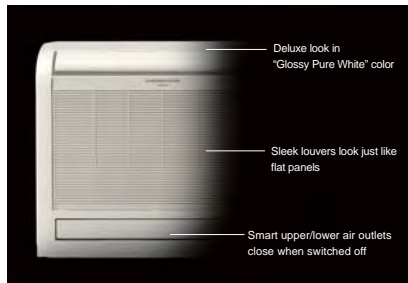

The "Glossy Pure White" colour ensures a deluxe look, the perfect match for any room. Both upper and lower air outlets remain closed when switched OFF, in a smart and striking image. A superb new air-conditioner from Mitsubishi, providing a handsome fit for your own distinctive interior.

#### Slim but Mighty

The unit body is slim and trim, the essence in compact. An ideal size for living rooms, bedrooms, and more. The removable and washable front panel makes cleaning simple.

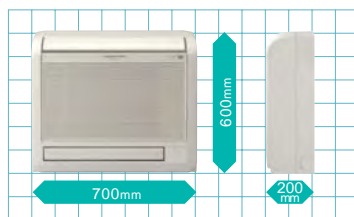

Easy and regular cleaning allows your air-conditioner to stay beautiful while keeping its energy-efficient operation possible.

#### Optimum Air Distribution

Comfy room temperatures are realised by the optimum, powerful and efficient air distribution through upper and lower air outlets. The upper vane angle is remote controllably, with 5 air flow direction levels (+Swing and Auto modes) and 4 wind power levels (+Auto mode). By setting the vane angle almost vertical, annoying direct wind can be avoided for your better comfort.



The air from both upper and lower air outlets is optimally controlled and distributed evenly to every corner of the room. In heating mode, the warm air is smartly controlled to stay at the floor level: Your feet do not feel chilled any more!

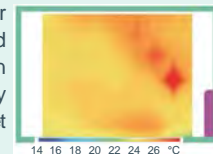

## ► Specifications

		PFFY-P20VKM-E2	PFFY-P25VKM-E2	PFFY-P32VKM-E2	PFFY-P40VKM-E2
Power source		1-phase 220-240V 50Hz			
Cooling capacity	*1 kW	2.2	2.8	3.6	4.5
	*1 BTU/h	7,500	9,600	12,300	15,400
Heating capacity	*1 kW	2.5	3.2	4.0	5.0
	*1 BTU/h	8,500	10,900	13,600	17,100
Power consumption	Cooling kW	0.025	0.025	0.025	0.028
	Heating kW	0.025	0.025	0.025	0.028
Current	Cooling A	0.20	0.20	0.20	0.24
	Heating A	0.20	0.20	0.20	0.24
External finish		Plastic (Pure white)			
Dimension		600 x 700 x 200			
H x W x D		23-5/8 x 27-9/16 x 7-7/8			
Net weight		15 (34)			
Heat exchanger		Cross fin (Aluminium plate fin and copper tube)			
Fan		Line flow fan x 2			
Fan	Type x Quantity				
	Airflow rate (Lo-Mid-Hi-SHi)	m <sup>3</sup> /min	5.9-6.8-7.6-8.7	6.1-7.0-8.0-9.1	6.1-7.0-8.0-9.1
Fan	External static pressure	Pa	0		
	Type	DC motor			
Motor	Output	kW			
Air filter		PP honeycomb fabric (Catechin Filter)			
Refrigerant pipe diameter	Gas(Flare)	mm(in.)	ø12.7 (ø1/2)		
	Liquid(Flare)	mm(in.)	ø6.35 (ø1/4)		
Field drain pipe diameter		I.D.16 (5/8)			
Sound pressure level (Lo-Mid-Hi-SHi)	*2 dB(A)	27-31-34-37	28-32-35-38	28-32-35-38	35-38-42-44

### Notes:

\*1 Cooling/heating capacity indicates the maximum value at operation under the following condition.  
Cooling Indoor : 27°C(81°F)DB/19°C(66°F)WB, Outdoor : 35°C(95°F)DB  
Heating Indoor : 20°C(68°F)DB, Outdoor : 7°C(45°F)DB/6°C(43°F)WB

\*2 Airflow rate/Sound pressure level are in (low-middle-high-shigh).

\*3 It is measured in anechoic room.



# INDOOR UNIT

## Floor standing exposed

---

PFFY-P VLEM-E



**Floor mounted lowboy type effective in perimeter zone.**



**Supports various types of spaces from office buildings and shop buildings to hospitals.  
Water vapor permeable film humidifier can be installed.  
Remote controller can be installed onto the main unit.**

### Compact unit for easy air conditioning in perimeter zone.

The compact body of 220mm(8-11/16in.) in depth can be easily installed for effective air conditioning in the perimeter zone.

### Electronics dry function dehumidify refreshingly.

Optimum dehumidification depending on indoor temperature to prevent over-cooling. Refreshing dehumidification can be attained.

## ► Specifications

			PFFY-P20VLEM-E	PFFY-P25VLEM-E	PFFY-P32VLEM-E	PFFY-P40VLEM-E	PFFY-P50VLEM-E	PFFY-P63VLEM-E	
Power source			1-phase 220-240V 50Hz / 1-phase 208-230V 60Hz						
Cooling capacity	*1	kW	2.2	2.8	3.6	4.5	5.6	7.1	
	*1	BTU/h	7,500	9,600	12,300	15,400	19,100	24,200	
Heating capacity	*1	kW	2.5	3.2	4.0	5.0	6.3	8.0	
	*1	BTU/h	8,500	10,900	13,600	17,100	21,500	27,300	
Power consumption	Cooling	kW	0.04 / 0.06		0.06 / 0.07	0.065 / 0.075	0.085 / 0.09	0.1 / 0.11	
	Heating	kW	0.04 / 0.06		0.06 / 0.07	0.065 / 0.075	0.085 / 0.09	0.1 / 0.11	
Current	Cooling	A	0.19 / 0.25		0.29 / 0.30	0.32 / 0.33	0.40 / 0.41	0.46 / 0.47	
	Heating	A	0.19 / 0.25		0.29 / 0.30	0.32 / 0.33	0.40 / 0.41	0.46 / 0.47	
External finish(Munsell No.)			Acrylic paint (5Y 8/1)						
Dimension H x W x D	mm		630 x 1,050 x 220			630 x 1,170 x 220		630 x 1,410 x 220	
	in.		24-13/16 x 41-3/8 x 8-11/16			24-13/16 x 46-1/8 x 8-11/16		24-13/16 x 55-9/16 x 8-11/16	
Net weight		kg(lbs.)	23 (51)		25 (56)	26 (58)	30 (67)	32 (71)	
Heat exchanger			Cross fin (Aluminum plate fin and copper tube)						
Fan	Type x Quantity		Sirocco fan x 1			Sirocco fan x 2			
	Airflow rate (Lo-Hi)	*2	m <sup>3</sup> /min	5.5-6.5		7.0-9.0	9.0-11.0	12.0-14.0	12.0-15.5
		L/s	92-108		117-150	150-183	200-233	200-258	
		cfm	194-230		247-318	318-388	424-494	424-547	
External static pressure		Pa	0						
Motor	Type		1-phase induction motor						
	Output		kW	0.015	0.018	0.030	0.035	0.050	
Air filter			PP Honeycomb fabric (washable)						
Refrigerant pipe diameter	Gas (Flare)	mm(in.)	ø12.7 (ø1/2)					ø15.88 (ø5/8)	
	Liquid (Flare)	mm(in.)	ø6.35 (ø1/4)					ø9.52 (ø3/8)	
Field drain pipe diameter		mm(in.)	I.D.26 (1) <Accessory hose O.D.27 (1-3/32) (top end :20 (13/16))>						
Sound pressure level (Lo-Hi)		*2 *3 *4	dB(A)	34-40	35-40	38-43	40-46		

### Notes:

- \*1 Cooling/Heating capacity indicates the maximum value at operation under the following condition.  
Cooling Indoor : 27°C(81°F)DB/19°C(66°F)WB, Outdoor 35°C(95°F)DB  
Heating Indoor : 20°C(68°F)DB, Outdoor 7°C(45°F)DB/6°C(43°F)WB
- \*2 Air flow rate/Sound pressure level are in (Low-High)
- \*3 Measured point : 1m x 1m, Power supply : AC240V/50Hz  
· 1dB(A) lower at AC230V/50Hz  
· 2dB(A) lower at AC220V/50Hz  
· 3dB(A) lower at 1.5m x 1.5m point
- \*4 It is measured in anechoic room.



# INDOOR UNIT

## Floor mounted concealed type

PFFY-P VLRM-E  
PFFY-P VLRMM-E



Neatly installed with pericover concealed.  
Easy installation in perimeter zone.

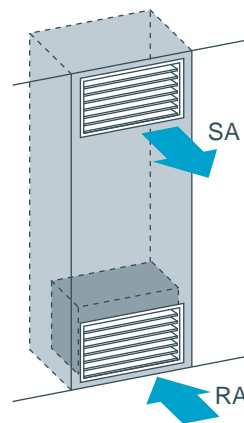

installation image  
(PFFY-P VLRMM-E)

### **Compact unit for easy air conditioning in perimeter zone.**

The body is concealed in the pericover to create harmony with the interior.  
The compact body of 220mm(8-11/16in.) in depth can be easily installed in the perimeter zone.

### **Electronics dry function dehumidify refreshingly to prevent over-cooling.**

Optimum dehumidification depending on indoor temperature to prevent over-cooling.  
Refreshing dehumidification can be attained.

### **Maximum external static pressure 60Pa (VLRMM model)**

The additional external static pressure capacity provides flexibility for duct extension, branching, and air outlet configuration.



## ► Specifications

		PFFY-P20VLRM-E	PFFY-P25VLRM-E	PFFY-P32VLRM-E	PFFY-P40VLRM-E	PFFY-P50VLRM-E	PFFY-P63VLRM-E	
Power source		1-phase 220-240V 50Hz / 1-phase 208-230V 60Hz						
Cooling capacity	*1 kW	2.2	2.8	3.6	4.5	5.6	7.1	
	*1 BTU/h	7,500	9,600	12,300	15,400	19,100	24,200	
Heating capacity	*1 kW	2.5	3.2	4.0	5.0	6.3	8.0	
	*1 BTU/h	8,500	10,900	13,600	17,100	21,500	27,300	
Power consumption	Cooling kW	0.04 / 0.06		0.06 / 0.07	0.065 / 0.075	0.085 / 0.09	0.1 / 0.11	
	Heating kW	0.04 / 0.06		0.06 / 0.07	0.065 / 0.075	0.085 / 0.09	0.1 / 0.11	
Current	Cooling A	0.19 / 0.25		0.29 / 0.30	0.32 / 0.33	0.40 / 0.41	0.46 / 0.47	
	Heating A	0.19 / 0.25		0.29 / 0.30	0.32 / 0.33	0.40 / 0.41	0.46 / 0.47	
External finish(Munsell No.)		Galvanized steel plate						
Dimension H x W x D	mm	639 x 886 x 220		639 x 1,006 x 220		639 x 1,246 x 220		
	in.	25-3/16 x 34-15/16 x 8-11/16		25-3/16 x 39-5/8 x 8-11/16		25-3/16 x 49-1/16 x 8-11/16		
Net weight	kg(lbs.)	18.5 (41)		20 (45)	21 (47)	25 (56)	27 (60)	
Heat exchanger		Cross fin (Aluminum plate fin and copper tube)						
Fan	Type x Quantity	Sirocco fan x 1			Sirocco fan x 2			
	Airflow rate *2 (Lo-Hi)	m <sup>3</sup> /min	5.5-6.5		7.0-9.0	9.0-11.0	12.0-14.0	12.0-15.5
		L/s	92-108		117-150	150-183	200-233	200-258
		cfm	194-230		247-318	318-388	424-494	424-547
External static pressure	Pa	0						
Motor	Type	1-phase induction motor						
	Output kW	0.015		0.018	0.030	0.035	0.050	
Air filter		PP Honeycomb fabric (washable)						
Refrigerant pipe diameter	Gas (Flare) mm(in.)	ø12.7 (ø1/2)					ø15.88 (ø5/8)	
	Liquid (Flare) mm(in.)	ø6.35 (ø1/4)					ø9.52 (ø3/8)	
Field drain pipe diameter	mm(in.)	I.D.26 (1) <Accessory hose O.D.27 (1-3/32) (top end :20 (13/16))>						
Sound pressure level (Lo-Hi)	*2 *3 *4 dB(A)	34-40		35-40	38-43	40-46		

### Notes:

\*1 Cooling/Heating capacity indicates the maximum value at operation under the following condition.  
Cooling Indoor : 27°C(81°F)DB/19°C(66°F)WB, Outdoor 35°C(95°F)DB  
Heating Indoor : 20°C(68°F)DB, Outdoor 7°C(45°F)DB/6°C(43°F)WB

\*2 Air flow rate/Sound pressure level are in (Low-High)

\*3 Measured point : 1m x 1m, Power supply : AC240V/50Hz  
· 1dB(A) lower at AC230V/50Hz  
· 2dB(A) lower at AC220V/50Hz  
· 3dB(A) lower at 1.5m x 1.5m point

\*4 It is measured in anechoic room.

		PFFY-P20VLRMM-E	PFFY-P25VLRMM-E	PFFY-P32VLRMM-E	PFFY-P40VLRMM-E	PFFY-P50VLRMM-E	PFFY-P63VLRMM-E	
Power source		1-phase 220-240V 50Hz / 1-phase 220-240V 60Hz						
Cooling capacity	*1 kW	2.2	2.8	3.6	4.5	5.6	7.1	
	*1 BTU/h	7,500	9,600	12,300	15,400	19,100	24,200	
Heating capacity	*1 kW	2.5	3.2	4.0	5.0	6.3	8.0	
	*1 BTU/h	8,500	10,900	13,600	17,100	21,500	27,300	
Power consumption	Cooling kW	0.04		0.04	0.05	0.05	0.07	
	Heating kW	0.04		0.04	0.05	0.05	0.07	
Current	Cooling A	0.34		0.38	0.43	0.48	0.59	
	Heating A	0.34		0.38	0.43	0.48	0.59	
External finish(Munsell No.)		Galvanized steel plate						
Dimension H x W x D	mm	639 x 886 x 220		639 x 1,006 x 220		639 x 1,246 x 220		
	in.	25-3/16 x 34-15/16 x 8-11/16		25-3/16 x 39-5/8 x 8-11/16		25-3/16 x 49-1/16 x 8-11/16		
Net weight	kg(lbs.)	18.5 (41)		20 (45)	21 (47)	25 (56)	27 (60)	
Heat exchanger		Cross fin (Aluminum plate fin and copper tube)						
Fan	Type x Quantity	Sirocco fan x 1			Sirocco fan x 2			
	Airflow rate (Lo-Mid-Hi)	m <sup>3</sup> /min	4.5-5.5-6.5		6.5-7.5-9.0	8.0-9.5-11.0	10.0-12.0-14.0	11.0-13.0-15.5
		L/s	75-92-108		108-125-150	133-158-183	167-200-233	183-217-258
		cfm	159-194-230		230-265-318	282-335-388	353-424-494	388-459-547
External static pressure *2	Pa	20/40/60						
Motor	Type	DC motor						
	Output kW	0.096						
Air filter		PP Honeycomb fabric (washable)						
Refrigerant pipe diameter	Gas mm(in.)	ø12.7 (ø1/2) Brazed					ø15.88 (ø5/8) Brazed	
	Liquid mm(in.)	ø6.35 (ø1/4) Brazed					ø9.52 (ø3/8) Brazed	
Field drain pipe diameter	mm(in.)	I.D.26 (1) <Accessory hose O.D.27 (1-3/32) (top end :20 (13/16))>						
Sound pressure level (Lo-Mid-Hi)	20Pa dB(A)	31-36-40		27-32-37	30-36-40	32-37-41	35-40-44	
	40Pa dB(A)	34-39-42		30-35-41	32-38-42	35-40-44	36-42-47	
	*3 60Pa dB(A)	35-40-43		32-37-42	35-39-44	36-41-45	38-43-48	

### Notes:

\*1 Cooling/Heating capacity indicates the maximum value at operation under the following condition.  
Cooling Indoor : 27°C(81°F)DB/19°C(66°F)WB, Outdoor 35°C(95°F)DB  
Heating Indoor : 20°C(68°F)DB, Outdoor 7°C(45°F)DB/6°C(43°F)WB  
pipe length : 7.5m(24-9/16ft) Height difference : 0m(0ft)

\*2 The external static pressure is set to 20Pa at factory shipment.

\*3 The sound pressure level in operation is measured at 1m apart from the front side and the bottom side of the unit in anechoic room.  
(Noise meter A-scale value) Connect the duct of 1m in length to the air outlet.



# BC CONTROLLER

CMB-P-V-G1  
 CMB-P-V-GA1  
 CMB-P-V-HA1  
 CMB-P-V-GB1  
 CMB-P-V-HB1

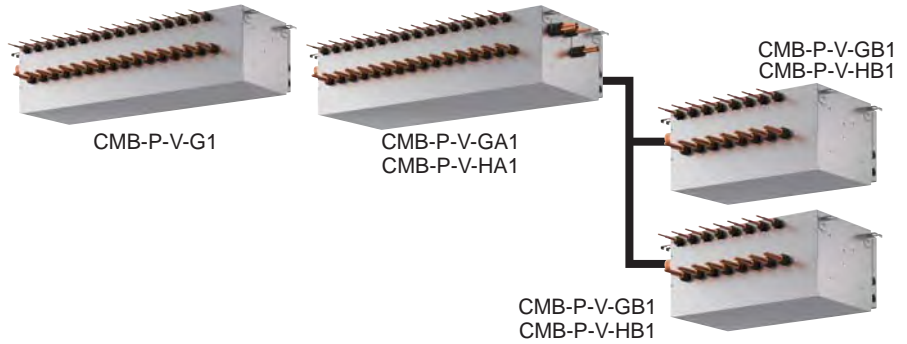

## BC CONTROLLER

In many ways, the BC Controller is the technological heart of the CITY MULTI R2/WR2. It works in unison with the outdoor unit to provide simultaneous cooling and heating, something no other two-pipe system can do. The BC Controller is connected to the outdoor unit by two pipes and to each indoor unit by a series of two refrigerant pipes, depending on the indoor unit count. The BC Controller is required for all CITY MULTI R2-Series installations. It comes in 4, 5, 6, 8, 10, 13, and 16-branch options. The BC Controller you select depends on how many indoor units will be operated from each outdoor unit and your total capacity requirements.

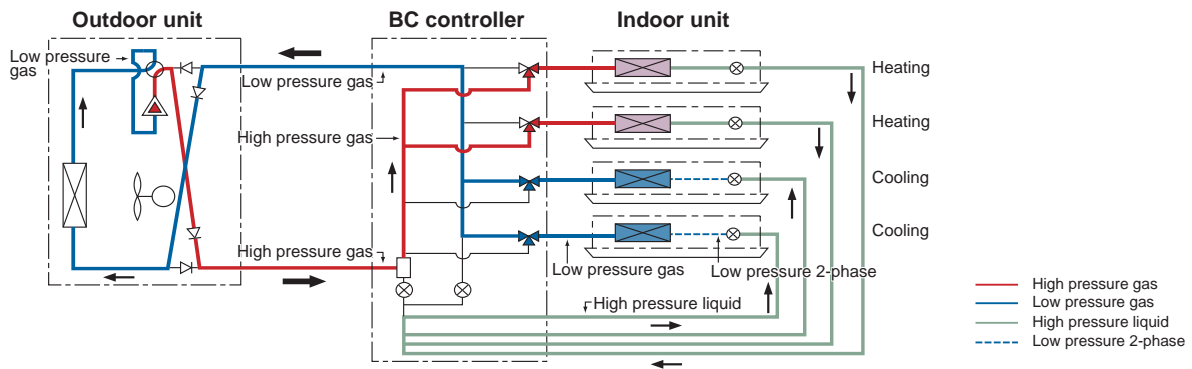

## ► Specifications

Model name		CMB-P104V-G1	CMB-P105V-G1	CMB-P106V-G1	CMB-P108V-G1	CMB-P1010V-G1	CMB-P1013V-G1	CMB-P1016V-G1		
Number of branch		4	5	6	8	10	13	16		
Power source		1-phase 220/230/240V 50Hz/60Hz								
Power input	kW	50Hz	Cooling 0.067/0.076/0.085 heating 0.030/0.034/0.038	0.082/0.093/0.104	0.097/0.110/0.123	0.127/0.144/0.161	0.156/0.177/0.198	0.201/0.228/0.255	0.246/0.279/0.312	
		60Hz	Cooling 0.054/0.061/0.067 heating 0.024/0.027/0.030	0.030/0.034/0.038	0.036/0.041/0.045	0.048/0.054/0.060	0.060/0.068/0.075	0.078/0.088/0.097	0.096/0.108/0.119	
Current	A	50Hz	Cooling 0.31/0.34/0.36 heating 0.14/0.15/0.16	0.18/0.19/0.20	0.21/0.23/0.24	0.28/0.30/0.32	0.35/0.37/0.40	0.45/0.48/0.52	0.55/0.59/0.63	
		60Hz	Cooling 0.25/0.27/0.28 heating 0.11/0.12/0.13	0.30/0.33/0.35	0.36/0.39/0.41	0.47/0.50/0.53	0.58/0.62/0.65	0.74/0.80/0.84	0.90/0.97/1.03	
External finish		Galvanized steel plate (Lower part drain pan painting N1.5)								
Indoor unit capacity connectable to 1 branch		Model P80 or smaller (*Use optional joint pipe combing 2 branches when the total unit capacity exceeds 81.)								
Connectable Outdoor unit ★		Refer to the combination chart of BC controller R2/WR2 series								
Height		mm								
Width		mm								
Depth		mm								
Refrigerant piping diameter	To outdoor unit	Connectable outdoor unit capacity								
		High pressure pipe	P200 ø15.88 (ø5/8) Brazed		P250, P300 ø19.05 (ø3/4) Brazed		P350 ø19.05 (ø3/4) Brazed			
	Low pressure pipe	ø19.05 (ø3/4) Brazed		ø22.2 (ø7/8) Brazed		ø28.58 (ø1-1/8) Brazed				
	To indoor unit	Liquid pipe	Indoor unit Model 50 or smaller:ø6.35 brazed, Over 50:ø9.52 brazed (ø12.7 with optional joint pipe used.)							
Gas pipe	Indoor unit Model 50 or smaller:ø12.7 brazed, Over 50:ø15.88 brazed (ø19.05 with optional joint pipe used.)									
Drain pipe		O. D. 32mm								
Net weight		kg		24	27	28	33	38	45	52
Accessories		•Drain connection pipe (with flexible hose and insulation) •Reducer								

Indoor Unit

# ► Specifications

Model name				CMB-P108V-GA1	CMB-P1010V-GA1	CMB-P1013V-GA1	CMB-P1016V-GA1	CMB-P1016V-HA1
Number of branch				8	10	13	16	
Power source				1-phase 220/230/240V 50Hz/60Hz				
Power input	kW	50Hz	Cooling	0.127/0.144/0.161	0.156/0.177/0.198	0.201/0.228/0.255	0.246/0.279/0.312	
			heating	0.060/0.068/0.076	0.075/0.085/0.095	0.097/0.110/0.123	0.119/0.135/0.151	
	60Hz	Cooling	0.102/0.115/0.127	0.126/0.141/0.156	0.162/0.182/0.201	0.198/0.222/0.246		
		heating	0.048/0.054/0.060	0.060/0.068/0.075	0.078/0.088/0.097	0.096/0.108/0.119		
Current	A	50Hz	Cooling	0.58/0.63/0.68	0.71/0.77/0.83	0.92/1.00/1.07	1.12/1.22/1.30	
			heating	0.28/0.30/0.32	0.35/0.37/0.40	0.45/0.48/0.52	0.55/0.59/0.63	
	60Hz	Cooling	0.47/0.50/0.53	0.58/0.62/0.65	0.74/0.80/0.84	0.90/0.97/1.03		
		heating	0.22/0.24/0.25	0.28/0.30/0.32	0.36/0.39/0.41	0.44/0.47/0.50		
External finish				Galvanized steel plate (Lower part drain pan painting N1.5)				
Indoor unit capacity connectable to 1 branch				Model P80 or smaller (*Use optional joint pipe combing 2 branches when the total unit capacity exceeds 81.)				
Connectable Outdoor unit ★				Refer to the combination chart of BC controller R2/WR2 series				
Height		mm		289				
Width		mm		1,110				
Depth		mm		520				
Refrigerant piping diameter	To outdoor unit	Connectable outdoor unit capacity						
		High pressure pipe	P200	P250,300	P350	P400~P500	P550~P650	P700~P800/P850~P900*4
			ø15.88 (ø5/8) Brazed	ø19.05 (ø3/4) Brazed		ø22.2 (ø7/8) Brazed	ø28.58 (ø1-1/8) Brazed	ø28.58 (ø1-1/8) Brazed/ ø28.58 (ø1-1/8) Brazed
	Low pressure pipe	ø19.05 (ø3/4) Brazed	ø22.2 (ø7/8) Brazed	ø28.58 (ø1-1/8) Brazed			ø34.93 (ø1-3/8) Brazed/ ø41.28 (ø1-5/8) Brazed	
	To indoor unit	Liquid pipe	Indoor unit Model 50 or smaller:ø6.35 brazed, Over 50:ø9.52 brazed (ø12.7 with optional joint pipe used.)					
		Gas pipe	Indoor unit Model 50 or smaller:ø12.7 brazed, Over 50:ø15.88 brazed (ø19.05 with optional joint pipe used.)					
	To another BC controller	Total indoor unit capacity connected to this Sub BC controller						
			~P200	P201~P300	P301~P350	P351~P400	P401~P450	
		High press gas pipe	ø15.88 (ø5/8) Brazed	ø19.05 (ø3/4) Brazed		ø22.2 (ø7/8) Brazed		
		Low press gas pipe	ø19.05 (ø3/4) Brazed	ø22.2 (ø7/8) Brazed	ø28.58 (ø1-1/8) Brazed			
Liquid pipe	ø9.52 (ø3/8) Brazed			ø12.7 (ø1/2) Brazed		ø15.88 (ø5/8) Brazed		
Drain pipe				O.D. 32mm				
Net weight		kg		43	48	55	62	69
Accessories				*Drain connection pipe (with flexible hose and insulation) *Reducer				

Model name				CMB-P104V-GB1	CMB-P108V-GB1	CMB-P1016V-HB1	
Number of branch				4	8	16	
Power source				1-phase 220/230/240V 50Hz/60Hz			
Power input	kW	50Hz	Cooling	0.060/0.068/0.076	0.119/0.135/0.151	0.237/0.269/0.301	
			heating	0.030/0.034/0.038	0.060/0.068/0.076	0.119/0.135/0.151	
	60Hz	Cooling	0.048/0.054/0.060	0.096/0.108/0.119	0.192/0.216/0.237		
		heating	0.024/0.027/0.030	0.048/0.054/0.060	0.096/0.108/0.120		
Current	A	50Hz	Cooling	0.28/0.30/0.32	0.55/0.59/0.63	1.08/1.17/1.26	
			heating	0.14/0.15/0.16	0.28/0.30/0.32	0.55/0.59/0.63	
	60Hz	Cooling	0.22/0.24/0.25	0.44/0.47/0.50	0.88/0.94/0.99		
		heating	0.11/0.12/0.13	0.22/0.24/0.25	0.44/0.47/0.50		
External finish				Galvanized steel plate (Lower part drain pan painting N1.5)			
Indoor unit capacity connectable to 1 branch				Model P80 or smaller (*Use optional joint pipe combing 2 branches when the total unit capacity exceeds 81.)			
Connectable Outdoor unit ★				Refer to the combination chart of BC controller R2/WR2 series			
Height		mm		284			
Width		mm		648			
Depth		mm		432			
Refrigerant piping diameter	To Main BC controller	Total indoor unit capacity connected this Sub BC controller					
			~P200, P201~P350	~P200, P201~P450			
			~P200	P201~P300	P301~P350	P351~P400	P401~P450
	High pressure pipe	ø15.88 (ø5/8) Brazed	ø19.05 (ø3/4) Brazed		ø22.2 (ø7/8) Brazed		
		ø19.05 (ø3/4) Brazed	ø22.2 (ø7/8) Brazed	ø28.58 (ø1-1/8) Brazed			
	Low pressure pipe	ø19.05 (ø3/4) Brazed	ø22.2 (ø7/8) Brazed		ø28.58 (ø1-1/8) Brazed		
	Liquid pipe	ø9.52 (ø3/8) Brazed			ø12.7 (ø1/2) Brazed		ø15.88 (ø5/8) Brazed
	To indoor unit	Liquid pipe	Indoor unit Model 50 or smaller:ø6.35 brazed, Over 50:ø9.52 brazed (ø12.7 with optional joint pipe used.)				
		Gas pipe	Indoor unit Model 50 or smaller:ø12.7 brazed, Over 50:ø15.88 brazed (ø19.05 with optional joint pipe used.)				
	Drain pipe				O.D. 32mm		
Net weight		kg		22	32	55	
Accessories				*Drain connection pipe (with flexible hose and insulation) *Reducer			

### ★ Combination chart of BC Controller for R2 series

	P200,250,300,350	P400-650	P700-900
CMB-P V-G1	○	X	X
CMB-P V-GA1	○	○	X
CMB-P V-HA1	X	X	○
CMB-P V-GB1	○	○	○
CMB-P V-HB1	○	○	○

### ★ Combination chart of BC Controller for WR2 series

	P200,250,300	P400,450,500,550,600
CMB-P V-G1	○	X
CMB-P V-GA1	○	○
CMB-P V-HA1	X	X
CMB-P V-GB1	○	○
CMB-P V-HB1	○	○

#### Notes:

- The equipment is for R410A refrigerant.
- Install this product in a location where noise (refrigerant noise) emitted by the unit will not disturb the neighbors. (For use in quiet environments with low background noise, position the BC CONTROLLER at least 5 m away from any indoor units.)
- Indoor units P100, P125, P140 can be connected to 1 branch. (In this case, cooling capacity decrease a little.)
- When using an outdoor unit – 28HP (P700) or more, use CMB-P1016V-HA1.

- For sub BC controller CMB-P-B-GB1 the connectable indoor unit capacities may sum to equal that of a P350 unit or less. However, if two sub controllers are used the TOTAL sum of connectable units connected to BOTH sub controllers must also not exceed that a P350 unit. For sub BC controller CMB-P-1016V-HB1 the connectable indoor unit capacities may sum to equal that of a P350 unit or less. However, if two sub controllers are used the TOTAL sum of connectable units connected to BOTH sub controllers must also not exceed that a P450 unit.



# Air to Water series

---

PWFY-P100VM-E-BU  
PWFY-P100VM-E1-AU  
PWFY-P200VM-E1-AU

## Air to Water advanced system explained

Air To Water (ATW) series offers the choice between two types of units; a Booster unit and a HEX (Heat Exchanger) unit. A Booster unit offers hot water to a maximum of 70°C and HEX unit offers 45°C in heating and down to 8°C in cooling. Applying heat pump and heat recovery technology to provide hot water, the units are suitable for residences, office buildings, restaurants or hotels, providing an optimal environment while being cost effective and a reduced impact on the environment.

ATW system consists of an outdoor unit, a BC controller when connected with R2 series, ATW unit, indoor unit and a controller.

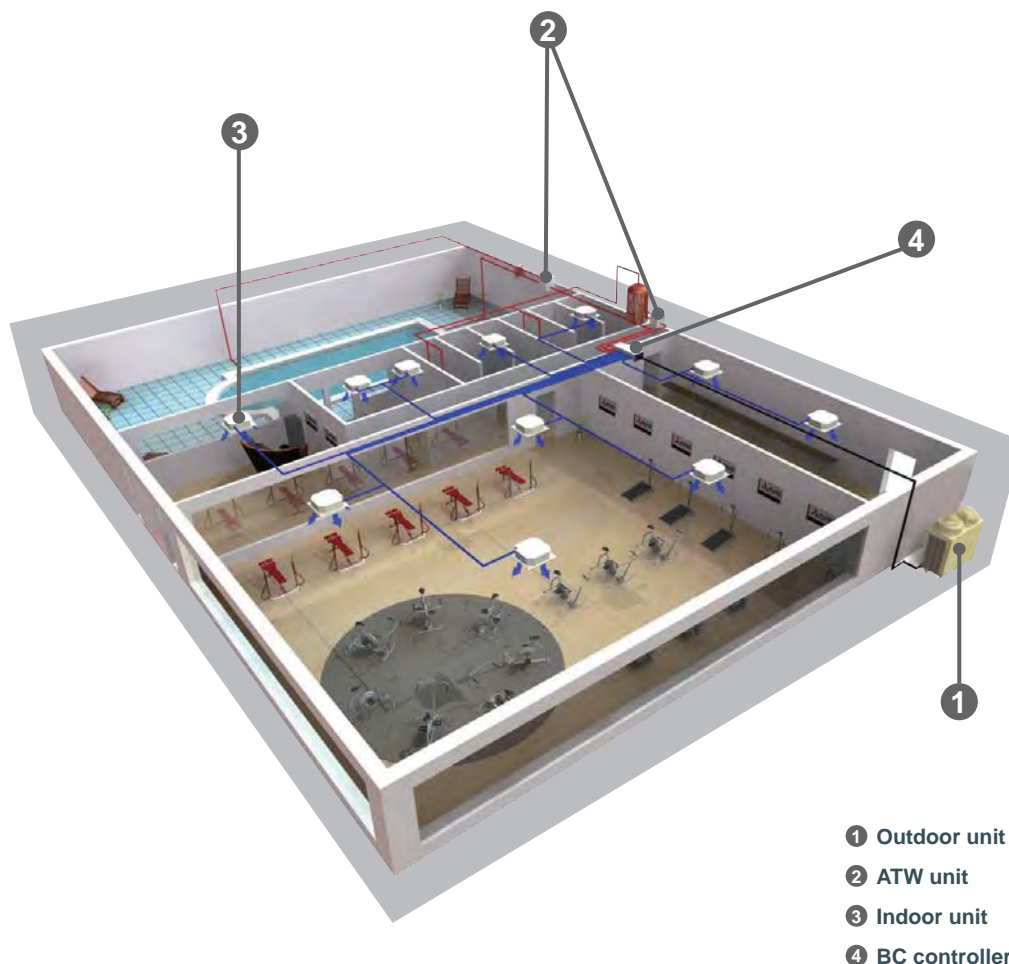

## Line Up

### 1 ATW UNIT

#### BOOSTER UNIT

Benefiting from the heat recovery operation of the CITY MULTI R2 system, Booster unit converts energy from the air to higher temperatures suitable for supplying hot water and results in virtually no energy waste.



**PWFY-P100VM-E-BU**

#### Connectable to

CITY MULTI  
R2/WR2 series  
REPLACE MULTI  
R2 series

#### Applications

best for sanitary  
water, shower, etc.

#### Operation

up to 70°C

#### SYSTEM OUTLINE

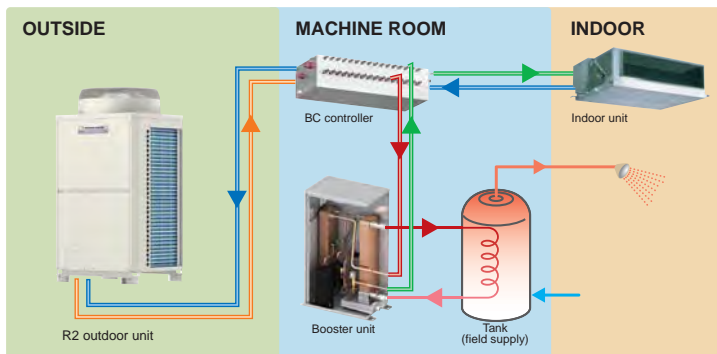

The Booster unit is connected to a BC controller with refrigerant pipes, and to the water tank with water pipes. The waste heat from cooling operation is utilised for heating operation which provides hot water.

- Red — High pressure gas refrigerant
- Orange — High pressure 2-phase refrigerant
- green — High pressure liquid refrigerant
- Blue — Low pressure gas refrigerant

## What makes the Booster unit unique?

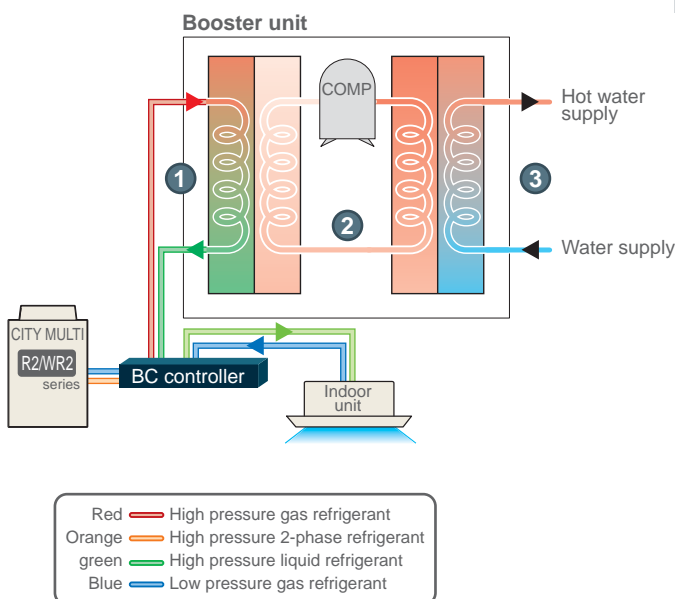

- Red — High pressure gas refrigerant
- Orange — High pressure 2-phase refrigerant
- green — High pressure liquid refrigerant
- Blue — Low pressure gas refrigerant

#### Refrigerant flow

- 1 From the BC controller, high pressure R410A gas refrigerant is delivered to the Booster unit to exchange heat with the low pressure R134a liquid refrigerant circulating through 2 and returns to the BC controller as a high pressure liquid refrigerant.
- 2 Refrigerant R134a circulates inside the two plate heat exchangers inside the unit. Temperature rises as low-pressure R134a gas refrigerant is compressed by the compressor and becomes high-pressure gas refrigerant.

#### Water supply

- 3 Water entering the Booster unit exchanges heat with high-pressure R134a gas refrigerant. The hot water circulates to heat the water inside the tank which will be used for showers, sanitary water, etc.



# HEX UNIT

By utilising waste heat from the R2 outdoor unit for heating operation in HEX unit, it is possible to supply hot water with high efficiency. Even when connected with the Y series, it provides efficient operation compared to a conventional system.



**PWFY-P100VM-E1-AU**  
**PWFY-P200VM-E1-AU**

### Connectable to

CITY MULTI  
R2/WR2/  
Y/WY/ZUBADAN series  
S series  
REPLACE MULTI  
R2/Y series

### Applications

best for floor heating, panel heater, fan-coil unit(AHU), etc.

### Operation

hot water up to 45°C  
cold water down to 8°C

### SYSTEM OUTLINE HEX unit with R2 series

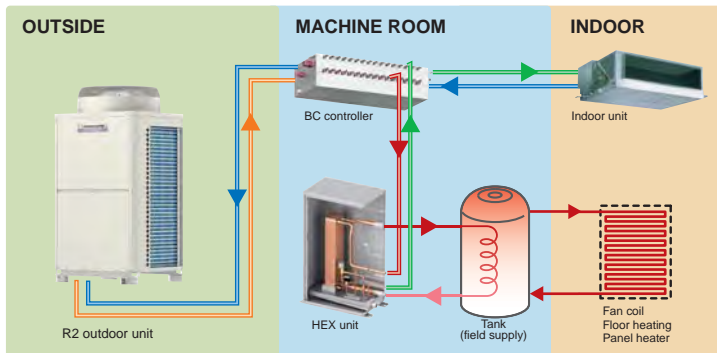

HEX unit is connected to BC controller with refrigerant pipes, and to the water tank with water pipes. HEX unit is not equipped with a compressor.

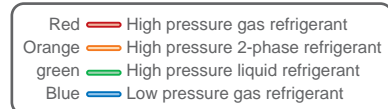

\*The image is a system example in case of heating mode.  
\*The necessity of the tank depends on the system configuration.

## What makes HEX unit unique with R2/WR2 series?

### Hot water supply

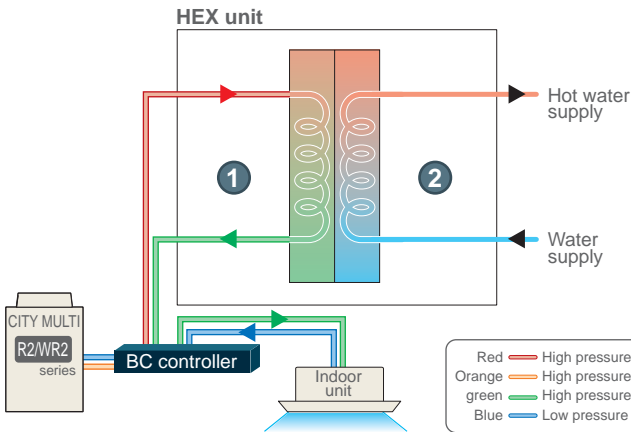

### Refrigerant flow

- 1 From the BC controller, high pressure R410A gas refrigerant is delivered to the HEX unit and returns to the unit as high pressure liquid refrigerant.

### Water supply

- 2 Water entering the HEX unit exchanges heat with the R410A refrigerant and water circulates to heat the water inside the tank.

### Cold water supply

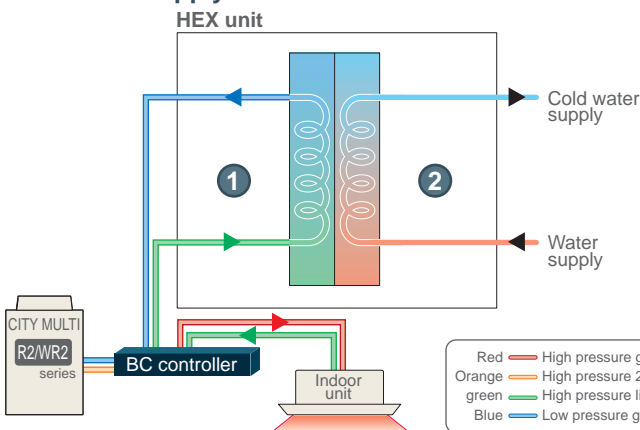

### Refrigerant flow

- 1 From the BC controller, high pressure R410A liquid refrigerant is delivered to the HEX unit and returns to the unit as low pressure gas refrigerant.

### Water supply

- 2 Water entering the HEX unit exchanges heat with the R410A refrigerant and water circulates to cool the water inside the tank.

Indoor Unit

### SYSTEM OUTLINE HEX unit with Y series

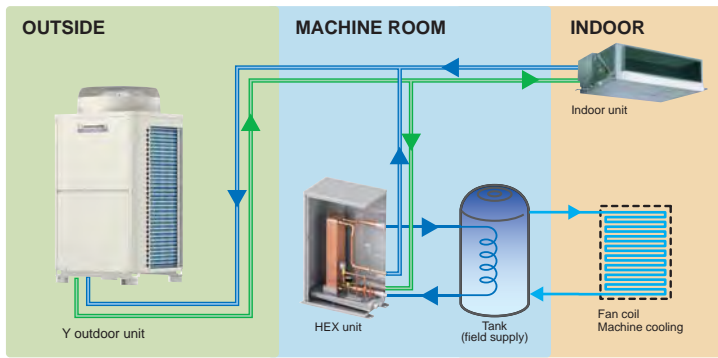

HEX unit is connected to Y outdoor unit with refrigerant pipes, and to the water tank with water pipes. HEX unit is not equipped with a compressor.

Red	High pressure gas refrigerant
Orange	High pressure 2-phase refrigerant
green	High pressure liquid refrigerant
Blue	Low pressure gas refrigerant

## What makes HEX unit unique with Y/WY series?

### Hot water supply

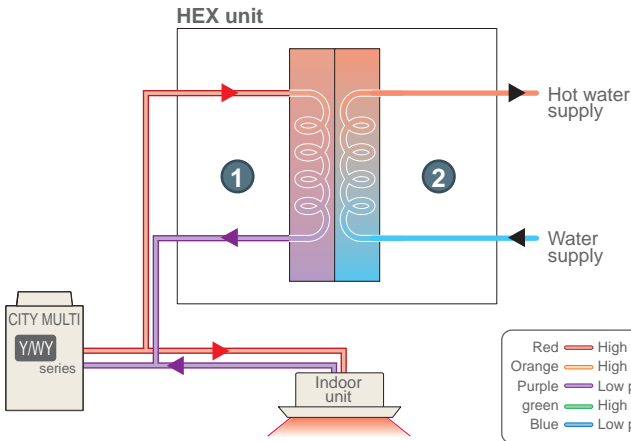

#### Refrigerant flow

- From the outdoor unit, high pressure R410A gas refrigerant is delivered to the HEX unit and returns to the unit as low pressure 2-phase refrigerant.

#### Water supply

- Water entering the HEX unit exchanges heat with the R410A refrigerant and water circulates to heat the water inside the tank.

Red	High pressure gas refrigerant
Orange	High pressure 2-phase refrigerant
Purple	Low pressure 2-phase refrigerant
green	High pressure liquid refrigerant
Blue	Low pressure gas refrigerant

### Cold water supply

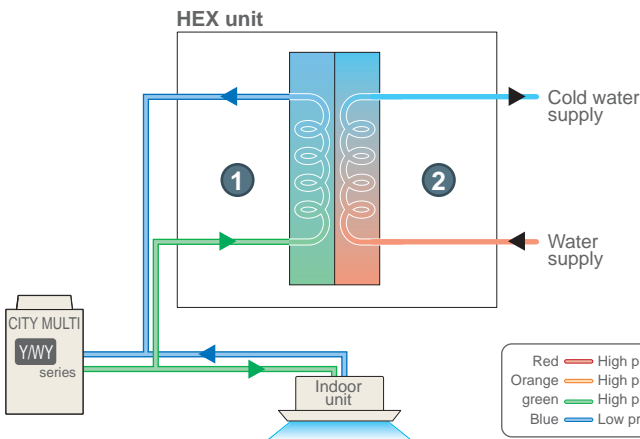

#### Refrigerant flow

- From the outdoor unit, high pressure R410A liquid refrigerant is delivered to the HEX unit and returns to the unit as low pressure gas refrigerant.

#### Water supply

- Water entering the HEX unit exchanges heat with the R410A refrigerant and water circulates to cool the water inside the tank.

Red	High pressure gas refrigerant
Orange	High pressure 2-phase refrigerant
green	High pressure liquid refrigerant
Blue	Low pressure gas refrigerant



## ② BC CONTROLLER

To connect R2/WR2 series outdoor units and ATW indoor units, a BC controller will be used.

		BC controller
Connectable ATW system		Booster/HEX
Outdoor unit	Connectable series	R2*/WR2
	Connectable capacity	P200-P900
ATW/ Indoor unit	Connectable qty	1-50
	Connection method	With BC's port
	Operation mode	Cooling AND heating
Product image		

### CASE STUDY

Application : Apartments

Country : Australia



#### Unit information

Outdoor unit : Air-cooled R2 series x 3, BC controller x 3

ATW unit : Booster unit x3 Indoor unit : Ceiling coneaed type x11, Ceiling cassette type x9

Control : AG-150A x1, ATW controller x 3, PAR-30MAA x20, Power supply unit x 1

#### ●Background

The mid town apartments required air conditioning, fresh air, and sanitary water. As a perfect solution that can provide all three, the consultant proposed the Air to Water system+CITY MULTI+OA processing unit.

With the combination of Mitsubishi Electric's product lineup, the system can provide hot water without a boiler and air conditioning with a high COP. Whats more, with the OA processing unit in a system, suitable ventilation with top quality air and energy saving environment is created.



# ATW UNIT

## Booster Unit

### PWFY-P VM-E-BU



## ► Specifications

Model		PWFY-P100VM-E-BU	
Power source		1-phase 220-230-240V 50 / 60Hz	
Heating capacity (Nominal)	*1 kW	12.5	
	*1 kcal/h	10,800	
	*1 BTU/h	42,700	
	Power input	kW	
Current input	A		
Temp. range of heating	Outdoor unit/Heat source unit condition	W.B.	-20~32°C (-4~90°F) R2-series
	Booster unit inlet water temp.	-	10~45°C (50~113°F) WR2-series
		-	10~70°C (50~158°F)
Connectable outdoor unit/heat source unit	Total capacity	50~100% of outdoor unit/heat source unit capacity	
	Model / Quantity	R2 (Standard, Hi-COP), Replace R2, WR2 series only	
Sound pressure level (measured in anechoic room)		dB<A>	
		44	
Diameter of refrigerant pipe	Liquid	mm(in.)	ø9.52 (ø3/8") Braze
	Gas	mm(in.)	ø15.88 (ø5/8") Braze
Diameter of water pipe	Inlet	mm(in.)	PT3/4 Screw
	Outlet	mm(in.)	PT3/4 Screw
Field drain pipe size	mm(in.)	ø32 (1-1/4")	
External finish		NO	
External dimension H x W x D	mm	800 (785 without legs) x 450 x 300	
	in.	31-1/2" (30-15/16" without legs) x 17-3/4" x 11-13/16"	
Net weight	kg(lbs)	60 (133)	
Compressor	Type	Inverter rotary hermetic compressor	
	Maker	MITSUBISHI ELECTRIC CORPORATION	
	Starting method	Inverter	
	Motor output	kW	1.0
	Lubricant	NEO22	
Circulating water	Operation volume Range	m³/h	0.6~2.15
Protection on internal circuit (R134a)	High pressure protection	High pressure sensor, High pressure switch at 3.60 MPa (601 psi)	
	Inverter circuit (COMP)	Over - heat protection, Over - current protection	
	Compressor	Discharge thermo protection, Over - current protection	
Refrigerant	Type x original charge	*2	R134a x 1.1kg (0.50lb)
	Control	LEV	
Design pressure	R410A	MPa	4.15
	R134a	MPa	3.60
	Water	MPa	1.00
Drawing	External	WKB94L762	
	Wiring	WKE94C229	
Standard attachment	Document	Installation Manual, Instruction Book	
	Accessory	Strainer, Heat insulation material, 2 x Connector sets	
Optional parts	NONE		
Remark	Details on foundation work, duct work, insulation work, electrical wiring, power source switch, and other items shall be referred to the Installation Manual.		

### Notes:

\*1 Nominal heating conditions

<R2-series>

Outdoor Temp. : 7°CDB/6°CWB (45°FDB / 43°FWB)  
 Pipe length : 7.5 m (24-9/16 ft)  
 Level difference : 0m (0ft)  
 Inlet water Temp 65°C Water flow rate 2.15m³/h

<WR2-series>

Circulating water Temp. : 20°C (68°F)  
 Pipe length : 7.5 m (24-9/16 ft)  
 Level difference : 0m (0ft)  
 Inlet water Temp 65°C Water flow rate 2.15m³/h

\*2 Do not use refrigerant other than the type indicated in the manuals provided with the unit and on the nameplate.

- Doing so may cause the unit or pipes to burst, or result in explosion or fire during use, during repair, or at the time of disposal of the unit.
- It may also be in violation of applicable laws.
- MITSUBISHI ELECTRIC CORPORATION cannot be held responsible for malfunctions or accidents resulting from the use of the wrong type of refrigerant.

\* Due to continuing improvement, the above specifications may be subject to change without notice.

\* The unit is not designed for outside installations.

\* Please don't use the steel material for the water piping material.

\* Please always make water circulate or add the brine to the circulation water when the ambient temperature becomes 0°C (32°F) or less.

\* Please always make water circulate or pull out the circulation water completely when not using it.

\* Please do not use groundwater and well water.

\* Install the unit in an environment where the wet bulb Temp. will not exceed 32°C (90°F).

\* The water circuit must use the closed circuit.

\* Please do not use it as a drinking water.



# ATW UNIT

## HEX Unit

### PWFY-P VM-E1-AU



## ► Specifications

Model			PWFY-P100VM-E1-AU	PWFY-P200VM-E1-AU	
Power source			1-phase 220-230-240V 50 / 60Hz	1-phase 220-230-240V 50 / 60Hz	
Heating capacity (Nominal)	*1	kW	12.5	25.0	
	*1	kcal/h	10,800	21,500	
	*1	BTU/h	42,700	85,300	
	Power input		kW	0.015	0.015
	Current input		A	0.068-0.065-0.063	0.068-0.065-0.063
Temp. range of heating	Outdoor unit/ Heat source unit condition	W.B.	-15~15°C (5~60°F) S - series	-	
		W.B.	-20~15.5°C (-4~60°F) Y - series	-20~15.5°C (-4~60°F) Y - series	
		W.B.	-25~15.5°C (-13~60°F) HP(ZUBADAN) - series	-25~15.5°C (-13~60°F) HP(ZUBADAN) - series	
		W.B.	-20~32°C (-4~90°F) R2 - series	-20~32°C (-4~90°F) R2 - series	
		-	10~45°C (50~113°F) WY - series	10~45°C (50~113°F) WY - series	
	-	10~45°C (50~113°F) WR2 - series	10~45°C (50~113°F) WR2 - series		
	HEX unit inlet water temp.		-	10~45°C (50~104°F) Y, HP(ZUBADAN), R2, WY, WR2 - series	10~40°C (50~104°F)
Cooling capacity (Nominal)	*2	kW	11.2	22.4	
	*2	kcal/h	9,600	19,300	
	*2	BTU/h	38,200	76,400	
	Power input		kW	0.015	0.015
	Current input		A	0.068-0.065-0.063	0.068-0.065-0.063
Temp. range of cooling	Outdoor unit/ Heat source unit condition	D.B.	-5~46°C (23~115°F) Y - series	-5~46°C (23~115°F) Y - series	
		D.B.	-5~43°C (23~110°F) HP(ZUBADAN) - series	-5~43°C (23~110°F) HP(ZUBADAN) - series	
		D.B.	-5~46°C (23~115°F) R2 - series	-5~46°C (23~115°F) R2 - series	
		-	10~45°C (50~113°F) WY - series	10~45°C (50~113°F) WY - series	
		-	10~45°C (50~113°F) WR2 - series	10~45°C (50~113°F) WR2 - series	
HEX unit inlet water temp.		-	10~35°C (50~95°F)	10~35°C (50~95°F)	
Connectable outdoor unit/heat source unit	Total capacity		50~100% of outdoor unit/heat source unit capacity	50~100% of outdoor unit/heat source unit capacity	
	Model / Quantity		Y (Standard, Hi-COP), Replace Y, S, HP(ZUBADAN) series, R2 (Standard, Hi-COP), Replace R2, WY series, WR2 series	Y (Standard, Hi-COP), Replace Y, HP(ZUBADAN) series, R2 (Standard, Hi-COP), Replace R2, WY series, WR2 series	
Sound pressure level (measured in anechoic room)		dB<A>	29	29	
Diameter of refrigerant pipe	Liquid	mm(in.)	ø9.52 (ø3/8") Brazed	ø9.52 (ø3/8") Brazed	
	Gas	mm(in.)	ø15.88 (ø5/8") Brazed	ø19.05 (ø3/4") Brazed	
Diameter of water pipe	Inlet	mm(in.)	PT3/4 Screw	PT 1 Screw	
	Outlet	mm(in.)	PT3/4 Screw	PT 1 Screw	
Field drain pipe size		mm(in.)	ø32 (1-1/4")	ø32 (1-1/4")	
External finish			NO	NO	
External dimension H x W x D		mm	800 (785 without legs) x 450 x 300	800 (785 without legs) x 450 x 300	
		in.	31-1/2" (30-15/16" without legs) x 17-3/4" x 11-13/16"	31-1/2" (30-15/16" without legs) x 17-3/4" x 11-13/16"	
Net weight		kg(lbs)	35 (78)	38 (84)	
Circulating water	Operation Volume Range		m³/h	1.1~2.15	1.8~4.30
	R410A	MPa	4.15	4.15	
Design pressure	Water		MPa	1.00	1.00
	External			KD94R274	KD94R274
Drawing	Wiring			WKE94C626	WKE94C626
	Document		Installation Manual, Instruction Book		
Standard attachment	Accessory		Strainer, Heat insulation material, 2 x Connector sets, Flow switch x 1 set, wire		
			Strainer, Connector, Heat insulation material, 2 x Connector sets, Expansion joint, Flow switch x 1 set, wire		
Optional parts			Solenoid valve kit: PAC-SV01PW-E	Solenoid valve kit: PAC-SV01PW-E	
Remark			Details on foundation work, duct work, insulation work, electrical wiring, power source switch, and other items shall be referred to the Installation Manual.		

### Notes:

\*1 Nominal heating conditions  
<S/Y/HP(ZUBADAN)/R2-series>  
Outdoor Temp. : 7°CDB/6°CWB (45°FDB / 43°FWB)  
Pipe length : 7.5 m (24-9/16 ft)  
Level difference : 0m (0ft)  
Inlet water Temp 30°C  
Water flow rate 2.15m³/h(P100), 4.30m³/h(P200)

<WY/WR2-series>  
Circulating water Temp. : 20°C (68°F)  
Pipe length : 7.5 m (24-9/16 ft)  
Level difference : 0m (0ft)  
Inlet water Temp 30°C  
Water flow rate 2.15m³/h(P100), 4.30m³/h(P200)

\*2 Nominal cooling conditions  
<Y/HP(ZUBADAN)/R2-series>  
Outdoor Temp. : 35°CDB (95°FDB)  
Pipe length : 7.5 m (24-9/16 ft)  
Level difference : 0m (0ft)  
Inlet water Temp 23°C  
Water flow rate 1.93m³/h(P100), 3.86m³/h(P200)

<WY/WR2-series>  
Circulating water Temp. : 30°C (86°F)  
Pipe length : 7.5 m (24-9/16 ft)  
Level difference : 0m (0ft)  
Inlet water Temp 23°C  
Water flow rate 1.93m³/h(P100), 3.86m³/h(P200)

- \* Due to continuing improvement, the above specifications may be subject to change without notice.
- \* The unit is not designed for outside installations.
- \* Please don't use the steel material for the water piping material.
- \* Please always make water circulate or add the brine to the circulation water when the ambient temperature becomes 0°C (32°F) or less.
- \* Please always make water circulate or pull out the circulation water completely when not using it.
- \* Please do not use groundwater and well water.
- \* Install the unit in an environment where the wet bulb Temp. will not exceed 32°C (90°F).
- \* The water circuit must use the closed circuit.
- \* Please do not use it as a drinking water.

Indoor Unit

# Controller Remote Controller PAR-W21MAA



## ► Specifications

○ : Each group    × : Not available

Item	Description	Operations	Display
ON / OFF	Runs and stops the operation of a group of units	○	○
Operation mode switching	Switches between Hot Water / Heating / Heating ECO / Anti - freeze / Cooling * Available operation modes vary depending on the unit to be connected. * Switching limit setting can be made via a remote controller.	○	○
Water temperature setting	Temperature can be set within the ranges below. (in increments of 1°C or 1°F) Heating      30°C ~ 50°C Heating ECO 30°C ~ 45°C Hot Water    30°C ~ 70°C Anti-freeze   10°C ~ 45°C Cooling      10°C ~ 30°C * The settable range varies depending on the unit to be connected.	○	○
Preset temperature range limit	Preset temperature range setting can be limited via a remote controller.	○	○
Water temperature display	10°C ~ 90°C (in increments of 1°C or 1°F) * The settable range varies depending on the unit to be connected.	×	○
Permit / Prohibit local operation	Individually prohibits operations of each local remote control function : ON / OFF, Operation modes, water temperature setting, Circulating water replacement warning reset. * Upper level controller may not be connected depending on the unit to be connected.	×	○
Schedule operation	ON / OFF / Water temperature setting can be done up to 6 times one day in the week. (in increments of a minute)	○	○
Error display	When an error is currently occurring on a unit, the afflicted unit and the error code are displayed.	×	○
Self check (Error history)	Searches the latest error history by pressing the CHECK button twice.	○	○
Test run	Enables the Test run mode by pressing the TEST button twice. * Test run mode is not available depending on the unit to be connected.	○	○
Circulating water replacement warning	Displays the circulating water replacement warning via the unit message. Clears the display by pressing the CIR.WATER button twice. * Circulating water replacement warning is not available depending on the unit to be connected.	○	○
Operation locking function	Remote controller operation can be locked or unlocked. · All-switch locking · Locking except ON / OFF switch	○	○

## Optional Parts Solenoid Valve kit

Note:

When you intend to adopt PWFY-AU with below system configuration, you may need to use optional part (PAC-SV01PW-E).  
Please contact your Mitsubishi Electric sales office for details.

## Applicable System

System Configuration
Y, HP(ZUBADAN), Replace Y, or WY* + PWFY-AU + Indoor Unit

\*Solenoid valve kit will be used only when operating the WY at the water temperature below 10°C.

## PAC-SV01PW-E

Item	Description								
Power source	1-phase 220-230-240V 50 / 60Hz								
Diameter of refrigerant pipe	Applicable models								
	<table border="1"> <thead> <tr> <th></th> <th>PWFY-P100VM-E1-AU</th> <th>PWFY-P200VM-E1-AU</th> </tr> </thead> <tbody> <tr> <td>Liquid</td> <td>ø15.88</td> <td>ø19.05</td> </tr> <tr> <td>Gas</td> <td>ø9.52</td> <td>ø9.52</td> </tr> </tbody> </table>		PWFY-P100VM-E1-AU	PWFY-P200VM-E1-AU	Liquid	ø15.88	ø19.05	Gas	ø9.52
	PWFY-P100VM-E1-AU	PWFY-P200VM-E1-AU							
Liquid	ø15.88	ø19.05							
Gas	ø9.52	ø9.52							
External dimension H × W × D	mm								
	in.								
Net weight	kg (lbs)								
Drawing	WKD94T532								
Standard attachment	Document								
	Accessory								



## RX5 SERIES



### The Ventilation System for Enhanced Air Quality - Lossnay

Combine with Lossnay Ventilation System Enhanced Air Quality.  
Unified Control System Allows Greater Design Freedom.

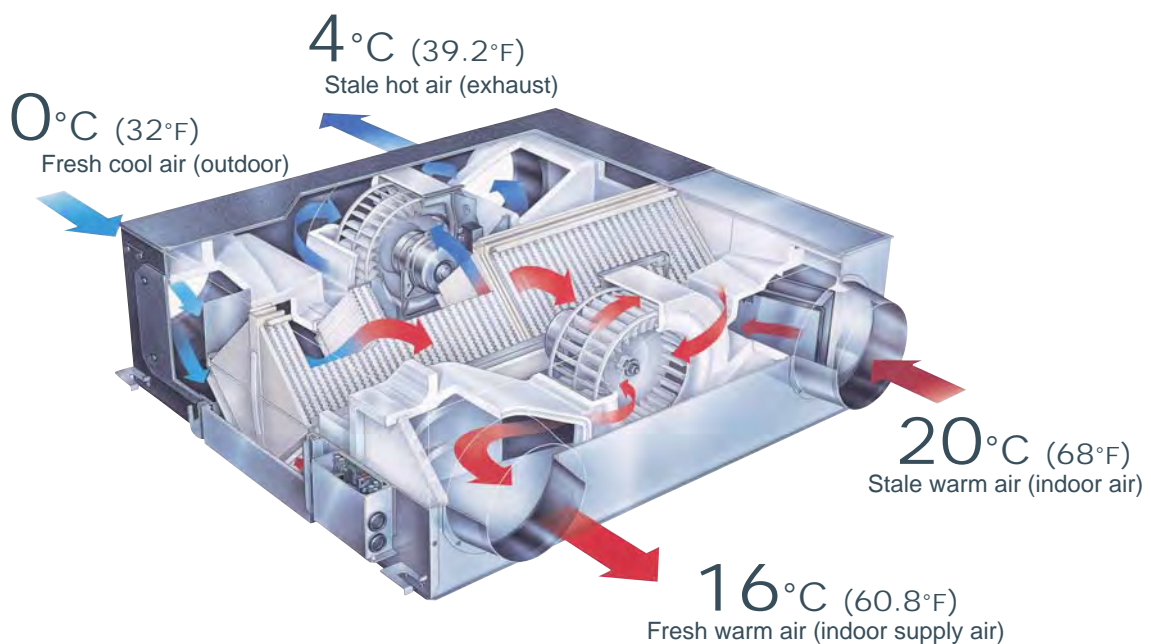

**LGH-15RX5** [150m<sup>3</sup>/h Single phase 220-240V 50Hz]  
**LGH-25RX5** [250m<sup>3</sup>/h Single phase 220-240V 50Hz]  
**LGH-35RX5** [350m<sup>3</sup>/h Single phase 220-240V 50Hz]  
**LGH-50RX5** [500m<sup>3</sup>/h Single phase 220-240V 50Hz]  
**LGH-65RX5** [650m<sup>3</sup>/h Single phase 220-240V 50Hz]

**LGH-80RX5** [800m<sup>3</sup>/h Single phase 220-240V 50Hz]  
**LGH-100RX5** [1000m<sup>3</sup>/h Single phase 220-240V 50Hz]  
**LGH-150RX5** [1500m<sup>3</sup>/h Single phase 220-240V 50Hz]  
**LGH-200RX5** [2000m<sup>3</sup>/h Single phase 220-240V 50Hz]

### Heat-Exchange Efficiency Obtainable Only with Lossnay.

The secret to the unmatched comfort provided by Lossnay core is the cross-flow, plate-fin structure of the heat-exchange unit. A diaphragm made of a specially processed paper fully separates inducted and exhausted air supplies, ensuring that only fresh air is introduced to the indoor environment.

The superior heat-transfer and moisture permeability of the special paper assure highly effective total heat exchange (temperature and humidity) when inducted and exhausted air supplies cross in the Lossnay core.

# LOSSNAY Technology

- **Two paths ventilation**  
LOSSNAY simultaneously intakes Fresh Air and exhausts dirty Air.
- **Total energy recover**  
LOSSNAY returns BOTH sensible heat and latent heat.

## A. Two paths ventilation

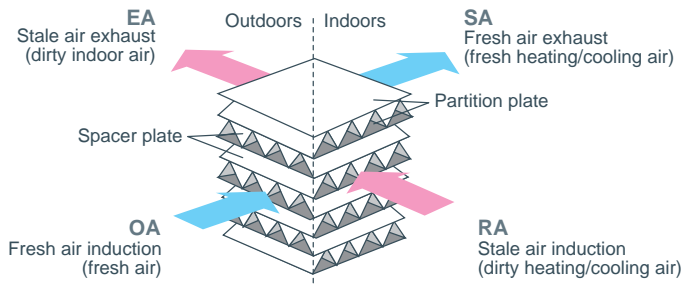

## B. Total Energy transfer

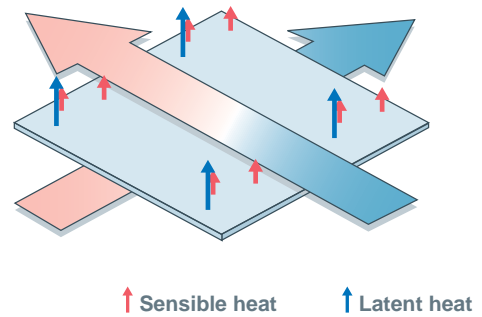

- **Hyper Eco Core**  
Better energy conservation by improved total heat exchange efficiency.

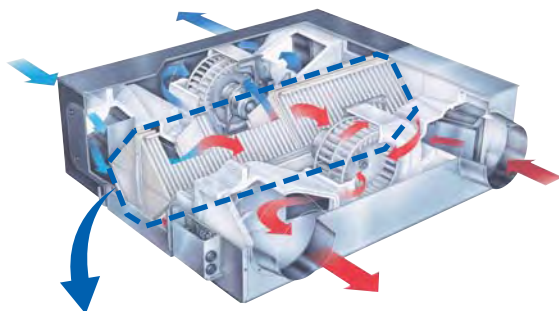

### Hyper Eco Element

Mitsubishi's Hyper Eco Element offers heat exchange efficiency. Energy conservation performance has been improved not only by reducing the air conditioning load associated with ventilation, but also by facilitating humidity penetration.

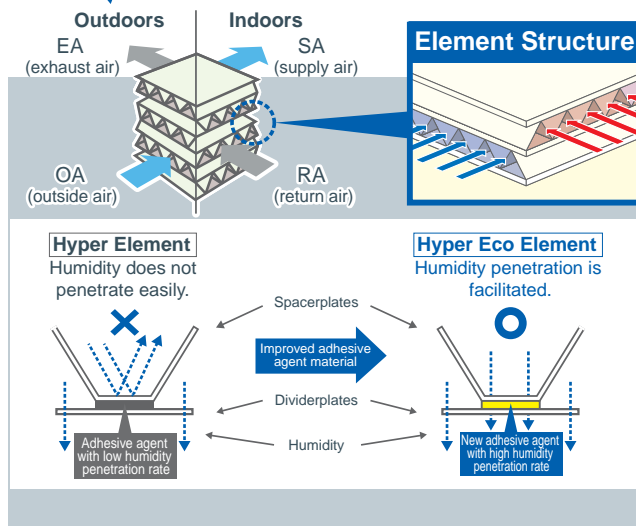

Enthalpy exchange efficiency improve

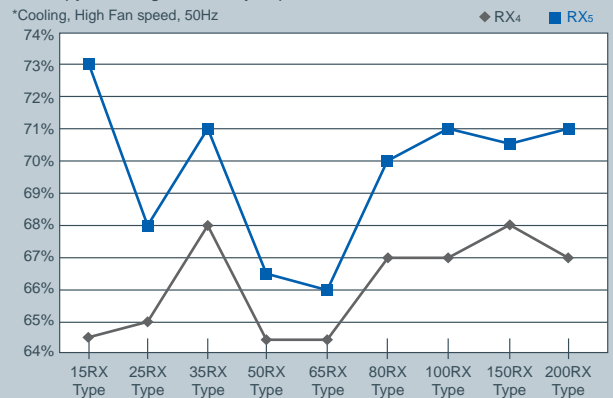

based on Mitsubishi Electric laboratory tests.

## Why LOSSNAY is necessary.

- **Without ventilation...**  
Lack of Ventilation creates dirty indoor air including CO<sub>2</sub>, Dust, Bacteria.
- **If just opening windows...**  
Opening windows eliminates dirty air BUT reduces air-conditioning efficiency.
- **So we recommend LOSSNAY**  
LOSSNAY is simultaneous pursuit of Ventilation and Energy Efficiency.

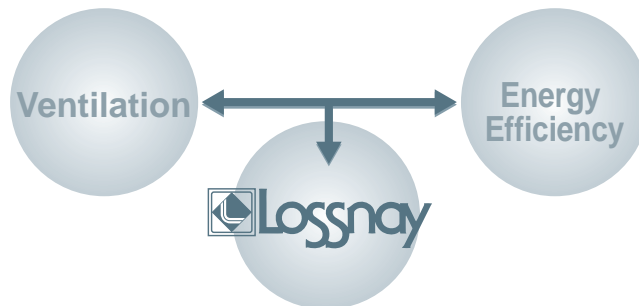

- **This is LOSSNAY !**

### ADVANTAGES

**Clean air supply, dirty air exhaust** by Two air paths (OA → SA and RA → EA)

**Energy recovery** by LOSSNAY Core

**Free cooling** by bypass damper

**MULTI VENTILATION MODE** for multi ventilation request (Power supply, Power supply/exhaust, Power exhaust)

### UNIT STRUCTURE

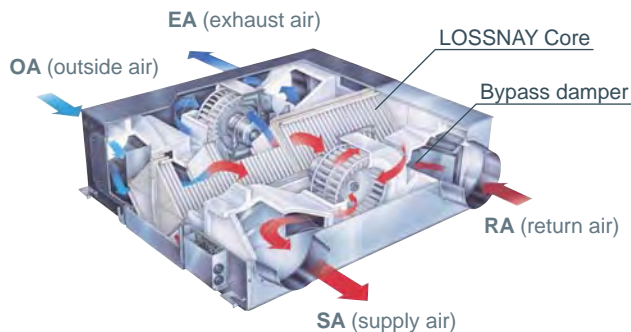

### Energy Recovery Image

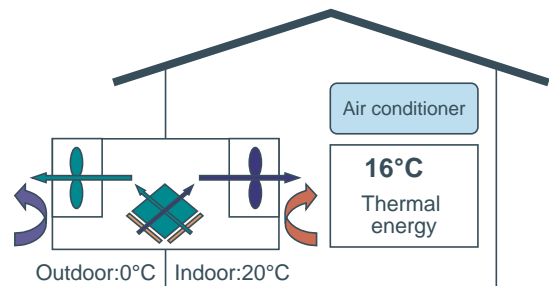

#### How much recovery?

OA temp. : 0°C → SA temp. : 16°C (Indoor 20°C)

## Extra Low Mode

- Additional energy conservation by using a four-level air volume system that allows more precise control.

In addition to the conventional Extra High, High, and Low modes, an Extra Low mode is added to provide a more dynamic range of air volume settings and versatility in a variety of installation environments, yielding much better energy conservation. Using a simplified timer function, it switches to Extra Low operation when the operation stop button is activated and it is accordingly possible to implement 24-hour energy conservation ventilation.

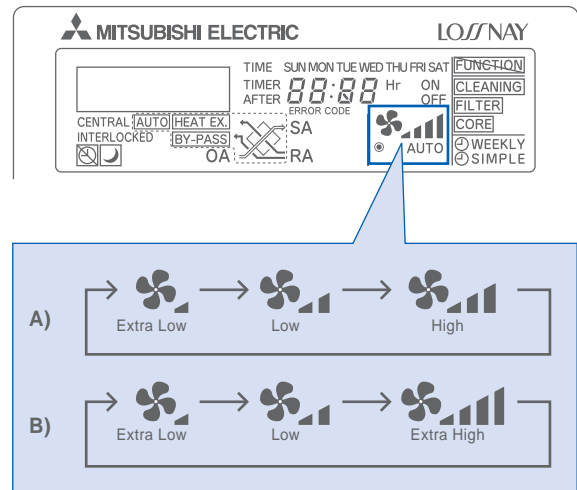

- \* The Extra High and High ventilation modes are selectable by the initial setting.
- \* Extra-Low not equipped LGH-150RXs and 200RXs.
- \* The ventilation mode is actually selected in three levels, and the remote controller also displays these three levels.

## Energy Saving by WEEKLY timer

Air volume level can be set hourly (max 8 times) and weekly. You can pre-set air volume according to the predictable requirement so that LOSSNAY can automatically operate at only necessary air-speed at the specified time period, which saves power consumption while maintaining the indoor air quality. Once the weekly timer has been set, switching on-off is not required.

### Example A (Hourly)

current RX<sub>4</sub> series with PZ-41SLB controller



new RX<sub>5</sub> series with PZ-60DR-E



Total power consumption in one day : LGH-100RX<sub>4</sub>-E : 6,600W (14 hours)  
 LGH-100RX<sub>5</sub>-E : 5,390W (14 hours) → **1,210W (18%) less**

### Example B (Weekly)



## New function: "By-pass" Ventilation External Control Setting

In addition to the automatic damper open/close function, open/close control via external devices is now possible, delivering a "By-pass" ventilation system that is suitable to the installed environment.

### Control devices (example)

- Temperature sensor
- Humidity sensor
- Timers

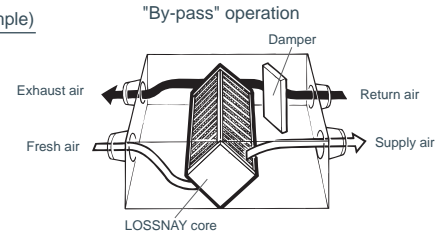

Establish the wire connection by inserting the optional remote display adaptor (PAC-SA88HA-E) in the connector CN16 (Ventilation mode selector).

With SW1 is "ON", the ventilation mode of LOSSNAY is changed to the By-pass ventilation regardless of the setting on the remote controller.

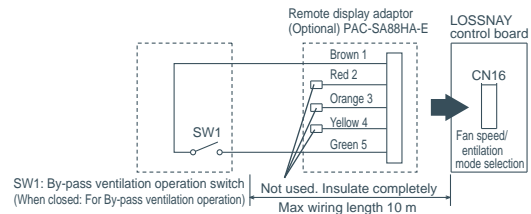

### Automatic ventilation setting

The automatic damper mode automatically provides the correct ventilation for the conditions in the room. The following shows the effect "By-pass" ventilation will have under various conditions.

#### 1. Reduces cooling load

If the air outside is cooler than the air inside the building during the cooling season (such as early morning or at night), "By-pass" ventilation will draw in the cooler outside air and reduce the cooling load on the system.

#### 2. Night purge

"By-pass" ventilation can be used to release hot air from inside the building that has accumulated in buildings a business district during the hot summer season.

#### 3. Office equipment room cooling

During cold season, fresh air can be drawn in and used as is to cool rooms where the temperature has risen due to the use of office equipment.

\* When the outdoor air temperature drops lower than 8°C it changes to the heat exchange ventilation. (Display of the remote controller does not change.)

\* In the case of "By-pass" ventilation, the supply air temperature slightly rises more than the outside air temperature because of the heat effect around the ducts or the unit motors.

## Remote Controller PZ-60DR-E

In addition to boosting the energy conservation performance of the main unit, the remote controller features a variety of functions which also pursue additional energy conservation.

The appearance of the remote controller conforms to Mitsubishi air conditioner interface design standards.

Functions that were set using Dip-Switch on the LOSSNAY main unit can now be configured as needed using the new remote controller.

This eliminates the need to crawl under the eaves to change operation settings.

Also, a newly adopted dot matrix display provides much more information, making it easy to check maintenance indications, operation status display, and explanations required when configuring settings.

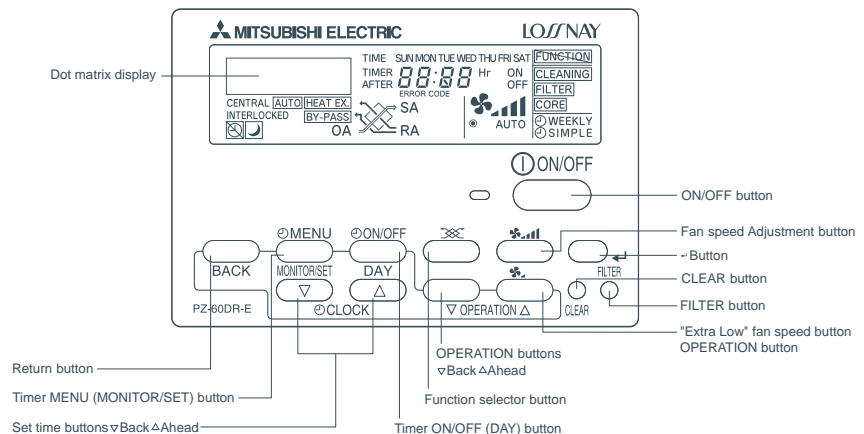





LGH-15-100RX5-E

## Model line up

### ■ Specification

#### LGH-15RX5-E

Model		LGH-15RX5-E								
Frequency / Power source		50Hz / Single phase 220-240V								
Ventilation mode		LOSSNAY ventilation				By-pass ventilation				
Fan speed		Extra High	High	Low	Extra Low	Extra High	High	Low	Extra Low	
Current (A)		0.44-0.46	0.37-0.38	0.25-0.25	0.14-0.15	0.45-0.46	0.37-0.38	0.25-0.26	0.14-0.15	
Power consumption (W)		96-110	80-90	53-59	30-35	97-110	81-91	54-61	30-35	
Air volume		(m <sup>3</sup> /h)	150	150	110	70	150	150	110	70
		(L/s)	42	42	31	19	42	42	31	19
External static pressure		(mmHzO)	10.2-10.7	6.6-7.1	3.6-4.1	1.4	10.2-10.7	6.6-7.1	3.6-4.1	1.4
		(Pa)	100-105	65-70	35-40	14	100-105	65-70	35-40	14
Temperature exchange efficiency (%)		82.0	82.0	84.0	85.5	—	—	—	—	
Enthalpy exchange efficiency (%)		Heating	75.0	75.0	77.5	81.0	—	—	—	—
		Cooling	73.0	73.0	76.5	81.0	—	—	—	—
Noise (dB) (Measured at 1.5m under the center of panel in an anechoic chamber)		27.5-28	26.5-27	22-23.5	18	28.5-29	27-28	23-24	18-19	
Weight (kg)		20								
Starting current		Under 0.8 A Less								

\*The Air outlets noise (45° angle, 1.5 meters in front of the unit) is about 6 dB greater than the indicated value. (at High Fan speed)

#### LGH-25RX5-E

Model		LGH-25RX5-E								
Frequency / Power source		50Hz / Single phase 220-240V								
Ventilation mode		LOSSNAY ventilation				By-pass ventilation				
Fan speed		Extra High	High	Low	Extra Low	Extra High	High	Low	Extra Low	
Current (A)		0.52-0.55	0.47-0.48	0.26-0.27	0.17-0.18	0.53-0.55	0.47-0.48	0.26-0.27	0.17-0.18	
Power consumption (W)		113-129	102-114	56-62	36-42	115-131	103-115	56-63	36-42	
Air volume		(m <sup>3</sup> /h)	250	250	155	105	250	250	155	105
		(L/s)	69	69	43	29	69	69	43	29
External static pressure		(mmHzO)	8.2-8.7	5.1-6.1	2-2.5	0.9	8.2-8.7	5.1-6.1	2-2.5	0.9
		(Pa)	80-85	50-60	20-25	9	80-85	50-60	20-25	9
Temperature exchange efficiency (%)		79.0	79.0	81.5	83.5	—	—	—	—	
Enthalpy exchange efficiency (%)		Heating	69.5	69.5	74.0	77.5	—	—	—	—
		Cooling	68.0	68.0	72.5	76.0	—	—	—	—
Noise (dB) (Measured at 1.5m under the center of panel in an anechoic chamber)		26-27	25-26	20-21.5	18-19	26.5-27.5	25.5-26.5	20.5-22	18-19	
Weight (kg)		20								
Starting current		Under 0.9 A Less								

\*The Air outlets noise (45° angle, 1.5 meters in front of the unit) is about 10 dB greater than the indicated value. (at High Fan speed)

#### LGH-35RX5-E

Model		LGH-35RX5-E								
Frequency / Power source		50Hz / Single phase 220-240V								
Ventilation mode		LOSSNAY ventilation				By-pass ventilation				
Fan speed		Extra High	High	Low	Extra Low	Extra High	High	Low	Extra Low	
Current (A)		0.92-0.92	0.74-0.74	0.5-0.51	0.28-0.3	0.93-0.94	0.77-0.77	0.51-0.52	0.28-0.3	
Power consumption (W)		195-212	160-169	105-116	58-69	197-217	164-173	105-116	58-69	
Air volume		(m <sup>3</sup> /h)	350	350	210	115	350	350	210	115
		(L/s)	97	97	58	32	97	97	58	32
External static pressure		(mmHzO)	15.8-16.3	7.6-8.2	2.5-3.1	0.9	15.8-16.3	7.6-8.2	2.5-3.1	0.9
		(Pa)	155-160	75-80	25-30	9	155-160	75-80	25-30	9
Temperature exchange efficiency (%)		80.0	80.0	85.0	88.0	—	—	—	—	
Enthalpy exchange efficiency (%)		Heating	71.5	71.5	76.5	81.5	—	—	—	—
		Cooling	71.0	71.0	75.5	81.0	—	—	—	—
Noise (dB) (Measured at 1.5m under the center of panel in an anechoic chamber)		32-32	28.5-29.5	21.5-23	18	32.5-32.5	29.5-30.5	21.5-24	18	
Weight (kg)		29								
Starting current		Under 2.4 A Less								

\*The Air outlets noise (45° angle, 1.5 meters in front of the unit) is about 10 dB greater than the indicated value. (at High Fan speed)





**LGH-15-100RX5-E**

**LGH-50RX5-E**

Model		LGH-50RX5-E								
Frequency / Power source		50Hz / Single phase 220-240V								
Ventilation mode		LOSSNAY ventilation				By-pass ventilation				
Fan speed		Extra High	High	Low	Extra Low	Extra High	High	Low	Extra Low	
Current (A)		1.2-1.25	1.0-1.0	0.85-0.85	0.4-0.4	1.25-1.25	1.0-1.0	0.85-0.85	0.4-0.4	
Power consumption (W)		255-286	207-228	175-190	80-95	260-290	210-230	180-195	80-95	
Air volume		(m <sup>3</sup> /h)	500	500	390	180	500	500	390	180
		(L/s)	139	139	108	50	139	139	108	50
External static pressure		(mmH <sub>2</sub> O)	15.3-15.8	6.6-9.2	4.1-6.1	1.0	15.3-15.8	6.6-9.2	4.1-6.1	1.0
		(Pa)	150-155	65-90	40-60	10	150-155	65-90	40-60	10
Temperature exchange efficiency (%)		78.0	78.0	81.0	86.0	—	—	—	—	
Enthalpy exchange efficiency (%)		Heating	69.0	69.0	71.0	78.0	—	—	—	—
		Cooling	66.5	66.5	68.0	77.0	—	—	—	—
Noise (dB) (Measured at 1.5m under the center of panel in an anechoic chamber)		33-34	30.5-32	26.5-28	19	34-35	31-32.5	27-29	19	
Weight (kg)		32								
Starting current		Under 3.0 A Less								

\*The Air outlets noise (45° angle, 1.5 meters in front of the unit) is about 16 dB greater than the indicated value. (at High Fan speed)

**LGH-65RX5-E**

Model		LGH-65RX5-E								
Frequency / Power source		50Hz / Single phase 220-240V								
Ventilation mode		LOSSNAY ventilation				By-pass ventilation				
Fan speed		Extra High	High	Low	Extra Low	Extra High	High	Low	Extra Low	
Current (A)		1.7-1.8	1.5-1.5	1.2-1.2	0.6-0.6	1.7-1.8	1.5-1.5	1.2-1.2	0.6-0.6	
Power consumption (W)		350-380	308-322	248-265	120-140	350-385	310-335	250-265	120-140	
Air volume		(m <sup>3</sup> /h)	650	650	520	265	650	650	520	265
		(L/s)	181	181	144	74	181	181	144	74
External static pressure		(mmH <sub>2</sub> O)	11.2-12.2	6.1-8.2	4.1-5.1	0.8	11.2-12.2	6.1-8.2	4.1-5.1	0.8
		(Pa)	110-120	60-80	40-50	8	110-120	60-80	40-50	8
Temperature exchange efficiency (%)		77.0	77.0	80.0	86.0	—	—	—	—	
Enthalpy exchange efficiency (%)		Heating	68.5	68.5	70.5	78.0	—	—	—	—
		Cooling	66.0	66.0	68.5	77.0	—	—	—	—
Noise (dB) (Measured at 1.5m under the center of panel in an anechoic chamber)		34-34.5	32-33	28.5-31.5	22	34.5-35	32.5-33.5	28.5-30.5	22-22.5	
Weight (kg)		40								
Starting current		Under 4.4 A Less								

\*The Air outlets noise (45° angle, 1.5 meters in front of the unit) is about 10 dB greater than the indicated value. (at High Fan speed)

**LGH-80RX5-E**

Model		LGH-80RX5-E								
Frequency / Power source		50Hz / Single phase 220-240V								
Ventilation mode		LOSSNAY ventilation				By-pass ventilation				
Fan speed		Extra High	High	Low	Extra Low	Extra High	High	Low	Extra Low	
Current (A)		1.75-1.75	1.6-1.6	1.45-1.45	0.60-0.65	1.75-1.75	1.6-1.6	1.45-1.45	0.60-0.65	
Power consumption (W)		380-415	345-370	315-340	125-145	380-415	345-370	315-340	120-145	
Air volume		(m <sup>3</sup> /h)	800	800	700	355	800	800	700	355
		(L/s)	222	222	194	99	222	222	194	99
External static pressure		(mmH <sub>2</sub> O)	14.8-15.3	10.7-12.2	8.2-9.7	2	14.8-15.3	10.7-12.2	8.2-9.7	2
		(Pa)	145-150	105-120	80-95	20	145-150	105-120	80-95	20
Temperature exchange efficiency (%)		79.0	79.0	80.5	87.5	—	—	—	—	
Enthalpy exchange efficiency (%)		Heating	71.0	71.0	72.5	79.5	—	—	—	—
		Cooling	70.0	70.0	71.5	79.5	—	—	—	—
Noise (dB) (Measured at 1.5m under the center of panel in an anechoic chamber)		33.5-34.5	32-33	30-31	22	34.5-35.5	33-34	31-32	22	
Weight (kg)		53								
Starting current		Under 3.8 A Less								

\*The Air outlets noise (45° angle, 1.5 meters in front of the unit) is about 16 dB greater than the indicated value. (at High Fan speed)



**LGH-15~100RX5-E**



**LGH-150/200RX5-E**

**LGH-100RX5-E**

Model		LGH-100RX5-E							
Frequency / Power source		50Hz / Single phase 220-240V							
Ventilation mode		LOSSNAY ventilation				By-pass ventilation			
Fan speed		Extra High	High	Low	Extra Low	Extra High	High	Low	Extra Low
Current (A)		2.3-2.4	2.1-2.1	1.7-1.7	0.9-0.9	2.3-2.4	2.1-2.1	1.7-1.7	0.9-0.9
Power consumption (W)		500-535	445-475	350-380	175-200	510-550	460-485	365-395	175-200
Air volume	(m <sup>3</sup> /h)	1000	1000	755	415	1000	1000	755	415
	(L/s)	278	278	210	115	278	278	210	115
External static pressure	(mmH <sub>2</sub> O)	16.3-17.3	10.2-11.2	5.6-6.1	1.8	16.3-17.3	10.2-11.2	5.6-6.1	1.8
	(Pa)	160-170	100-110	55-60	18	160-170	100-110	55-60	18
Temperature exchange efficiency (%)		80.0	80.0	83.0	87.0	—	—	—	—
Enthalpy exchange efficiency (%)	Heating	72.5	72.5	74.0	80.0	—	—	—	—
	Cooling	71.0	71.0	73.0	79.0	—	—	—	—
Noise (dB) (Measured at 1.5m under the center of panel in an anechoic chamber)		36-37	34-35	31-32.5	21-22	37-38	35-36	32-33	21-22
Weight (kg)		59							
Starting current		Under 4.6 A Less							

\*The Air outlets noise (45° angle, 1.5 meters in front of the unit) is about 17 dB greater than the indicated value. (at High Fan speed)

**LGH-150RX5-E**

Model		LGH-150RX5-E					
Frequency / Power source		50Hz / Single phase 220-240V					
Ventilation mode		LOSSNAY ventilation			By-pass ventilation		
Fan speed		Extra High	High	Low	Extra High	High	Low
Current (A)		3.5-3.5	3.2-3.2	2.9-2.9	3.5-3.5	3.2-3.2	2.9-2.9
Power consumption (W)		760-830	690-740	630-680	765-835	695-745	635-685
Air volume	(m <sup>3</sup> /h)	1500	1500	1300	1500	1500	1300
	(L/s)	417	417	361	417	417	361
External static pressure	(mmH <sub>2</sub> O)	16.3-17.8	13.3-13.8	9.7-10.2	16.3-17.8	13.3-13.8	9.7-10.2
	(Pa)	160-175	130-135	95-100	160-175	130-135	95-100
Temperature exchange efficiency (%)		80.0	80.0	81.0	—	—	—
Enthalpy exchange efficiency (%)	Heating	72.0	72.0	72.5	—	—	—
	Cooling	70.5	70.5	71.5	—	—	—
Noise (dB) (Measured at 1.5m under the center of panel in an anechoic chamber)		38-39	36-37.5	33.5-35	39-40.5	37.5-39	35.5-37
Weight (kg)		105					
Starting current		Under 7.3 A Less					

\*The Air outlets noise (45° angle, 1.5 meters in front of the unit) is about 19 dB greater than the indicated value. (at High Fan speed)

**LGH-200RX5-E**

Model		LGH-200RX5-E					
Frequency / Power source		50Hz / Single phase 220-240V					
Ventilation mode		LOSSNAY ventilation			By-pass ventilation		
Fan speed		Extra High	High	Low	Extra High	High	Low
Current (A)		4.8-4.8	4.2-4.2	3.4-3.4	4.8-4.8	4.2-4.2	3.4-3.4
Power consumption (W)		1035-1100	910-980	715-785	1040-1110	915-980	720-785
Air volume	(m <sup>3</sup> /h)	2000	2000	1580	2000	2000	1580
	(L/s)	556	556	439	556	556	439
External static pressure	(mmH <sub>2</sub> O)	16.3-16.8	10.2-10.7	6.1-6.6	16.3-16.8	10.2-10.7	6.1-6.6
	(Pa)	160-165	100-105	60-65	160-165	100-105	60-65
Temperature exchange efficiency (%)		80.0	80.0	83.0	—	—	—
Enthalpy exchange efficiency (%)	Heating	72.5	72.5	73.5	—	—	—
	Cooling	71.0	71.0	72.0	—	—	—
Noise (dB) (Measured at 1.5m under the center of panel in an anechoic chamber)		39.5-40	37-38	32.5-34	40.5-41	38-39	33.5-35
Weight (kg)		118					
Starting current		Under 11.9A Less					

\*The Air outlets noise (45° angle, 1.5 meters in front of the unit) is about 20 dB greater than the indicated value. (at High Fan speed)

# Control

## ■ The Remote Controller PZ-60DR-E enable simple control setting

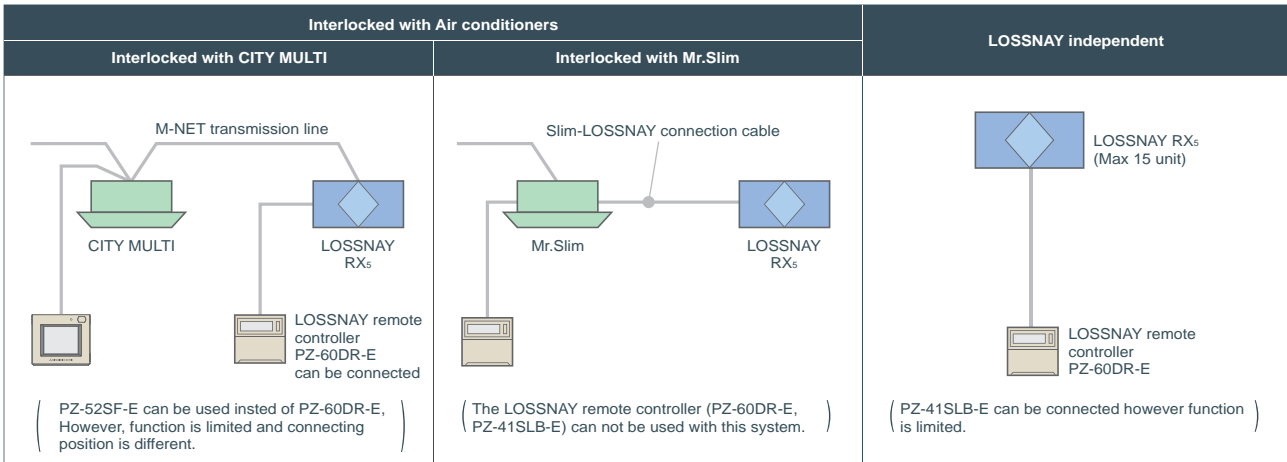

## ■ Centralized Controller System

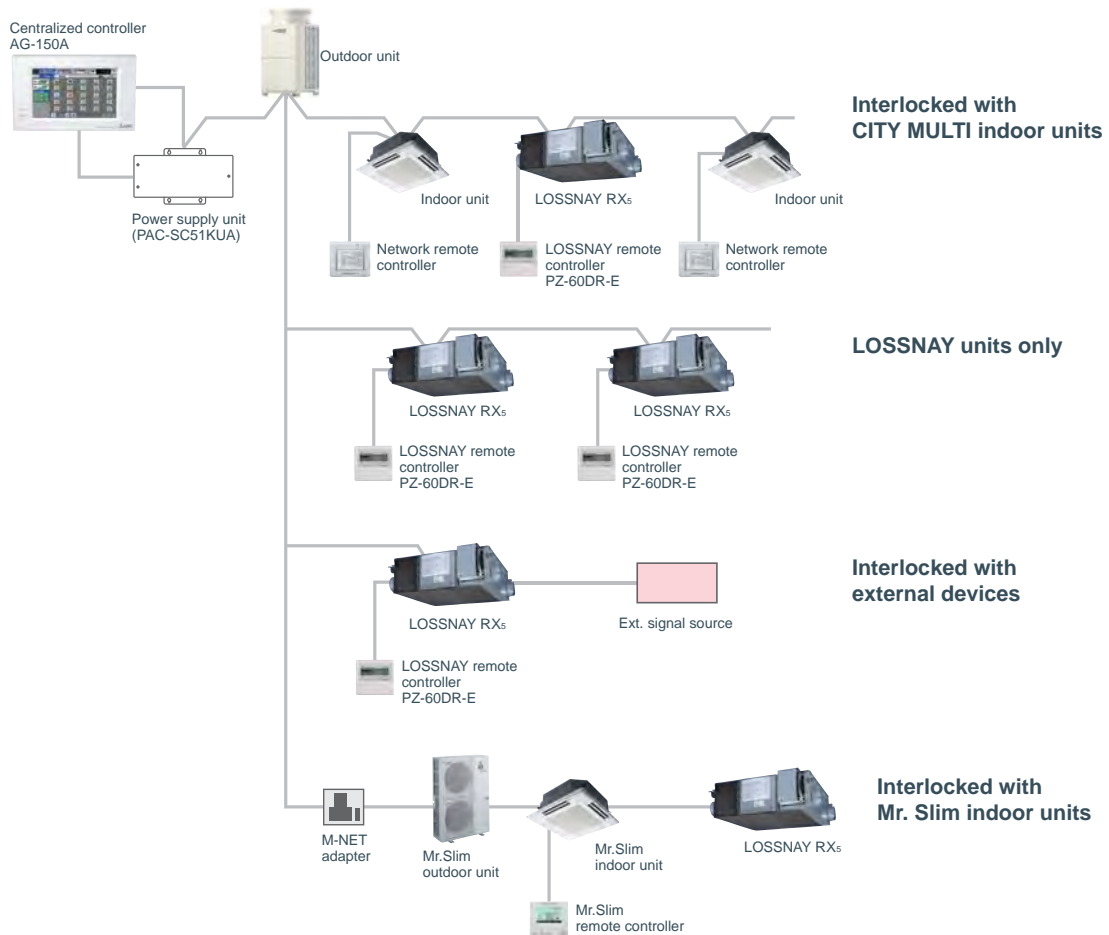

Indoor Unit

# VL-100U-E



## Heat Recovery Ventilators for Residential Use

Time Spent in Comfort with a Breath of Fresh Air

**Energy Efficient**  
Reduced heat loss contributes to lower air conditioning costs.

**Quiet Operation**  
Super sound insulation and quiet operation.

**Fresh Air**  
Simultaneous air supply/exhaust function ensures that air stays fresh with efficient ventilation.

**Simple Installation**  
Easy Installation through boring of 2 installation holes.

## Total-Heat-Exchange Concept

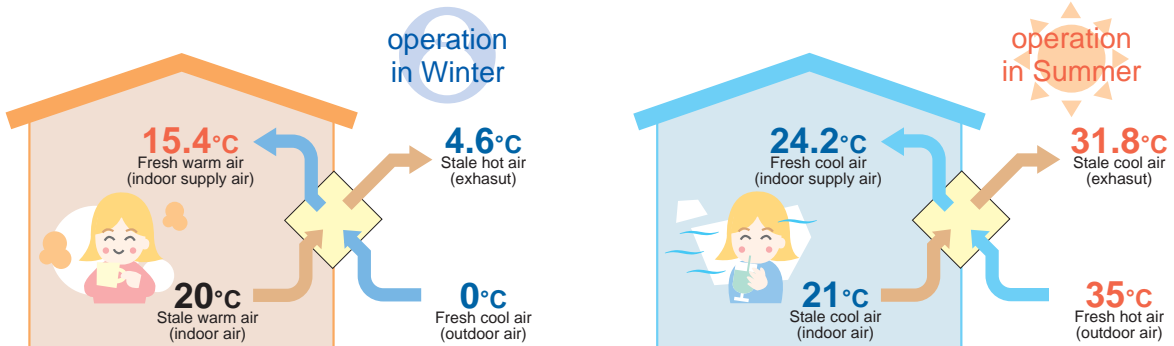

### Heat-exchange calculating equation

$$\text{Indoor supply-air temperature (}^\circ\text{C)} = \text{Outdoor temperature (}^\circ\text{C)} + \left\{ \text{Indoor temperature (}^\circ\text{C)} - \text{Outdoor temperature (}^\circ\text{C)} \right\} \times \text{temp exchange efficiency (\%)} \\ \text{Calculation example : } 15.4^\circ\text{C} = 0^\circ\text{C} + (20^\circ\text{C} - 0^\circ\text{C}) \times 77\% \quad (\text{Low notch})$$

### Heat-exchange calculating equation

$$\text{Indoor supply-air temperature (}^\circ\text{C)} = \text{Outdoor temperature (}^\circ\text{C)} - \left\{ \text{Outdoor temperature (}^\circ\text{C)} - \text{Indoor temperature (}^\circ\text{C)} \right\} \times \text{temp exchange efficiency (\%)} \\ \text{Calculation example : } 24.2^\circ\text{C} = 35^\circ\text{C} - (35^\circ\text{C} - 21^\circ\text{C}) \times 77\% \quad (\text{Low notch})$$

## Specification

- Simple installation through boring of 2 installation holes.
- Low-noise(Less than 30dB at low notch).
- 1-motor 2-fan system. •Air-volume:low/high 2-notch.
- Air-supply/exhaust pipes and plastic weather cover are supplied as accessories.
- Equipped with an outdoor-air shutter. •Pull-string switch

Supply Voltage (V)	Power line frequency (Hz)	Notch	Air volume (m <sup>3</sup> /h)	Power Consumption (W)	Temp.exchange efficiency (%)	Noise (dB)	Weight (kg)
220-240	50	HI	105	26	70	39	6.5
		LO	65	23	77	29.5	
220	60	HI	90	26	73	37	
		LO	50	21	80	26	

## Optional parts

### Extension Pipe P-100P

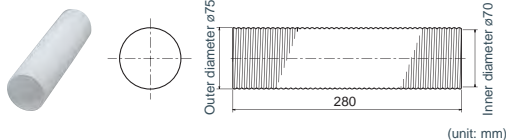

- Total length when connected to the pipe extension coupling is 300mm.

### Extension Pipe Coupling P-100PJ

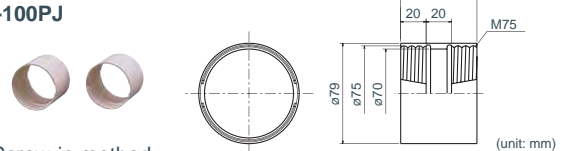

- Screw-in method

Indoor Unit



# OA Processing Units

## RDH3 Series



### Ideal Indoor-Air Quality — For Your Comfort and Health

The OA (outdoor-air) Processing Unit creates an optimum indoor-air environment at an unparalleled rate of cost efficiency. Forced air ventilating and humidifying functions unique to this system keep indoor-air fresh and free of contaminants preventing “sick building syndrome” and the spread of airborne viruses such as the flu. Another feature of the OA Processing Unit is the “Lossnay core,” a heat-exchange unit that functions to transfer heat efficiently, cutting ventilation load by as much as 70%. This special combination of functionality and performance designed to ensure users ample comfort and year-round health which cannot be found anywhere else on the market.

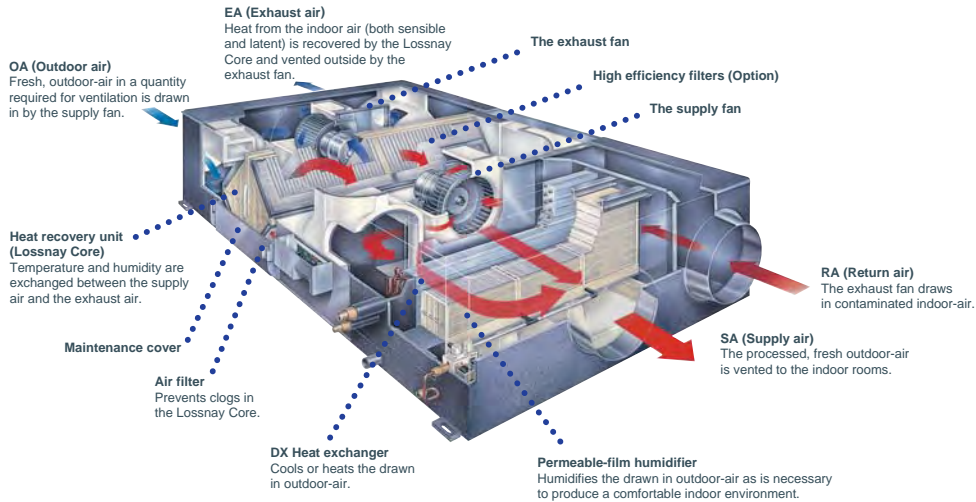

### New Permeable Film Humidifier (RDH3 model)

#### Comfortable Level of Humidity for Exceptionable Air Quality

The OA Processing Unit is equipped with a new permeable film humidifier developed and patented by Mitsubishi Electric. Steam transmission efficiency has been improved remarkably by lowering the resistance of the material. The use of a 3-layer film that allows only the transfer of steam prevents the production of white powder, so there is no need for the use of a water purifier.

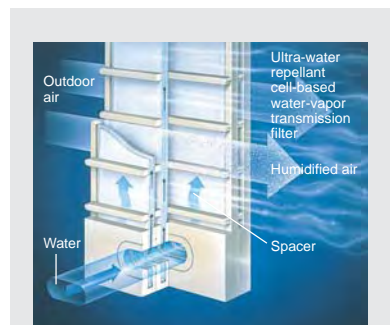

#### Highly Efficient Humidification

Improvements in the system of airflow patterns and water injection techniques have resulted in a substantial increase in humidifying volume.

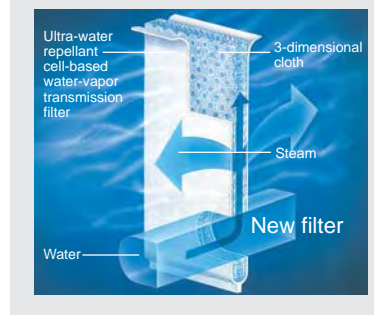

# RD3 Series

## A Total Air Conditioning Package Manifesting Remarkable Power

### Lossnay Ventilation and Air Conditioning

1. When the load is light ⇒ Main air conditioning
2. When the load is heavy ⇒ Supplemental air conditioning

The OA (outdoor-air) Processing Unit creates an optimum environment while providing substantial energy efficiency. The OA Processing Unit comprises forced air ventilation, heat recovery, heating and cooling, and air purification. This total air conditioning system keeps indoor air fresh and comfortable all year round, and keeps it free of contaminants preventing ailments such as sick building syndrome. Inside the OA Processing Unit is the Lossnay Core, a heat-exchange unit that transfers heat efficiently, cutting ventilation load by as much as 70%. A remarkable product found nowhere else, this special combination of functionality and performance contained within a single unit ensures users ample comfort, good health, and energy savings.

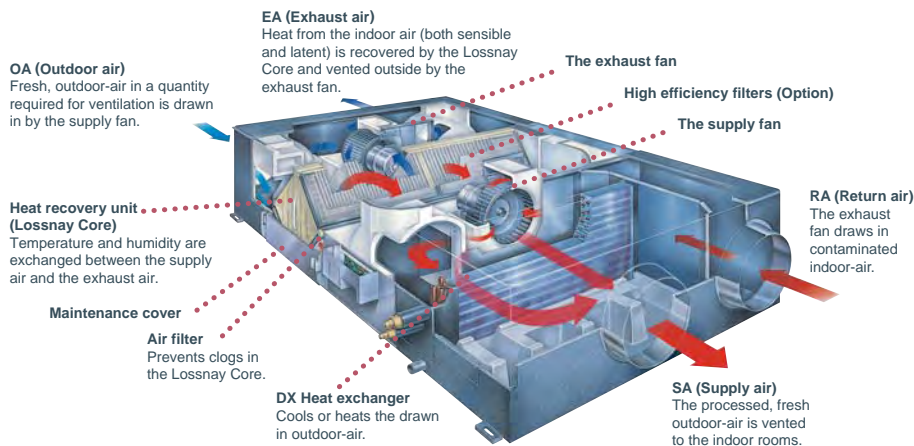

## The Air Conditioning Function

### Two Units in One

Along with Lossnay ventilation, the OA Processing Unit is really two units in one, functioning as the main air conditioner when the load is light and adding supplemental air conditioning when the load is heavy. Also, with ventilation and air conditioning integrated, space is saved and installation expense kept to a minimum. What's more, the air temperature in any room can be perfectly adjusted to the desired

temperature of the occupants via the OA Processing Unit, which can be used as the indoor unit of the CITY MULTI air conditioning system. The heat recovery function maximizes efficiency and saves energy, benefiting the environment and helping companies cut costs. It also reduces the refrigerant load and lowers the amount of horsepower required by the outdoor unit.

Temperature simulation (Example : GUF-50RD<sub>3</sub>)

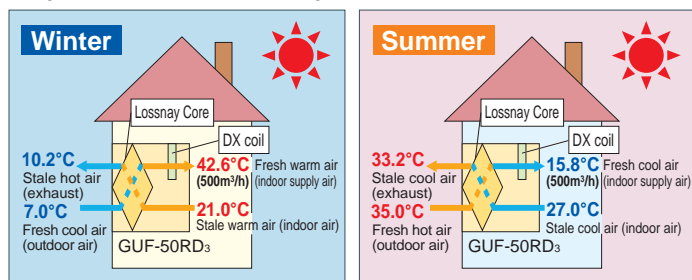

## Specification

Model			GUF-50RDH <sub>3</sub> *3	GUF-100RDH <sub>3</sub> *3	GUF-50RD <sub>3</sub>	GUF-100RD <sub>3</sub>	
Power source			1-phase 220-240V 50Hz, 1-phase 220V 60Hz				
Cooling capacity	*1	kW	5.46 <1.83>	11.17 <3.85>	5.46 <1.83>	11.17 <3.85>	
	*1	kcal / h	4,700 <1,600>	9,600 <3,300>	4,700 <1,600>	9,600 <3,300>	
	*1	BTU / h	18,600 <6,200>	38,100 <13,100>	18,600 <6,200>	38,100 <13,100>	
Power input		kW	235-265	480-505	235-265	480-505	
Current input		A	1.15	2.20	1.15	2.20	
Heating capacity	*2	kW	6.18 <2.01>	12.50 <4.20>	6.18 <2.01>	12.50 <4.20>	
	*2	kcal / h	5,300 <1,700>	10,800 <3,600>	5,300 <1,700>	10,800 <3,600>	
	*2	BTU / h	21,100 <6,900>	42,700 <14,300>	21,100 <6,900>	42,700 <14,300>	
Power input		kW	235-265	480-505	235-265	480-505	
Current input		A	1.15	2.20	1.15	2.20	
Capacity equivalent to indoor unit			P32	P63	P32	P63	
Humidifying capacity		kg / h	2.7	5.4	-	-	
		lbs / h	6.0	12.0	-	-	
Humidifier			Permeable film humidifier			-	
External finish			Galvanized, with grey insulation sheet				
External dimension H x W x D		mm	317 x 1,016 x 1,288	398 x 1,231 x 1,580	317 x 1,016 x 1,288	398 x 1,231 x 1,580	
		in.	12-1/2 x 40 x 50-3/4	15-11/16 x 48-1/2 x 62-1/4	12-1/2 x 40 x 50-3/4	15-11/16 x 48-1/2 x 62-1/4	
Net weight		kg (lbs)	57 (126)	98 (217)	54 (120)	92 (203)	
Heat exchanger		LOSSNAY core	Partition, Cross-flow structure, Special preserved paper-plate.				
FAN		Refrigerant coil	Cross fin (Aluminum fin and copper tube)				
		Type x Quantity	SA: Centrifugal fan (Sirocco fan) x 1 EA: Centrifugal fan (Sirocco fan) x 1				
External static press.		Pa	125	135	140	140	
		mmH <sub>2</sub> O	12.7	13.8	14.3	14.3	
Motor type			Totally enclosed capacitor permanent split-phase induction motor, 4 poles, 2units				
Motor output		kW	-	-	-	-	
Driving mechanism			Direct-driven by motor				
Airflow rate (High value)		m <sup>3</sup> / h	500	1,000	500	1,000	
		L / s	139	139	139	139	
		cfm	294	589	294	589	
Sound pressure level (Low-High) (measured in anechoic room)		dB <A>	33.5-34.5	38-39	33.5-34.5	38-39	
Insulation material			Polyester sheet				
Air filter		Supplying air	Non-woven fabrics filter (Gravitational method 82%) & Optional part: High efficiency filter (Colorimetric method 65%)				
		Exhausting air	Non-woven fabrics filter (Gravitational method 82%)				
Protection device			Fuse				
Refrigerant control device			LEV				
Diameter of refrigerant pipe		Liquid	mm (in.)	ø6.35 (ø1/4) Flare	ø9.52 (ø3/8) Flare	ø6.35 (ø1/4) Flare	ø9.52 (ø3/8) Flare
		Gas	mm (in.)	ø12.7 (ø1/2) Flare	ø15.88 (ø5/8) Flare	ø12.7 (ø1/2) Flare	ø15.88 (ø5/8) Flare
Diameter of drain pipe		mm (in.)	VP25				

### Notes:

- \*1 Cooling : Indoor 27°CDB/19°CWB, Outdoor 35°CDB/24°CWB
- \*2 Heating : Indoor 20°CDB/13.8°CWB, Outdoor 7°CDB/16°CWB
- \*3 Available for limited countries. Please contact your local distributor for further information.





# Remote Controller

- **Individual Remote Controller**
- **Centralized Remote Controller**



# The Importance of Control

The need for control is paramount in order to optimise the performance of any air conditioning system and minimise its running costs. Mitsubishi Electric offers a wide range of control options designed to meet such needs.

Operating an air conditioning system without the right control can prove costly. It's therefore important to ensure that every system is correctly specified to the degree of control it requires. Mitsubishi Electric have a wide range of controls available and individual control systems can be specifically designed to match.

Good controls will benefit any application, large or small. Air conditioning products need to react to a variety of factors: different room sizes, usage and staff levels; changes in the climate; electronic equipment and lighting ...the list goes on. So whatever the application, optimum control of air conditioning systems is essential and will result in a constant, comfortable environment, which in turn is both energy and cost efficient.

## A Degree of Difference

When an air conditioning system is not properly controlled, it will not run as efficiently as it should. For every degree that the system deviates from the required temperature, energy consumption can rise by up to 5%. Specify one of the many control options from Mitsubishi Electric to ensure air conditioning works as intended, whilst giving the optimum amount of control.

## The Simpler, The Better

With the array of comprehensive control systems available from Mitsubishi Electric, it becomes simple to design and install air conditioning systems. From a simple hand-held controller to a AE-200E system - you are in control.



# System Controller

MITSUBISHI ELECTRIC's Air-conditioner Network System (MELANS) leads air conditioner management to a PC browser and Network era.

M-NET

## MELANS

Use of our MELANS products enhances EFFICIENCY and QUALITY of air-conditioning, contributing to ENERGY SAVING and reduction in running cost. We offer a wide variety of MELANS products to meet all requirements - from the smallest and simplest to the largest and most complex.

We have individual remote controllers, various centralised controllers, and centralised integrated software, as well as BMS interface hardware and software etc. Above all, with AE-200E/AG-150A, PC browser and long distance remote control (monitoring and operating) via communication Network is possible and easy.

### Individual Remote Controller

All of the local remote controllers feature liquid crystal and LED displays and easy to operate.

#### Remote Controller



PAR-31MAAE



PAR-U02MEDA

#### Simple Remote Controller



PAC-YT52CRA

#### Wireless Remote Controller



PAR-FL32MA



PAR-FA32MA



PAR-SA9FA-E



PAR-SL94B-E

### Centralized Remote Controller

#### Advanced Touch Controller



AT-50B



PAC-YT40ANRA

#### NEW AE-200E/AE-50E



#### AG-150A



PAC-YG50ECA

### CITY MULTI

#### OUTDOOR UNIT

● Y : PUHY

● R2 : PURY

#### INDOOR UNIT

● PEFY ● PCFY

● PMFY ● PKFY

● PLFY ● PFFY

#### AHC ADAPTER



PAC-IF01AHC-J

#### PI Controller



PAC-YG60MCA

#### DIDO Controller



PAC-YG66DCA

#### AI Controller



PAC-YG63MCA

\*1. Advanced HVAC CONTROLLER

#### Interface



BAC-HD150



#### Interface



LMAP04-E

BACnet<sup>®</sup> transmission line (Ethernet)

LONWORKS<sup>®</sup> transmission line

MITSUBISHI ELECTRIC's CITY MULTI can be easily connected to the building management system through BACnet<sup>®</sup>.



Ethernet

### Air-Conditioning Control System

This is a specialized air conditioning management system, in which up to 2000 indoor units can be centrally controlled.

#### Integrated centralized control software TG-2000A



Integrated centralized control software TG-2000A

\*Some controllers cannot be used in combination with certain models of devices.



# Integrated Communications Control with Mitsubishi Electric's Unique Transmission Network (M-NET)

Model	Local remote controller *10				System controller									
	PAR-31MAAE	PAR-U02MEDA	PAC-YT52CRA	PAR-FL32MA	PAC-YT40ANRA	AT-50B	AE-200E / AE-50E	AE-200E + AE-50E	AG-150A	AG-150A + PAC-YG50ECA	TG-2000A			
Controllable Groups / Indoors (Group / Indoor)	1 / 16	1 / 16	1 / 16	1 / 16	16 / 50	50 / 50	50 / 50	200 / 200	50 / 50	150 / 150	2000 / 2000			
■Operating														
ON / OFF	○	○	○	○	◎	◎	◎	◎	◎	◎	◎	◎	◎	
Mode (cool / heat / dry / fan)	○	○	○	○	N	◎	◎	◎	◎	◎	◎	◎	◎	
Temperature-set	○	○	○	○	N	◎	◎	◎	◎	◎	◎	◎	◎	
Dual set point **11	○	○	○	○	N	◎ <sup>12</sup>	◎	◎	◎	N	N	N	N	
Local Permit / Prohibit	N	N	N	N	N	◎	◎	◎	◎	◎	◎	◎	◎	
Fan speed	○	○	○	○	N	◎	◎	◎	◎	◎	◎	◎	◎	
Air-flow direction	○	○	○	○	N	◎	◎	◎	◎	◎	◎	◎	◎	
■Status monitoring														
ON / OFF	○	○	○	○	◎	◎	◎	◎	◎	◎	◎	◎	◎	
Mode (cool / heat / dry / fan)	○	○	○	○	N	◎	◎	◎	◎	◎	◎	◎	◎	
Temperature-set	○	○	○	○	N	◎	◎	◎	◎	◎	◎	◎	◎	
Local Permit / Prohibit	○	○	○	○	○	◎	◎	◎	◎	◎	◎	◎	◎	
Fan speed	○	○	○	○	N	◎	◎	◎	◎	◎	◎	◎	◎	
Air-flow direction	○	○	○	○	N	◎	◎	◎	◎	◎	◎	◎	◎	
Indoor temperature	○	○	○	N	N	◎	◎	◎	◎	◎	◎	◎	◎	
Filter sign	○	○	N	N	N	◎	◎	◎	◎	◎	◎	◎	◎	
Error flashing	○	○	○	○	○	◎	◎	◎	◎	◎	◎	◎	◎	
Error code	○	○	○	N	○	○	○	○	○	○	○	○	○	
Operation hour	N	N	N	N	N	N	N	N	N	N	N	N	●	
■Scheduling														
One-day	○	○	N	N	N	○	◎	◎	◎	◎	◎	◎	◎	
Times of ON / OFF per day	1	1	N	1	N	16	24	24	24	24	24	24	24	
Weekly	○	○	N	N	N	○	◎	◎	◎	◎	◎	◎	◎	
Times of ON / OFF per week	8 x 7	8 x 7	N	N	N	16 x 7	24 x 7	24 x 7	24 x 7	24 x 7	24 x 7	24 x 7	24 x 7	
Annual	N	N	N	N	N	N	◎	◎	◎	◎	◎	◎	◎	
Optimized start-up	N	N	N	N	N	N	○	○	○	○	○	○	○	
Auto-off timer	○	○	N	N	N	N	N	N	N	N	N	N	N	
Min. timer setting unit (minute)	5	5	N	10	N	5	1	1	1	1	1	1	1	
■Recording														
Error record	○	N	N	N	N	○	○	○	○	○	○	○	○	
Daily / monthly report	N	N	N	N	N	N	N	N	N	N	N	N	◎	
Electricity charge	N	N	N	N	N	N	N	N	N	N	N	N	●	
Energy management data	N	N	N	N	N	N	N	●	N	●	N	N	N	
■Other														
Temp-set limitation by Local R / C	○	○	○	N	N	N	N	N	N	N	N	N	N	
Temp-set limitation by System controller *4	○ <sup>16</sup>	○	○ <sup>16</sup>	N	N	○ <sup>16</sup>	N	○ <sup>16</sup>	N	○ <sup>16</sup>	N	○ <sup>16</sup>	◎ <sup>16</sup>	
Operation-lock	○	○	○	N	N	◎	N	N	N	N	N	N	N	
Night setback	○	○	N	N	N	◎	○	○ <sup>2</sup>	○	○ <sup>2</sup>	○	○ <sup>2</sup>	○	
Sliding temperature control	N	N	N	N	N	N	○	○ <sup>2</sup>	○	○ <sup>2</sup>	○	○ <sup>2</sup>	○	
■Management (Group / Interlocked)														
Ventilation interlock	N / ○	N / ○	N / ○	N	○	○	○	○ <sup>2</sup>	○	○ <sup>2</sup>	○	○ <sup>2</sup>	○ / ○	
Group setting	○ <sup>11</sup>	○	○ <sup>11</sup>	N	○	○	○	○ <sup>2</sup>	○	○ <sup>2</sup>	○	○ <sup>2</sup>	○	
Block setting	N	N	N	N	N	N	○	○ <sup>2</sup>	○	○ <sup>2</sup>	○	○ <sup>2</sup>	○	
Revision of electricity charge	N	N	N	N	N	N	N	N	N	N	N	N	□ ●	
■Operating on LOSSNAY interlocked (Group / Interlocked)														
ON / OFF	N / ○	N / ○	N / ○	N / ○ <sup>8</sup>	◎ / ◎ <sup>3</sup>	◎ / ◎	◎ / ◎	◎ / ◎	◎ / ◎	◎ / ◎	◎ / ◎	◎ / ◎	◎ / ◎	
Fan speed	N / ○	N / ○	N	N	N	◎ / ◎	◎ / ◎	◎ / ◎	◎ / ◎	◎ / ◎	◎ / ◎	◎ / ◎	◎ / ◎	
Ventilation mode	N / N	N	N	N	N	◎ / N	◎ / N	◎ / N	◎ / N	◎ / N	◎ / N	◎ / N	○ / N	
■Status monitoring on LOSSNAY interlocked (Group / Interlocked)														
ON / OFF	N / ○	N / ○	N / ○	N	N	○ / ○	◎ / ◎	◎ / ◎	◎ / ◎	◎ / ◎	◎ / ◎	◎ / ◎	◎ / ◎	
Fan speed	N / ○	N / ○	N	N	N	○ / ○	○ / ○	○ / ○	○ / ○	○ / ○	○ / ○	○ / ○	○ / ○	
Ventilation mode	N	N	N	N	N	○ / N	○ / N	○ / N	○ / N	○ / N	○ / N	○ / N	○ / N	

◎ : Each group / Batched ; ○ : Each group ; □ : Block (for CITY MULTI Indoor unit, not for all Mr.SLIM) ; ● : AE-200E/AE-50E/AG-150A license registration possible.  
 ● : License registration for the optional functions required N : Not Available (Not Used.) △ : Batched only ; ▲ : Batched handling (for maintenance) ■ : Block

\*1. Group setting via wiring between Indoor units with cross-over cable;  
 \*2. Installation possible at Initial setting web browser;  
 \*3. Inter-lock is set at Local remote controller.  
 \*4. AE-200E/AE-50E/AG-150A/EB-50GU-J/GB-50ADA-J license registration to AE-200E/AE-50E/AG-150A/EB-50GU-J/GB-50ADA-J is required to monitor and operate the units by browser and TG-2000A.  
 \*5. AG-150A connected with PAC-YG50ECA is compatible with TG-2000A Ver.6.10\* or later. GB-50ADA-J is compatible with TG-2000A Ver. 6.30\* or later. EB-50GU-J is compatible with TG-2000A Ver. 6.40A or later. AE-200E/AE-50E is compatible with TG-2000A Ver. 6.50\* or later.  
 \*6. This function can be set only on the ME remote controller. This function cannot be used with the MA/Simple MA remote controller.  
 (But, the validity of this function with the MA/Simple MA remote controller depends on the indoor unit model, and there are possibilities that this function can be used with them.)  
 \*7. This function is available only when applying together with TG-2000A, AE-200E/AE-50E/AG-150A, GB-50ADA-J, and EB-50GU-J.  
 \*8. Inter-lock is set from system controllers (Except PAC-YT40ANRA) or local remote controllers.  
 \*9. The maximum number of controllable units decreases depending on the indoor unit model.  
 \*10. For indoor use only.  
 \*11. This function is supported only when all the indoor units, remote controllers, and system controllers that are connected to a given group features the function.  
 \*12. For the availability of the function, please contact your local distributor.

LOSSNAY remote controller PZ-52SF	
■Controllable LOSSNAY Groups	1
■Controllable LOSSNAY unit	16
■Operating	
ON/OFF	○
Mode (automatic ventilation/vent-heat interchange/normal ventilation)	○
Local Permit-Prohibit	N
Fan speed	○
Air flow direction	N
■Scheduling	N
■Recording	N

■Management	○
Group setting	○
Block setting	N
■Status monitoring	
ON/OFF	○
Mode (automatic ventilation/vent-heat interchange/normal ventilation)	○
Local Permit-Prohibit	○
Fan speed	○
Air flow direction	N
Filter sign	○
Error flashing	○
Error code	○

**Air conditioner control system interface**  
**LMAP04-E : LonWorks® Interface**  
 Controls up to 50 Groups/ 50 units, for details, refer to its description.  
**BAC-HD150: BACnet® Interface**  
 Controls up to 50 Groups/ 50 units, up to 150 Groups/ 150 units with three expansion controllers for details, refer to its description.

○ : Each group, N: Not Available

## Remote Controller

# Individual Remote Controller

## Wired MA remote controller PAR-31MAAE



Dimensions: 120(W) x 120(H) x 19(D) mm  
: 4-3/4(W) x 4-3/4(H) x 3/4(D) in.

### Example of system configuration

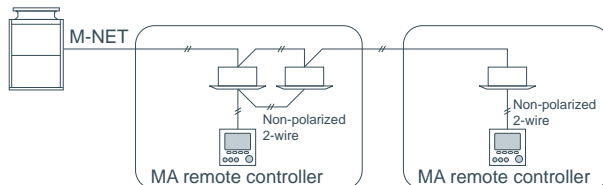

\*When a PAR-31MAAE is connected to a group, no other MA remote controllers can be connected to the same group.

### Operation pattern during Auto (dual set point) mode

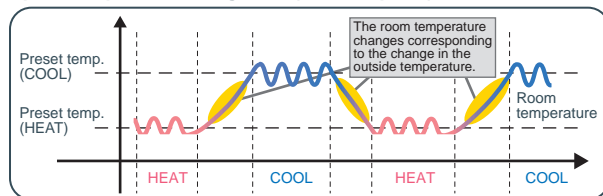

- Temperature will be displayed either in Centigrade in 0.5- or 1-degree increments, or in Fahrenheit, depending on the indoor unit model and the display mode setting on the remote controller.

### • Dual set point

When the operation mode is set to the Auto (dual set point) mode, two preset temperatures (one each for cooling and heating) can be set. Depending on the room temperature, indoor unit will automatically operate in either the Cool or Heat mode and keep the room temperature within the preset range.

\*Please contact your Mitsubishi Electric sales office for details.

### • Backlit LCD (Liquid Crystal Display)

Large, easy-to-see display

Full-dot LCD display with large characters for easy viewing

Contrast also adjustable

### • Night Setback

To prevent indoor dew or excessive temperature rise, this control starts heating operation when the control object group is stopped and the room temperature drops below the preset lower limit temperature. Also, this control starts cooling operation when the control object group is stopped and the room temperature rises above the preset upper limit temperature.

### • Language selection

Language to be displayed on the screen can be selected from eight languages: English, French, German, Spanish, Italian, Portuguese, Swedish, and Russian.

## Functions

		○: Each group	×: Not available
Item	Description	Operations	Display
ON/OFF	Switches between ON and OFF.	○	○
Operation mode switching	Switches among Cool/Dry/Fan/Auto/Heat.	○	○
Room temp. setting	The temperature can be set within the following range. Cool/Dry : 19°C - 30°C / 67°F - 87°F Heat : 17°C - 28°C / 63°F - 83°F Auto : 19°C - 28°C / 67°F - 83°F * Set temperature range varies depending on the model.	○	○
Air flow direction setting	Changes airflow direction. * Available airflow directions vary depending on the model.	○	○
Louver setting	Switches between louver ON/OFF.	○	○
Ventilation equipment control	Interlocked setting and interlocked operation setting with the CITY MULTI LOSSNAY units can be made. The Stop/Low/High settings of the ventilation equipment can be controlled.	○	○
Error information	When an error occurs, an error code and the unit address appear. Air conditioning unit model, serial number, and contact number can be set to appear when an error occurs. (The information above needs to be entered in advance.) * An error code may not appear depending on the error.	-	○
Timer	ON/OFF timer Turns ON and OFF daily at a set time. • Time can be set in 5-minute increments. • It is also possible to set the ON time only or the OFF time only. Auto-OFF timer Turns off the unit after a certain period of operation. • Operation time can be set to a value from 30 to 240 minutes in 10-minute increments.	○	○
Allows/disallows local operation	The following operation can be prohibited by making certain settings on the centralized controller: ON/OFF, operation mode setting, temperature setting, fan speed, air direction, and filter sign reset. * While an operation is prohibited, the operation icon lights up (only on the Main display in the "Full" mode).	×	○
Operation lock	The following operation can be prohibited respectively: ON/OFF, operation mode setting, temperature setting, and airflow direction setting.	○	○
Temperature range restriction	The room temperature range for each operation mode can be restricted.	○	○
Auto return	The units operate at the preset temperature after a designated period. (Time can be set to a value from 30 to 120 in 10-minute increments.) * Not valid when the temperature setting range is restricted.	○	×



## Smart ME Controller PAR-U02MEDA

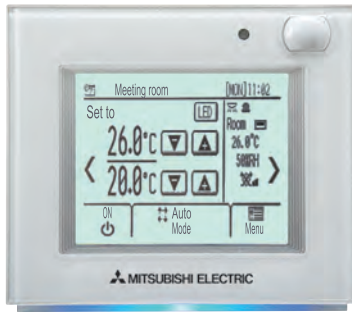

Dimensions : 140(W) x 120(H) x 25(D) mm  
: 5-9/16(W) x 4-3/4(H) x 1(D) in.



- Smart ME Controller is a remote controller designed to control Mitsubishi Electric's air conditioning units and also allows for the control of other manufacturer's products connected via Mitsubishi Electric's AHC (Advanced HVAC CONTROLLER).

- It can control up to sixteen indoor units and one AHC.

- Smart ME Controller features such basic functions as operations and monitoring of air conditioning units and schedule-control functions and is equipped with four built-in sensors (temperature, humidity, occupancy, brightness), which enable an integrated control of the system, including the humidifiers and ventilation units connected to the system via AHC, to help create a comfortable environment.

When the built-in occupancy sensor detects vacancy in a specific zone, the controller uses its internal function to reduce energy-consumption.

### Example of system configuration

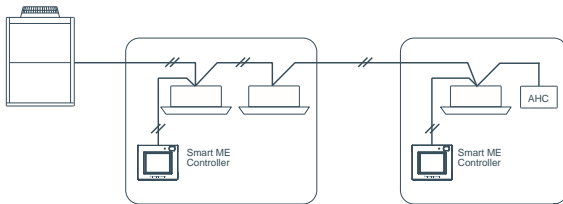

## Functions

○:Each group    ×:Not available

Item	Description	Operations	Display
ON/OFF	Switches between ON and OFF.	○	○
Operation mode switching	Switches between Cool / Drying / Fan / Heat / Auto. Operation modes vary depending on the indoor unit model. Auto mode is for CITY MULTI R2, and WR2 series only.	○	○
Temperature setting	The temperature can be set within the following range. Cool / Drying : 19°C - 35°C / 67°F - 95°F Heat : 4.5°C - 28°C / 40°F - 83°F Auto : (single set point) : 19°C - 28°C / 67°F - 83°F Auto : (dual set points) [Cool] Same as the set temp. range for Cool mode. [Heat] Same as the set temp. range for Heat mode. * The settable temperature ranges vary depending on the indoor unit model.	○	○
Fan speed setting	Changes fan speed. * Available fan speeds vary depending on the model.	○	○
Air flow direction setting	Changes airflow direction. * Available airflow directions vary depending on the model.	○	○
Allows/disallows local operation	The following operation can be prohibited by making certain settings on the centralized controller: ON/OFF, operation mode setting, temperature setting, fan speed, air direction, and filter sign reset. * While an operation is prohibited, the operation icon lights up.	×	○
Error information	When an error occurs, an error code and the unit address appear. Contact number can be set to appear when an error occurs. (The information above needs to be entered on the Service menu.)	—	○
Schedule (Weekly timer)	Weekly ON/OFF times, operation mode, and set temperatures can be set. • Time can be set in 5-minute increments. Up to 8 schedule patterns can be set per day of the week. * Not valid when the ON/OFF timer is set.	○	○
Timer	ON/OFF timer Turns ON and OFF daily at a set time. • Time can be set in 5-minute increments. • It is also possible to set the ON time only or the OFF time only. Auto-OFF timer Turns off the unit after a certain period of operation. • Operation time can be set to a value from 30 to 240 in 10-minute increments.	○	○
Energy-save control during vacancy	When vacancy is detected by the occupancy sensor, the energy-save control assist function is activated. Four control types are available for selection: ON/OFF/Set temperature/Fan speed/Thermo-off. The brightness sensor can be used in conjunction with the occupancy sensor to detect the occupancy/vacancy status more accurately.	○	○

# Individual Remote Controller

## Simple remote controller PAC-YT52CRA (MA)



Dimensions: 70(W) x 120(H) x 14.5(D) mm  
: 2-3/4(W) x 4-23/32(H) x 9/16(D) in.

### Example of system configuration

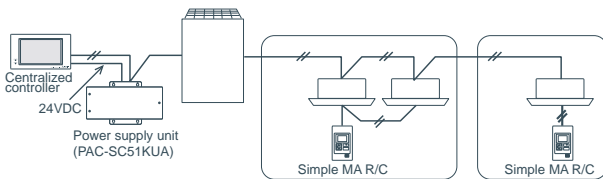

### • Dual set point

When the operation mode is set to the Auto (dual set point) mode, two preset temperatures (one each for cooling and heating) can be set. Depending on the room temperature, the indoor unit will automatically operate in either the Cool or Heat mode and keep the room temperature within the preset range.

\*Please contact your Mitsubishi Electric sales office for details.

### • Backlit LCD (Liquid Crystal Display)

Backlight for operation in dark place

### • Flat back

Install without hole on wall Slim and flat type  
Thickness is less than 14.5mm [0.6(in)]

### • Vane button (standard)

The Vane button has been added to allow the user to change airflow direction (ceiling-cassette and wall-mounted types).

Pressing the  button will switch the vane directions.



\*The settable vane direction varies depending on the indoor unit model to be connected.

\* If the unit has no vane function, the vane direction cannot be set.

In this case, the vane icon blinks when the  button is pressed.

### • The only wiring required is cross-over wiring based on two-wire signal lines.

### • Room temperature sensors are built-in.

### • Can operate all types of indoor units

\*Since this controller has limited functions, it should always be used in conjunction with standard controller or centralized controller.

### • LCD temperature setting and display in 1°C /1°F increments.

## Functions

Item	Description	□: Each unit ○: Each group ×: Not available	
		Operations	Display
ON/OFF	Changes between ON and OFF.	○	○
Operation mode switching	Select from COOL, DRYING, FAN, AUTO, and HEAT. * AUTO mode is settable only when those functions are available on the indoor unit.	○	○
Temperature setting	The temperature can be set within the following range. Cool/Drying : 19°C - 35°C/67°F - 95°F Heat : 4.5°C - 28°C/40°F - 83°F Auto (single set point) : 19°C - 28°C/67°F - 83°F Auto (dual set points) [Cool] Same as the set temp. range for Cool mode. [Heat] Same as the set temp. range for Heat mode. * Set temperature range varies depending on the model.	○	○
Fan speed setting	Changes the fan speed. * The settable fan speed varies depending on the indoor unit model to be connected.	○	○
Permit / Prohibit local operation	By setting a centralized controller, the following local operations are prohibited: ON/OFF; operation mode; preset temperature; * The CENTRAL icon appears while the local operations are prohibited.	×	○
Error	Displays the current error status with the address. * The address may not be displayed depending on the error status.	×	□
Ventilation equipment	When the CITY MULTI indoor unit is connected, interlocked setting of the CITY MULTI LOSSNAY unit is possible. When the Mr. SLIM indoor unit (A-control) is connected, interlocked operation of the microcomputer-type LOSSNAY unit is possible.	○	○
Set temperature range limit	The preset temperature range can be restricted for each operation mode (COOL/HEAT/AUTO).	○	○



# Wireless remote controller PAR-FL32MA / PAR-FA32MA / PAR-SA9FA



PAR-FL32MA

Dimensions: 58(W) x 159(H) x 19(D) mm  
: 2-5/16(W) x 6-5/16(H) x 3/4(D) in.



PAR-FA32MA

Dimensions: 70(W) x 120(H) x 22.5(D) mm  
: 2-3/4(W) x 4-3/4(H) x 7/8(D) in.

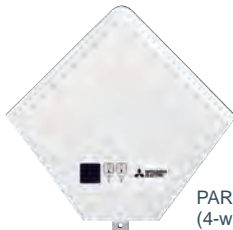

PAR-SA9FA-E  
(4-way Cassette signal receiver)

Dimensions: 256(H) x 19(D) mm



PAR-SL94B-E

(Wireless remote controller kit for ceiling suspended)

Dimensions: 182(W) x 57(H) x 31(D) mm

- **No need to configure addresses for group operation.**
- **Lit LED keeps you informed of operation - blinking even gives you the error code via the number of blinks.**
- **Can be used with the MA remote controller.**  
\*When used in group configurations, wiring between indoor units is required.  
\*Combining ME remote controller and/or LOSSNAY remote controller in a group is not possible.
- **LCD temperature setting and display in 1°C /1°F increments.**

## Example of system configuration

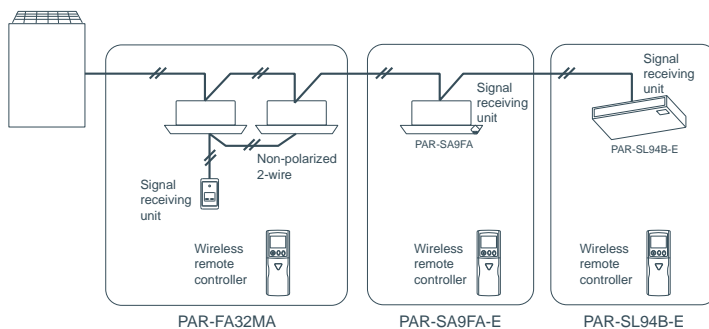

## Correspondence table

	receiver	transmitter
PMFY-P VBM PLFY-P VCM/VLMD PFFY-P VKM PEFY-P VMR-E-L/R/VMH PFFY-P VLEM/VKM/VLRM/VLRMM PEFY-P VMS1(L) PEFY-P VMA(L)	PAR-FA32MA	PAR-FL32MA
PCFY-P VKM	PAR-FA32MA PAR-SL94B-E	
PLFY-P VBM-E	PAR-SA9FA-E	
PKFY-P VBM-E PKFY-P VHM/VKM	Built-in	

## Functions

Item	Description	Operations/Display	
		Operations	Display
ON/OFF	ON and OFF operation for a single group	○	○
Temperature setting	Sets the temperature for a single group Range of temperature setting Cool/Dry : 19°C - 30°C (14°C - 30°C) / 67°F - 87°F (57°F - 87°F) Heat : 17°C - 28°C (17°C - 28°C) / 63°F - 83°F (63°F - 83°F) Auto : 19°C - 28°C (17°C - 28°C) / 67°F - 83°F (63°F - 83°F) ( ) For PEFY/PFFY by setting DipSW 7-1 to ON and limits to Ni6H fan speed only. * Set to PAR-FL32MA according to its Installation Manual 4 "Model setting".	○	○
Air flow direction setting	Air flow direction angles (4-angle, Swing) Auto Louver ON/OFF. Air flow direction settings vary depending on the model.	*	*
Timer operation	One ON/OFF setting can be set for one day.	○	○
Permit / Prohibit local operation	Individually prohibit operation of each local remote control function (ON/OFF, Change operation mode, Set temperature, Reset filter). *1 If operation is performed when the local remote controller inactivation command is received from the main system controller, a buzzer will ring and an LED will flash.	X	○ <sup>*1</sup>
Ventilation equipment	Up to 16 indoor units can be connected to an interlocked system that has one LOSSNAY. The LOSSNAY will run in interlock with the operation of indoor unit. *2 The fan rate and mode cannot be changed.	X <sup>*2</sup>	X

\*Some models will have different display for the air flow direction and fan speed. Set the air flow direction and fan speed when performing initial setting.

## Remote Controller



# Centralized Remote Controller

With our new Advanced Touch Controller AT-50B, easy and simple operation on the touch panel offers an optimal air environment for individual unit.

## Advanced Touch controller AT-50B



Dimensions: 180(W) x 120(H) x 30(D) mm  
: 7-2/16(W) x 4-12/16(H) x 1-3/16(D) in.



- Temperature will be displayed either in Centigrade in 0.5- or 1-degree increments, or in Fahrenheit, depending on the indoor unit model and the display mode setting on the remote controller.

- **Dual set point**  
When the operation mode is set to the Auto (dual set point) mode, two preset temperatures (one each for cooling and heating) can be set. Depending on the room temperature, indoor unit will automatically operate in either the Cool or Heat mode and keep the room temperature within the preset range.

\*Please contact your Mitsubishi Electric sales office for details.

### System structure

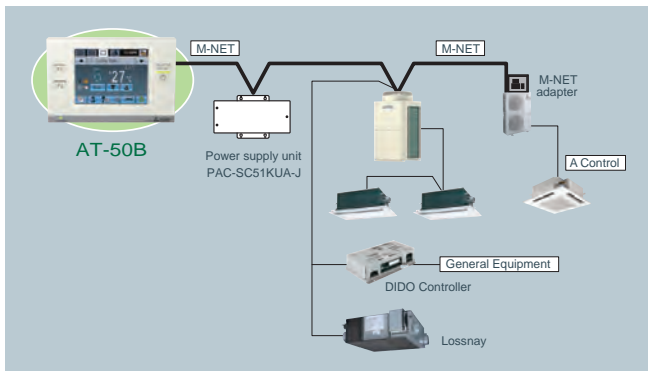

### Operation pattern during Auto (dual set point) mode

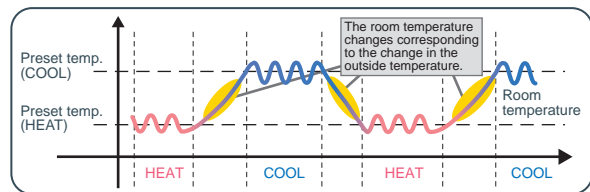

## Design

### Backlit LCD (Liquid Crystal Display) Touch Panel

5-inch color LCD touch panel enables easy and simple operation.

The backlight lights up when the panel is touched, and lights off after certain period of time.

The touch panel displays the operation status of the units in GRID, LIST or in GROUP.



**GRID (zoom-out) screen**  
Displays the operation status of all groups.



**GRID (zoom-in) screen**  
Displays the detailed operation status of each group.

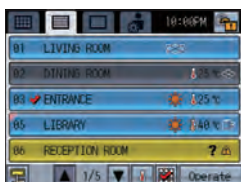

**LIST screen**  
Displays the detailed operation status of each group with group name.



**GROUP screen**  
Displays the detailed operation status of each group. Sets group operations.



## Functions

### Three in One

The following three features are integrated into AT-50B.

- Control up to 50 indoor units from one location
- A weekly programmable timer, being able to control up to 50 indoor units
- Control up to 50 units/50 groups of air conditioners

### Weekly and daily schedule

5 patterns of one day and 12 patterns of weekly schedule (16 settings max. per pattern).

Two types of weekly schedule can be set.

### System changeover

Operation mode can be switched depending on indoor temperature setting and target temperature of each group or a representative indoor unit.

## Functions

### [Basic Functions]

- ON/OFF   ▪ Operation mode switching
- Temperature setting   ▪ Fan speed setting
- Airflow direction setting   ▪ Louver setting

### Night setback function

This function allows having a two-temperature setting to keep the desired room temperature when the units are not in operation and during the time this function is effective.

The unit automatically starts heating (cooling) operation when the temperature drops below (rises above) the preset lower (upper) limit temperature. This is not only for comfort environment, but also for saving energy.

### Main system controller/Sub system controller

AT-50B can be set to Sub System controller.

When connecting multiple system controllers, designate the system controller with many functions as the "Main", and set the system controllers with few functions as the "Sub".

### Simple button arrangement

The F1 (Function 1) and the F2 (Function 2) button can be set as a run button of the following collective operation. (Setback/Schedule/Operation Mode/Temperature Correction/Remote Controller Prohibition)

## Advanced Functions

□: Each unit   ○: Each group   ◎: Group or collective   ×: Not available			
Item	Description	Operations	Display
Permit / Prohibit	The ON/OFF, operation mode, setting temperature, fan speed, air direction, filter sign reset operations, and timer using the local remote controllers can be prohibited. Only ON/OFF and filter reset can be prohibited for the LOSSNAY group. *The settable items vary depending on the models.	◎	◎
Operation lock	The operation lock can be set to the input operation of AT-50B. Each button can be set. (Function Button 1, Function Button 2, Collective ON/OFF, Touch Panel) Each function can be set. (Operation mode, Setting temperature, Fan speed, Menu button) The password for the lock release can be set.	◎	◎
Error display	When an error is currently occurring on an air conditioner unit, the afflicted unit and the error code are displayed. * When an error occurs, the "ON/OFF" LED flashes. The operation monitor screen show abnormal icon over the unit. The error monitor screen shows the abnormal unit address and error code. The error log monitor screen shows the time and date, the abnormal unit address, error code and source of detection.	×	□◎
Ventilation (independent)	Switches the mode "Bypass/Heat recovery/Auto" for LOSSNAY groups.	◎	◎
Ventilation (interlocked)	The LOSSNAY will run in interlock with the operation of indoor unit. The mode cannot be changed. The LED will turn ON during operation after interlocking.	◎	◎
Temperature-set limitation	Batch-setting to temperature range limit at cooling, heating, and auto mode. This function cannot be used with the MA remote controller. (Depends on the indoor unit model.)	◎	◎
Specific mode operation prohibit (Cooling prohibit, heating prohibit, cooling/heating prohibit)	When set as the main controller, operation of the following modes with the local remote controllers can be prohibited. When cooling is prohibited: Cooling, dry, automatic can not be chosen. When heating is prohibited: Heating, automatic can not be chosen. When cooling/heating is prohibited: Cooling, dry, heating, automatic can not be chosen.	◎	◎
External input (Emergency stop input, etc.)	The following input with level signals or pulse signals are available. Level signal: "Emergency stop input" or "Collective ON/OFF" Pulse signal: "Collective ON/OFF" or "Local remote controller prohibit/permit" One input can be selected from those above. * An external input/output adapter (PAC-YT41HAA (sold separately)) is required. Relays and DC power supply or other devices must be prepared at the site.	◎	◎
External output (Error output, operation output)	"ON/OFF" and "error/normal" are output with the level signal. * An external input/output adapter (PAC-YT41HAA, PAC-YT51HAA (sold separately)) is required. Relays and DC power supply or other devices must be prepared at the site.	◎	◎
Checking the Gas Amount	Use this function to check for refrigerant leak from the outdoor unit. * When this function is used, the gas amount checking function of the outdoor unit cannot be used. This function is for CITY MULTI R2 and Y (PUMY is excluded.) series only.	□	□
Schedule operation	Weekly schedule setting up to 12 pattern is available. In one pattern, up to 16 setting of "ON/OFF", "Operation mode", "Set Temperature", "Fan speed", "Air flow direction" and "Permit / Prohibit local operation" can be scheduled. Two types of weekly schedule(Summer/Winter) can be set. Today's schedule setting up to 5 pattern is available.	○	○

\* Depending on the installation conditions, power supply unit (PAC-SC51KUA) is required. Please contact your local distributor or MITSUBISHI ELECTRIC branch office for further information.

## Remote Controller

# Centralized Remote Controller

**NEW**

## Centralized controller AE-200E/AE-50E



**Dual Set Point**

Dimensions: 284(W) x 200(H) x 65(D) mm  
: 11-5/32(W) x 7-27/32(H) x 2-9/16(D) in.

- By comprehensively showing the energy consumption of air-conditioning equipment, it provides assistance in energy efficiency.
- Energy consumption of air-conditioning equipment by individual area is displayed using graphs for easier viewing.
- Enables comparisons with the previous year's power consumption as well as with the target electric power, thus allowing users to check the operating state at a glance.
- Floor layout is displayed on the 10.4-inch LCD touch panel, facilitating easier operation of air-conditioning equipment.
- In an easy and flexible manner, an optimum system can be established according to the scale of facilities.
- Implements control on up to 50 indoor units of air-conditioning equipment.
- By using three units of expansion controller "AE-50E", the centralized control is implemented for the maximum of 200 indoor units.

### Control Screen for Power Consumption



Energy consumption of applicable area is displayed by the month, day, and hour. Energy consumption of two different units, groups and blocks can be compared. Fan operation time as well as energy consumption can be displayed.

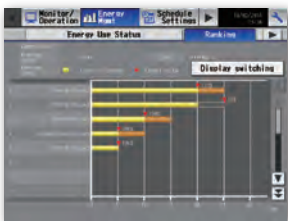

Energy consumptions of air-conditioning equipment are ranked and displayed by individual air-conditioning equipment and by area, thus visualizing high-load components. Also, comparison of energy consumption with target electric energy is possible.

- Features for operating and monitoring the hot water heat pump are also available on PWFY.
- Centralized batch control on PWFY is possible in addition to that on air-conditioning unit.

### Comparison in the number of connectable units

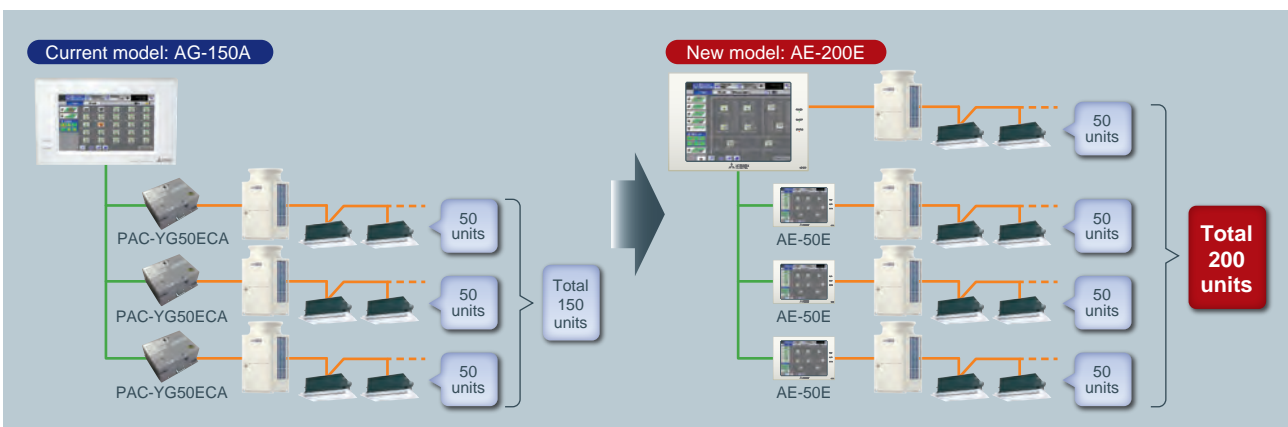

## System Structure

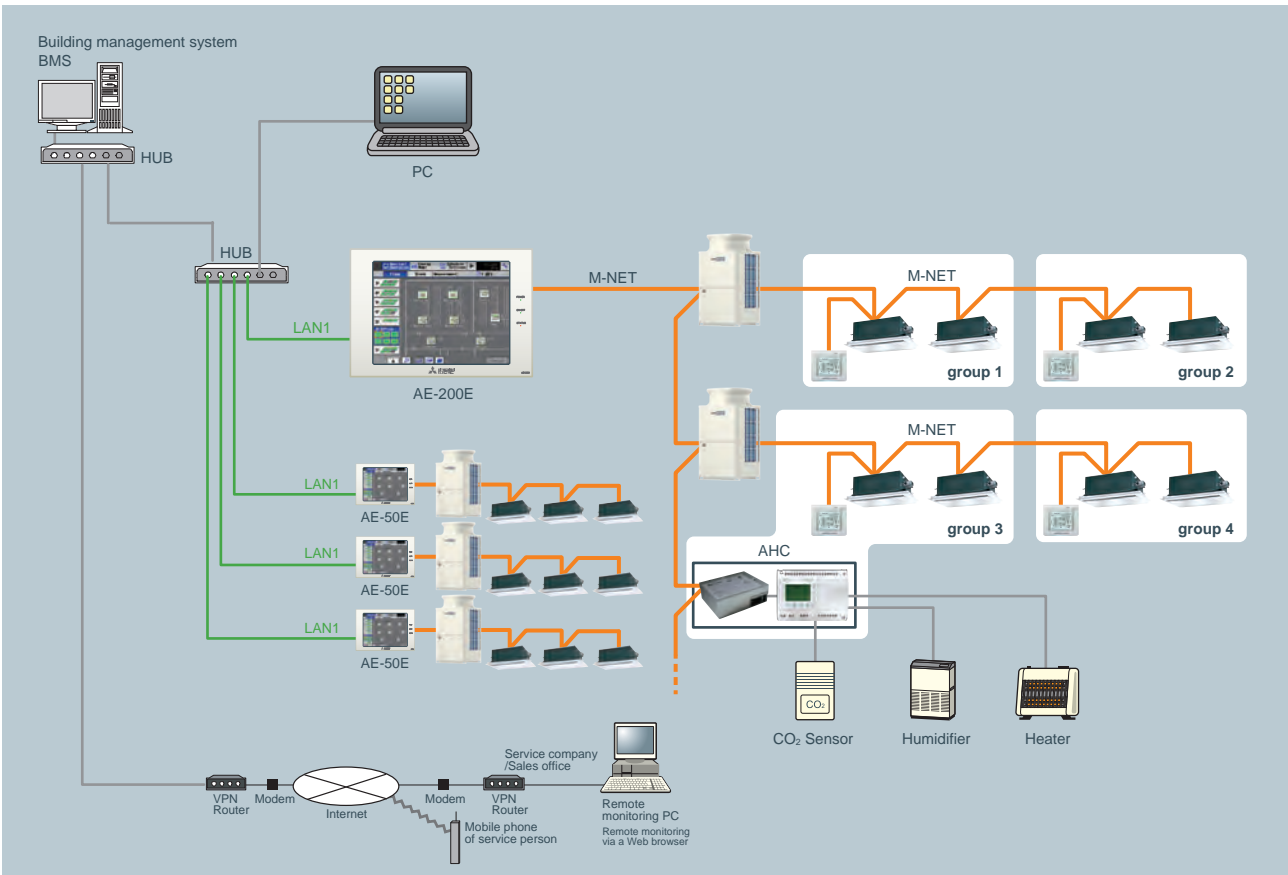

## Functions

Item	Description	Operations	Display
Controllable number of unit	Up to 50 units/50 groups		
ON/OFF	ON and OFF operation for the air conditioning units and general equipment. (To operate general equipment, PAC-YG66DCA is required.)	○ ○ △ ●	○ ○
Operation mode	Switches between several operation modes depending on the air conditioning unit. Air conditioning unit : Cool/Dry/Auto(*)/Fan/Heat LOSSNAY unit : Heat Recovery/Bypass/Auto Air To Water (PWFY) units : Heating, Heating ECO, Hot Water, Anti-freeze, Cooling(**) * Auto mode is for CITY MULTI R2 and WR2 series only. ** Only PWFY	○ ○ △ ●	○
Temperature setting	Cool/Dry : 19°C (67°F) -35°C (95°F) [14°C (57°F) -30°C (87°F)] Heat : 4.5°C (40°F) -28°C (83°F) [17°C (63°F) -28°C (83°F)] Auto : 19°C (67°F) -28°C (83°F) [17°C (63°F) -28°C (83°F)] The range of temperature depends on the air conditioning unit. [ ] in case of using middle-temperature on PDFY, PEFY-VML/VMR/VMS/VMH-by setting DipSW7-1 to ON. Yet, PEFY-P-VMH-E-F is excluded.	○ ○ △ ●	○
Fan speed setting	Models with 4 air flow speed settings : Hi/Mid-2/Mid-1/Low Models with 3 air flow speed settings : Hi/Mid/Low Models with 2 air flow speed settings : Hi/Low Fan speed setting (including Auto) varies depending on the model.	○ ○ △ ●	○
Air flow direction setting	Air flow direction angles, 4-angles or 5-angles Swing, Auto (Louver cannot be set)	○ ○ △ ●	○
Schedule operation	Weekly schedule can be set by groups based on daily operation pattern.	○ ○ △ ●	○
Permit/prohibit local operation	Individually prohibits operation of each local remote controller function. (ON/OFF, Operation mode, Set temperature, Filter sign reset, Air Direction*, Fan Speed*, Timer*) * This function depends on the model.	○ ○ △ ●	○
Indoor unit intake temperature	Measures the intake temperature of the indoor unit only when the indoor unit is operating.	×	○
Error	When an error is currently occurring on an air conditioning unit, the afflicted unit and the error code are displayed.	×	□ ○
Test run	This operates air conditioning units in test run mode.	○ ○ △ ●	○
Ventilation interlock	The ventilation unit (LOSSNAY) is able to automatically start its operation when operation of the interlocked indoor unit starts.	○ ○ △ ●	○
External input/output	By using optional external input/output adapter (PAC-YG10HA-E) you can set and monitor the following. Input : By level signal : "Batch ON/OFF", "Batch emergency stop" By pulse signal : "Batch ON/OFF", "Enable/disable local remote controller" Output : "ON/OFF", "Error/Normal"	○	○
Energy Management	Bar Graph : Indoor unit Electric Energy, FAN operation time, Thermo-ON time (TOTAL, Cooling, Heating) can be displayed hourly, daily and monthly. Line Graph : Outdoor temp., Room temp., Set temp. (Heating, Cooling) input from PAC-YG63MCA and temp. from AHC.	×	□ ○ ●
Advanced HVAC Controller (AHC)	The status of AHC can only be monitored.	×	○
New Smart ME controller	The status of sensor on this controller can be monitored.	×	○



# Centralized Remote Controller

With a new coloured touch panel, and continuation of all the G-50A functions, AG-150A visualizes its functions from basic control to advanced operations and bringing an ultimate controller to reality.

## Centralized controller AG-150A



Dimensions: 300(W) x 185(H) x 70.3(D) mm  
: 11-13/16(W) x 7-5/16(H) x 2-13/16(D) in.



Option : Black surface cover  
PAC-YG71CBL

### System structure

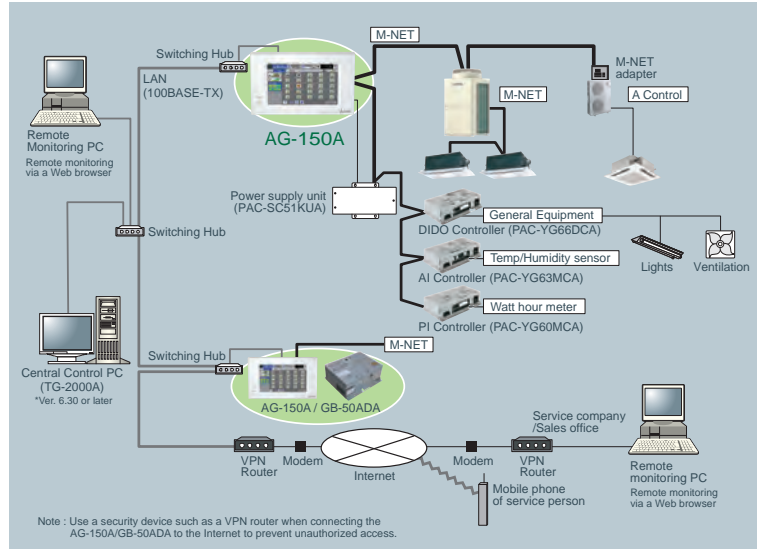

## Expansion Controller PAC-YG50ECA



Dimensions: 250(W) x 217(H) x 97.2(D) mm  
: 9-7/8(W) x 8-9/16(H) x 3-7/8(D) in.

With a connection of a Expansion Controller, maximum of 150 units/groups can be connected to AG-150A.

### System structure

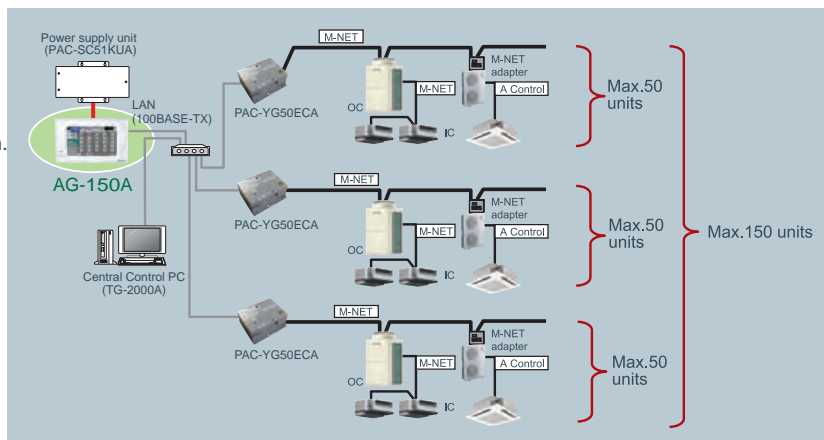

\*Do not connect PAC-YG50ECA to TB3 of the outdoor unit.

\*Use a security device such as a VPN router when connecting the AG-150A etc. to the Internet to prevent unauthorized access.



## Design

### Backlight color liquid crystal

Backlight makes it easy to see and control units.  
One can identify whether a unit is ON or OFF from a distance.  
Control in the night with no lights is possible.

### Touch panel

#### 9 inch wide, high-resolution

Touch panel enables operation of units by touching with index finger.  
When object unit is touched, orange box appears around the unit icon indicating the unit selected.

### Flat back

#### Easy installation

Allows for an installation of the unit either directly to the wall surface\* or using the installation hole in the wall.  
\*Optional parts are required.

### USB memory compatible

Measurement/initial setting CSV data extractable with USB memory.  
Can save and overwrite setting data.

## Functions

### Controllable units/groups

Controls up to 50 units/groups (including indoor units, LOSSNAY, DIDO/AI/PI controller)  
Up to 150 units can be controlled via expansion controller; PAC-YG50ECA (AG-150A software needs to be upgraded to Ver. 2.10 or later.)

### Monitoring functions

Temperature/Humidity (using AI controller)  
General equipment such as lights on LCD (using DIDO controller)  
Interlock function from AI controller, DIDO controller to indoor units and between DIDO units are available.  
AG-150A interlock with DIDO controller or free contact on an indoor unit available. \* Ver. 2.30 or later

### Energy saving functions

Seasonal scheduling and automatic switch over \*1  
Yearly scheduling on LCD \*1  
Scheduling fan speed and airflow direction  
Optimized Start up  
External temperature interlock control  
Night setback control  
\*1 License required.

## Functions

□ : Each unit   ○ : Each group   ● : Each block   △ : Each floor   ◎ : Collective   × : Not available			
Item	Description	Operations	Display
Controllable unit	50 units/groups or 150 units/groups via expansion controller; PAC-YG50ECA.		
ON/OFF	Run and stop operation for the air conditioner units and general equipment. (To operate general equipment, PAC-YG66DCA is required.)	○ ◎ △ ●	○ ◎
Mode selection	Switches between Cool / Dry / Auto / Fan / Heat. (Group of LOSSNAY unit : automatic ventilation/ vent - heat interchange/ normal ventilation) depending on the air conditioner unit. Auto mode is for CITY MULTI R2 and WR2 series only.	○ ◎ △ ●	○
Temperature setting	Cool/Dry : 19°C-30°C (14°C-30°C) / 67°F-87°F (57°F-87°F) Heat : 17°C-28°C (17°C-28°C) / 63°F-83°F (63°F-83°F) Auto : 19°C-28°C (17°C-28°C) / 63°F-83°F (63°F-83°F) ( ) in case of using middle-temperature on PEFY-VML/VMR/VMS/VMH by setting DipSW7-1 to ON. Yet, PEFY-P-VMH-E-F is excluded.	○ ◎ △ ●	○
Fan speed setting	Models with 4 air flow speed settings: Hi/Mid-2/Mid-1/Low Models with 3 air flow speed settings: Hi/Mid/Low Models with 2 air flow speed settings: Hi/Low Fan speed setting (including Auto) varies depending on the model.	○ ◎ △ ●	○
Air flow direction setting	Air flow direction angles, 4-angle or 5-angle Swing, Auto (Louver cannot be set)	○ ◎ △ ●	○
Schedule operation	Annau/Weekly (5 types)/today schedule can be set for each group of air conditioning units. Optimized startup setting is also available.	○ ◎ △ ●	○
Permit / Prohibit local operation	Individually prohibit operation of each local remote control function (Start/Stop, Change operation mode, Set temperature, Reset filter).	○ ◎ △ ●	○
Indoor unit intake temperature	Measures the intake temperature of the indoor unit only when the indoor unit is operating.	×	○
Error	When an error is currently occurring on an air conditioner unit, the afflicted unit and the error code are displayed.	×	□ ◎
Test run	This operates air conditioner units in test run mode.	○ ◎ △ ●	○
Ventilation interlock	The ventilation unit (LOSSNAY) is able to automatically start its operation when operation of the interlocked indoor unit starts.	○ ◎ △ ●	○
External input/output	By using optional external input/output adaptor (PAC-YG10HA) you can set and monitor the following. Input : By level signal : "Batch start/stop", "Batch emergency stop" By pulse signal : "Batch start/stop", "Enable/disable local remote controller" Output : "Start/stop", "Error/Normal"	◎	◎

\*NOTE: Operation and displayed content vary depending on the indoor unit model.  
◆Future release schedule is subject to change without notice.



Remote Controller

# Centralized Remote Controller

Just press a switch to start. All of the units can be On/Off by pressing the main switch, and each unit in the group can be On/Off with individual switch. The PAC-YT40ANRA also has hardwired connection available (On/Off input, fire alarm input, run output, fault output).

## ON/OFF remote controller PAC-YT40ANRA



- The group setting is kept in nonvolatile memory. No need to worry about re-setting at power failure.
- No individual AC power supply is needed. The power can be supplied from one outdoor unit (R410A) or Power supply unit.

Dimensions: 130(W) x 120(H) x 19(D) mm  
: 5-1/8(W) x 4-23/32(H) x 3/4(D) in.

### System example

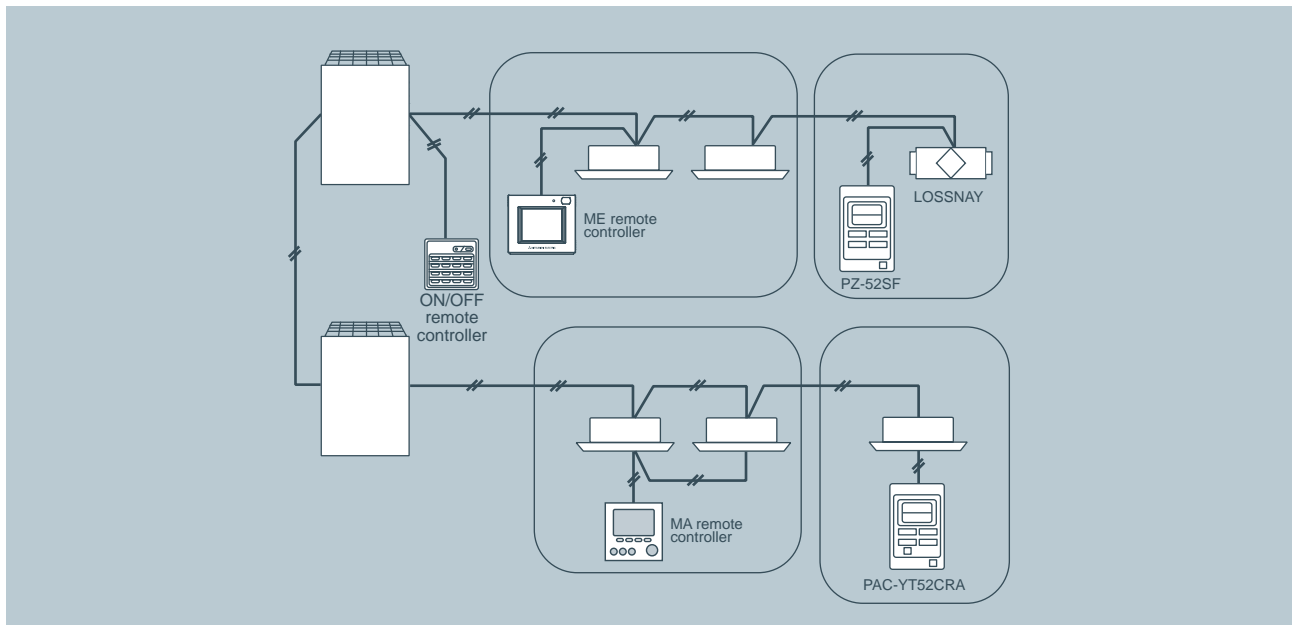

FUNCTION	DESCRIPTION	PAC-YT40ANRA	
UNITS	Max No.Units	50 units/16 groups	
		OPERATIONS	DISPLAY
ON/OFF	Run and stop operation	✓	✓
ERROR INDICATION	LED flashes during failure. (The error code can be confirmed by removing the cover.)	—	✓
VENTILATION OPERATION (INDEPENDENT)	Group operation of only LOSSNAY units possible. *Only ON/OFF of group.	✓	✓
VENTILATION OPERATION (INTERLOCKED)	The LOSSNAY will run in interlock with the operation of indoor unit. *The fan rate and mode cannot be changed. The LED will turn ON only during operation after interlocking.	✓	✓
EXTERNAL INPUT	On/Off/Fire Alarm *	✓	—
EXTERNAL OUTPUT	On/Off/Faults *	—	✓

\* Applicable to collective only  
Not applicable to groups

Remote Controller



## AHC ADAPTER PAC-IF01AHC-J



Dimensions: 116(W) x 90(H) x 40(D) mm  
: 4-9/16(W) x 3-1/2(H) x 1-9/16(D) in.

Advanced HVAC CONTROLLER (hereafter referred to as AHC) comprises of MITSUBISHI ELECTRIC's AHC ADAPTER (PAC-IF01AHC-J) and  $\alpha$ 2 SIMPLE APPLICATION CONTROLLER\* (hereafter referred to as ALPHA2).

\* $\alpha$ 2 SIMPLE APPLICATION CONTROLLER is one of the Programming Logic Controllers that are manufactured by MITSUBISHI ELECTRIC CORPORATION.

AHC allows for the connection of MITSUBISHI ELECTRIC's air conditioning network system (hereafter referred to as M-NET) to other systems, which was not possible with the use of ALPHA2 alone. AHC provides the following functions.

- ① Controls external devices using the sensor data of the air conditioning units connected to M-NET.
- ② Interlocks the operation of air conditioning units and external devices that are connected to ALPHA2.
- ③ Controls air conditioning units that are connected to M-NET.
- ④ Allows for the combined use of the items ①-③ above.
- ⑤ Monitors the input/output status of ALPHA2 via a remote controller or a centralized controller.

### Compatible controllers

- Remote Controller: PAR-U02MEDA
- Centralized Controller: EB-50GU-J

\* Refer to the manual that came with ALPHA2 for information about ALPHA2.

\* The use of AHC ADAPTER requires either a remote controller or a centralized controller.

### System Structure

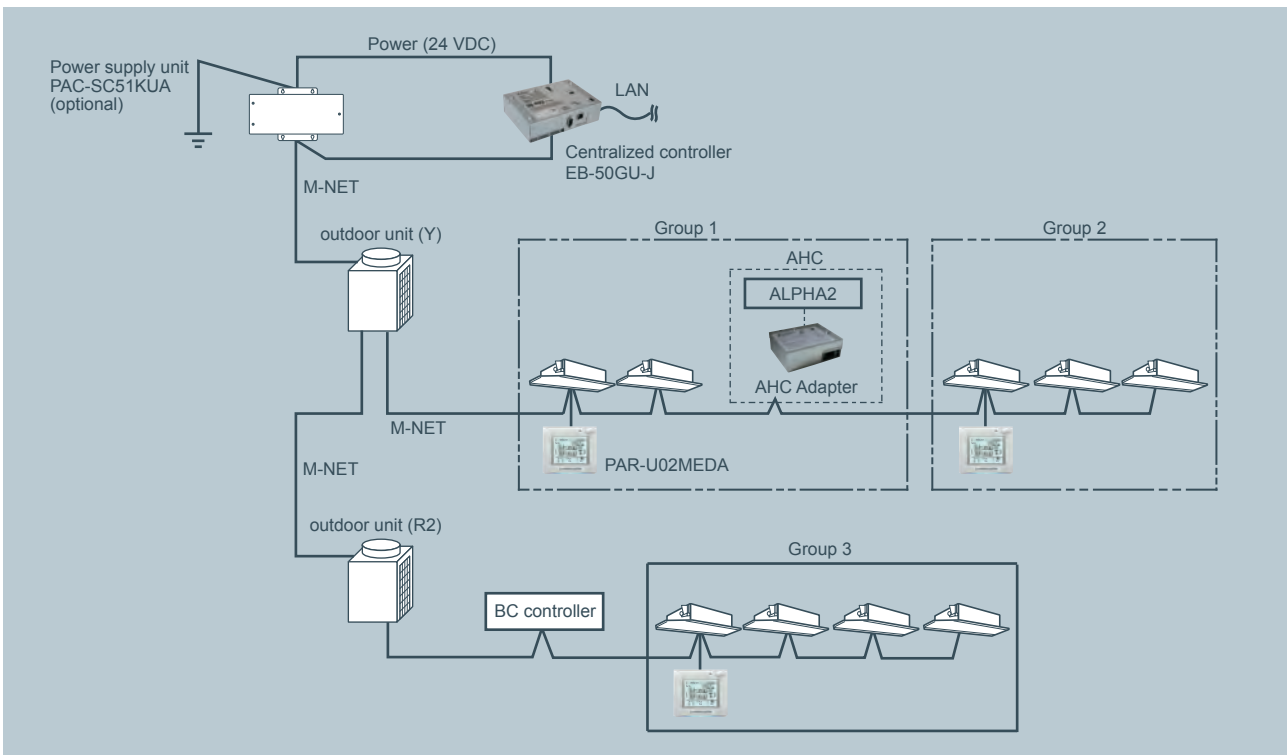

Remote Controller



# Centralized Remote Controller

## PI Controller PAC-YG60MCA



Dimension: 200(W) x 120(H) x 45(D) mm  
: 7-7/8(W) x 4-3/4(H) x 1-13/16(D) in.

**No more PLCs are needed!**

Our new PI controller makes it possible to perform energy saving without PLC, which is cost saving. Maximum of 4 measurement meter (WHM, gas meter, water meter, calorie meter) can be connected to the PI controller and can be used also for charge calculation.

\*24 VDC power needs to be provided on site.

## Energy Saving Control (Peak Cut)

Enables Energy Saving Control with the use of our new PI controller. (Registration of "Energy Management license pack" is required.)

To perform energy saving, the capacity of the outdoor unit is controlled.

\*Please note that when using an energy saving control, there are no warranties to failures such as usage over the contracted electricity.

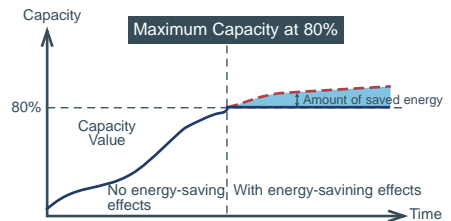

## System Structure

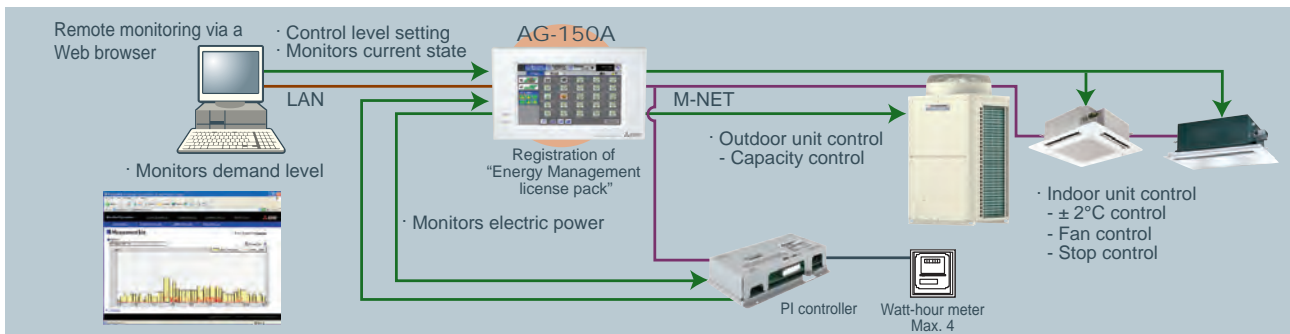

## Charge Calculation

Enables charge calculation for each tenant and output as CSV file

## System Structure

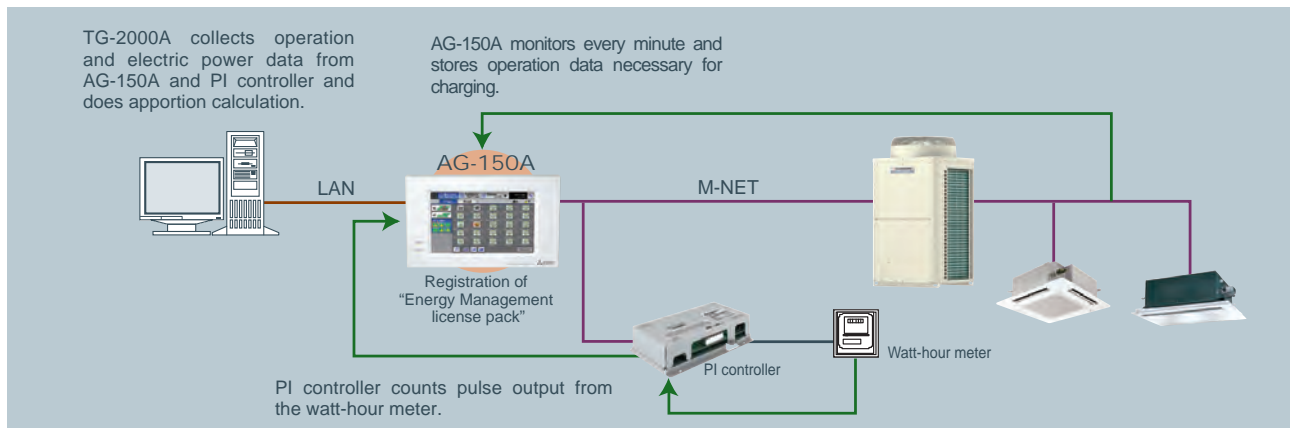

## DIDO Controller PAC-YG66DCA



Dimension: 200(W) x 120(H) x 45(D) mm  
: 7-7/8(W) x 4-3/4(H) x 1-13/16(D) in.

**No more PLCs are needed!**

Our new DIDO controller makes it possible to control general-purpose equipment without PLC, which is cost saving. Up to 6 general-purpose equipment can be connected to the DIDO controller.

\*24 VDC power needs to be provided on site.

### General-purpose equipment Control

Enables to control and monitor equipment other than air-conditioners (air-conditioners of other companies, lights, ventilators, etc.)

#### System Structure

- In addition to above, the air-conditioners can be interlocked with general-purpose equipment. E.g. Interlock between indoor units and security system.
- The indoor units can be turned ON/OFF when the security system is activated/deactivated.

#### Icon display (Lights)

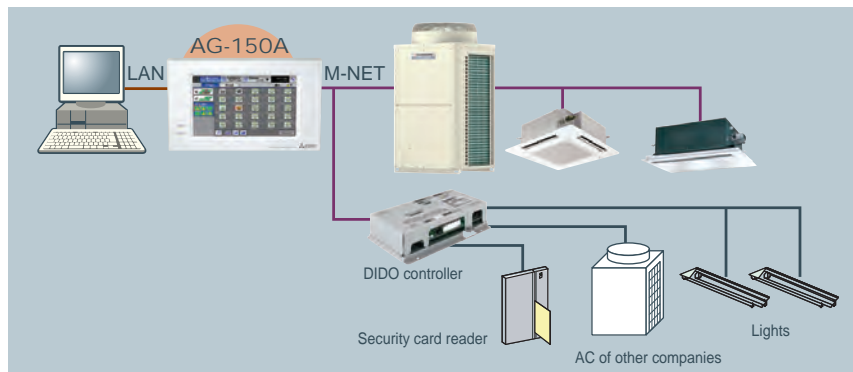

## AI Controller PAC-YG63MCA



Dimension: 200(W) x 120(H) x 45(D) mm  
: 7-7/8(W) x 4-3/4(H) x 1-13/16(D) in.

Our new AI controller makes it possible to monitor the values measured by the temperature/humidity sensor connected to the AI controller.

The AI controller has two input and two output channels.

\*24 VDC power needs to be provided on site.

### Temperature/Humidity Monitoring

Monitors the values measured by the temperature/humidity sensor connected to the AI controller

Temperature : Pt100, 4 to 20mA DC, 1 to 5 VDC, 0 to 10 VDC  
Humidity : 4 to 20mA DC, 1 to 5 VDC, 0 to 10 VDC

- Trend displays of measurement data can be shown on a Web browser.

#### System Structure

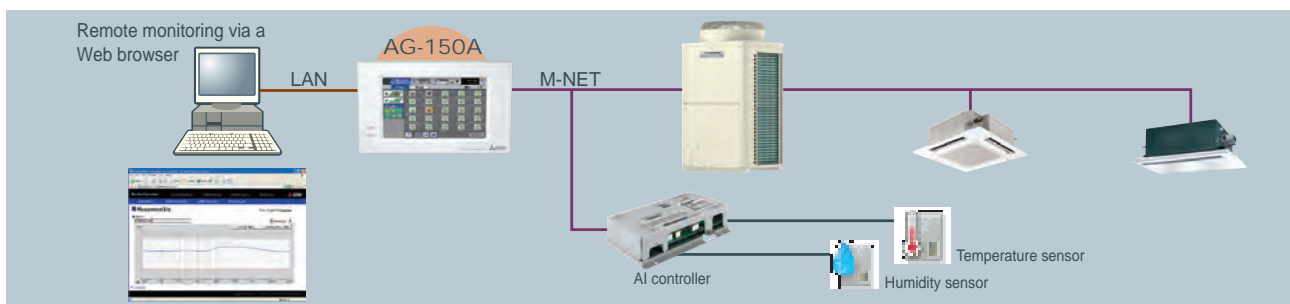

Remote Controller

# Centralized Remote Controller

## Integrated centralized control software TG-2000A



### Example of Basic System Configuration

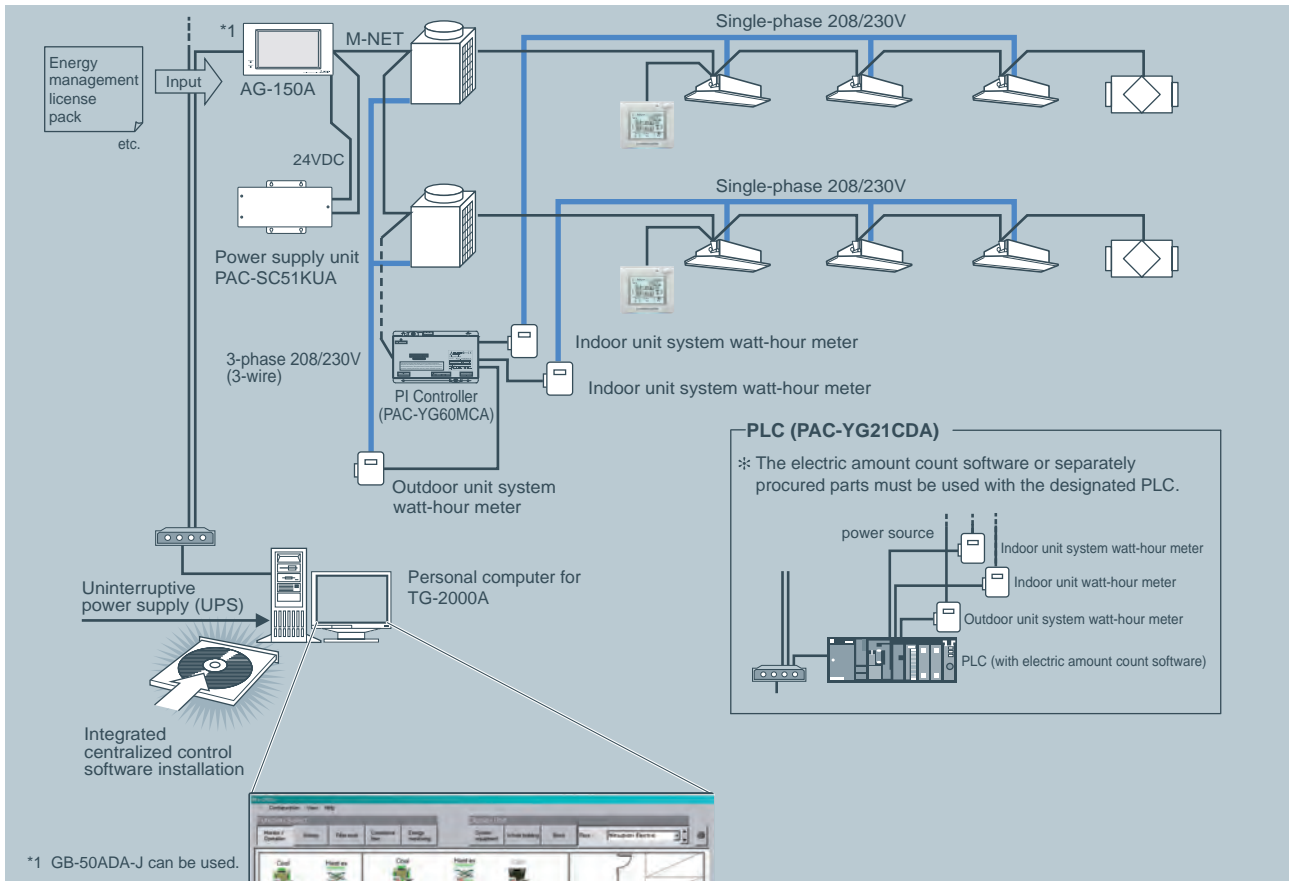

The air-conditioning layout can be displayed on the screen, making control and operation easier.

### Effective use of TG-2000A

Multiple air conditioning charges in multiple buildings can be calculated. The power apportionment percentage data and apportioned power rate can be calculated for each unit, and can be output as a CSV file.



For example, installing TG-2000A to the system in the headquarters makes it possible to control AG-150A/GB-50ADA-J units that are used in branch offices.



## LONWORKS® (LMAP04)

CITY MULTI can easily combine into a Building Management System (BMS) via the LonWorks and M-NET adapter LMAP04. LonWorks® is an opened transmission protocol widely used at BMS, and related equipment control. CITY MULTI is therefore compatible with large-scaled BMS management via LonWorks®.

**One LM ADAPTER unit can connect up to 50 Groups/50 indoor units.**

Using a single LonWorks® adapter (LM-AP), you can connect up to a maximum of 50 indoor units.

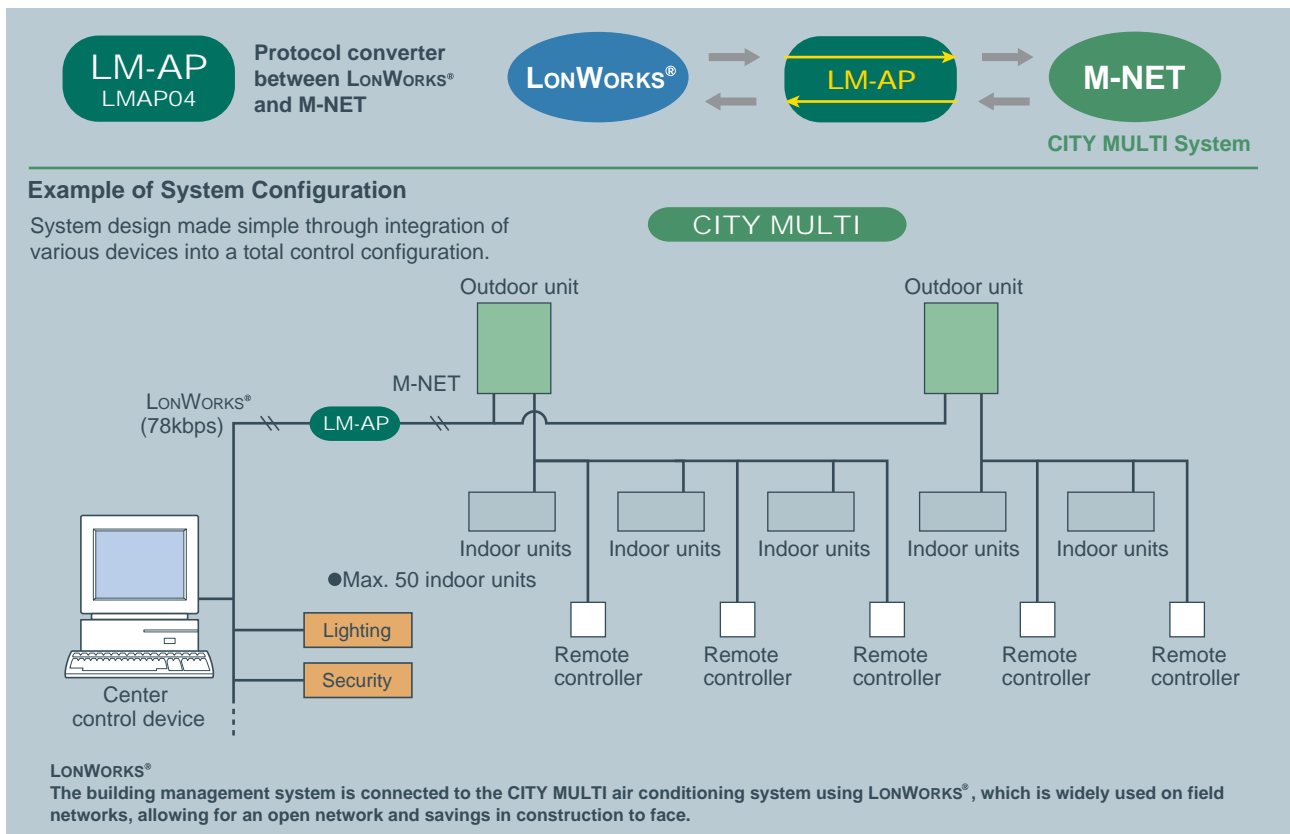

LON, LONWORKS® and the Echelon logo are trademarks of Echelon Corporation registered in the United States and other countries.

### LONWORKS® INTERFACE

FUNCTION	CONTENT
<b>Control</b>	
ON/OFF	Run/Stop
Mode Operation	Cooling/Drying/Heating/Auto/Fan/Setback
Setpoint Adjustment	Cooling 19-35°C, Heating 4.5-28°C, Auto 19-28°C
Fan Speed Control	Lo-Mi1-Mi2-Hi
Permit/Prohibit	ON/OFF, Mode, Setpoint
Emergency Stop	-
<b>Monitoring</b>	
ON/OFF	Run/Stop
Mode	Cooling/Drying/Heating/Auto/Fan/Setback
Setpoint	Cooling 19-35°C, Heating 4.5-28°C, Auto 19-28°C
Fan Speed	Lo-Mi1-Mi2-Hi
Permit/Prohibit	ON/OFF, Mode, Setpoint
Alarm State	Normal/Abnormal
Room Temperature	-10°C~50°C
Thermo ON/OFF	ON/OFF



# Centralized Remote Controller

## BACnet® (BAC-HD150)

CITY MULTI can easily combine into a Building Management System (BMS) via the BACnet® and M-NET adapter BAC-HD150. BACnet® is an opened transmission protocol widely used at BMS, and related equipment control. CITY MULTI is therefore compatible with large-scaled BMS management via BACnet®.

**BAC-HD150 can control up to 50 units/groups (including LOSSNAY).**

**Up to 150 units/groups (including LOSSNAY) can be controlled from one BAC-HD150 with three expansion controllers PAC-YG50ECA. (50 units/PAC-YG50ECA)**

**When the dual-set-point function is used, no expansion controllers can be connected, and only up to 50 units/groups can be controlled from each BAC-HD150.**

System example (Connection of 150 units / groups with PAC-YG50ECA)

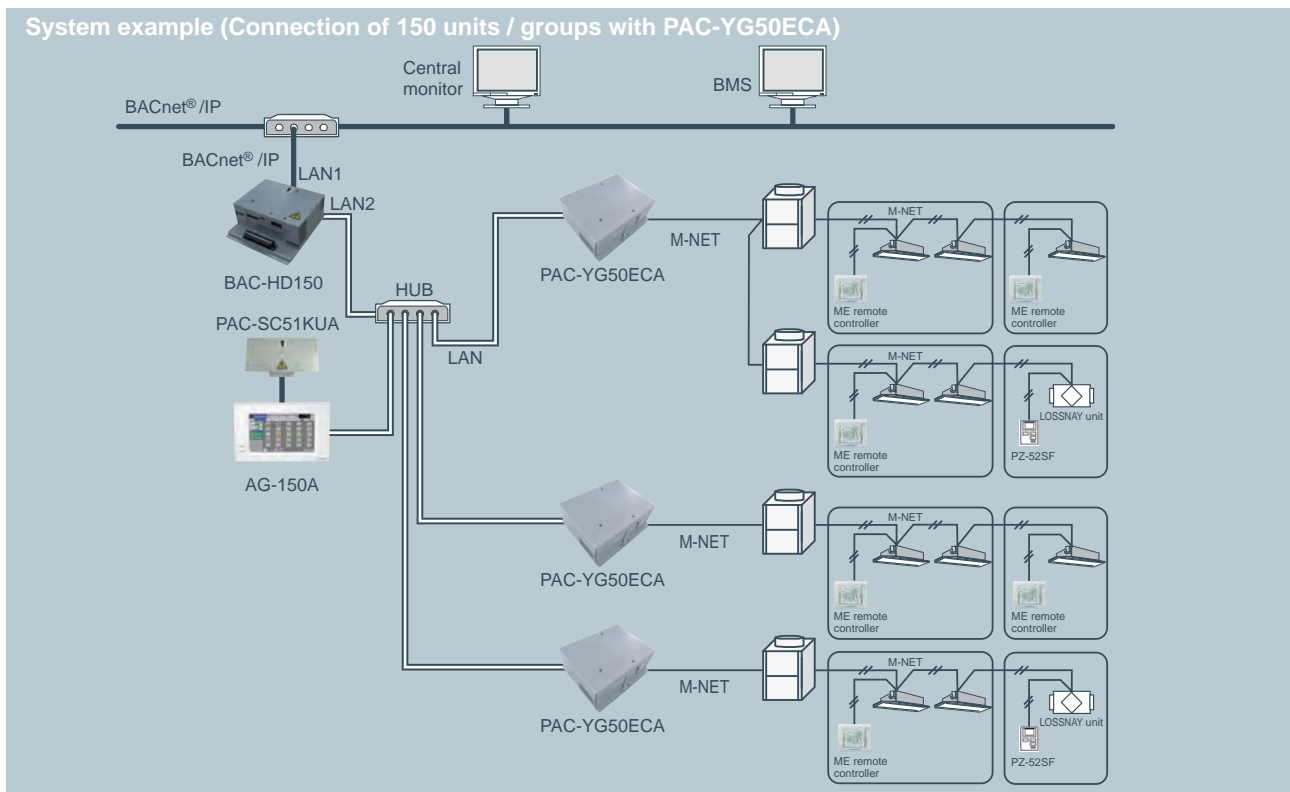

## BACnet® and M-NET adapter

FUNCTION	CONTENT
<b>Operation</b>	
ON/OFF	Run/Stop
Mode	Cool/Dry/Heat/Auto/Fan/Setback
Fan Speed	Low-Mid1-Mid2-Hi
Airflow Direction	Horizontal- 60°-80°-100°swing
Set Temperature	Cooling 19-35°C [67-95°F], Heating 4.5-28°C [40-83°F], Auto 19-28°C [67-83°F]
Filter Sign Reset	Normal/Reset
Permit/Prohibit	ON/OFF, Mode, Filter sign reset, Set temp.
Forced OFF	Release/Effective
<b>Monitoring</b>	
ON/OFF	Run/Stop
Mode	Cool/Dry/Heat/Fan/Setback
Fan Speed	Low-Mid1-Mid2-Hi
Air Direction	Horizontal- 60°-80°-100°swing
Set Temperature	Cooling 19-35°C [67-95°F], Heating 4.5-28°C [40-83°F], Auto 19-28°C [67-83°F]
Filter Sign	Normal/Reset
Permit/Prohibit	ON/OFF, Mode, Filter sign reset, Set temp.
Indoor Temperature	-
Alarm Signal	Normal/Abnormal
Error Code	2 Character code- Indicates all unit alarms
Communication State	Normal/Abnormal





# Optional Parts



# OPTIONAL PARTS FOR INDOOR UNITS

## >>4-way cassette type (PLFY-VBM/VCM)

Description	Model	Applicable capacity	
		VBM	VCM
Decoration panel	SLP-2AAW/SLP-2ALW	–	P20, P25, P32, P40
Automatic Filter Elevation Panel	PLP-6BAJ	P20, P25, P32, P40, P50, P63, P80, P100, P125	–
Multi-functional casement	PAC-SH63TM-E	P20, P25, P32, P40, P50, P63, P80, P100, P125	–
High-efficiency filter element	PAC-SH69KF-E	P20, P25, P32, P40, P50, P63, P80, P100, P125	–
Wireless signal receiver	PAR-SA9FA-E	P20, P25, P32, P40, P50, P63, P80, P100, P125	–
Space panel	PAC-SH48AS-E	P20, P25, P32, P40, P50, P63, P80, P100, P125	–
"i-see" sensor	PAC-SA1ME-E	P20, P25, P32, P40, P50, P63, P80, P100, P125	–
Duct flange for fresh air intake	PAC-SH65OF-E	P20, P25, P32, P40, P50, P63, P80, P100, P125	–
Shutter plate	PAC-SH51SP-E	P20, P25, P32, P40, P50, P63, P80, P100, P125	–

## >>2-way cassette type (PLFY-VLMD)

Description	Model	Applicable capacity
Decoration panel	CMP-40VLW-C	P20, P25, P32, P40
	CMP-63VLW-C	P50, P63
	CMP-100VLW-C	P80, P100
	CMP-125VLW-C	P125
OA duct flange	PAC-KH11OF	P20, P25, P32, P40, P50, P63, P80, P100

## >>1-way cassette type(PMFY-VBM)

Description	Model	Applicable capacity
Decoration panel	PMP-40BM	P20, P25, P32, P40

## >>Ceiling concealed type (PEFY-VMH(S))

Description	Model	Applicable capacity	Remarks
Drain pump	PAC-KE04DM-F	P40-P250	For VMH models
	PAC-KE05DM-F	P200, P250	For VMHS models
Long life filter	PAC-KE86LAF	P40, P50, P63	–
	PAC-KE88LAF	P71, P80	–
	PAC-KE89LAF	P100, P125, P140	–
	PAC-KE85LAF	P200, P250	–
	PAC-KE63TB-F	P40, P50, P63	Necessary when long life filter is used
PAC-KE80TB-F	P71, P80		
PAC-KE140TB-F	P100, P125, P140		
PAC-KE250TB-F	P200, P250		

## >>Ceiling concealed type (PEFY-VMA(L))

Description	Model	Applicable capacity
Filter box	PAC-KE91TB-E	P20, P25, P32
	PAC-KE92TB-E	P40, P50
	PAC-KE93TB-E	P63, P71, P80
	PAC-KE94TB-E	P100, P125
	PAC-KE95TB-E	P140

## >>Fresh air intake type (PEFY-VMH-E-F)

Description	Model	Applicable capacity
Long life filter	PAC-KE88LAF	P80
	PAC-KE89LAF	P140
	PAC-KE85LAF	P200, P250
Filter box	PAC-KE80TB-F	P80
	PAC-KE140TB-F	P140
	PAC-KE250TB-F	P200/P250
Drain pump	PAC-KE04DM-F	P80, P140, P200, P250

## >>Ceiling suspended type (PCFY-VKM)

Description	Model	Applicable capacity
Drain pump kit	PAC-SH83DM-E	P40
	PAC-SH84DM-E	P63, 100, 125
High efficiency filter	PAC-SH88KF-E	P40
	PAC-SH89KF-E	P63
	PAC-SH90KF-E	P100, 125
Wireless remote controller kit	PAR-SL94B-E	P40, 63, 100, 125

## >>Ceiling concealed type (PEFY-VMS1(L))

Description	Model	Applicable capacity	
Drain pump	PAC-KE07DM-E	P15, 20, 25, 32, 40, 50, 63	*For PEFY-VMS1L only
Control box replace kit	PAC-KE70HS-E	P15, 20, 25, 32, 40, 50, 63	

## >>Wall mounted type (PKFY-VBM/VHM/VKM)

Description	Model	Applicable capacity
External LEV Box	PAC-SG95LE-E	P15, 20, 25, 32, 40, 50, 63
Drain pump kit	PAC-SH75DM-E	P32, 40, 50
	PAC-SH94DM-E	P63, 100



# OPTIONAL PARTS FOR OUTDOOR UNITS

## >>For PUMY series

Description	Model
Branch Pipe (2 Branch)	CMY-Y62-G-E
Header	CMY-Y64-G-E
Header	CMY-Y68-G-E
Drain Socket	PAC-SG61DS-E
Centralized Drain Pan	PAC-SH97DP-E
Port Connector (ø9.52 → ø12.7)	PAC-SG73RJ-E
Port Connector (ø15.88 → ø19.05)	PAC-SG75RJ-E
Air Protect Guide (2 pcs required)	PAC-SH95AG-E
Air Outlet Guide	PAC-SH96SG-E

## >>For PUHY series

Description	Model	Remarks
Twinning kit	CMY-Y100VBK3	For PUHY-P400-P650YSKB / EP500-EP600YSLM
	CMY-Y200VBK2	For PUHY-P700-P900YSKB
	CMY-Y300VBK3	For PUHY-P950-P1350YSKB / EP650-EP1350YSLM
Branch pipe (Joint)	CMY-Y102SS-G2	200 or below (Total capacity of indoor unit)
	CMY-Y102LS-G2	201-400 (Total capacity of indoor unit)
	CMY-Y202S-G2	401-650 (Total capacity of indoor unit)
	CMY-Y302S-G2	The 1st branch of P400-P650YSKB / EP400-EP600YSLM 651 or above (Total capacity of indoor unit)
Branch pipe (Header)	CMY-Y104-G	For 4 branches
	CMY-Y108-G	For 8 branches
	CMY-Y1010-G	For 10 branches
Relay box	PAC-BH02KTY-E	Relay box should be used together with Base heater PAC-BH-EHT-E.
Base heater	PAC-BH04EHT-E	For S Module
	PAC-BH05EHT-E	For L Module
	PAC-BH06EHT-E	For XL Module

Note : Indoor unit capacities: the capacity of an indoor unit is the same as the number used for its type identification.

## >>For PURY series

Description	Model	Remarks
Twinning kit	CMY-R100VBK-A	For PURY-P400-P500YSLM
	CMY-R100VBK2	For PURY-P550-P650YSLM
	CMY-ER100VBK-A	For PURY-EP500YSLM
	CMY-R200VBK2	For PURY-P700-P800YSLM
	CMY-ER200VBK	For PURY-EP550-EP900YSLM
	CMY-R200XLVBK	For PURY-P850-900YSLM
Branch pipe (Joint)	CMY-Y102SS-G2	200 or below (Total capacity of indoor unit)
	CMY-Y102LS-G2	201-400 (Total capacity of indoor unit)
	CMY-Y202S-G2	401-650 (Total capacity of indoor unit)
Relay box	PAC-BH02KTY-E	Relay box should be used together with Base heater PAC-BH-EHT-E.
	PAC-BH04EHT-E	For S Module
	PAC-BH05EHT-E	For L Module
Base heater	PAC-BH06EHT-E	For XL Module

Note : Indoor unit capacities: the capacity of an indoor unit is the same as the number used for its type identification.

## >>For PQHY series

Description	Model	Remarks
Branch pipe (Joint)	CMY-Y102SS-G2	200 or below (Total capacity of indoor unit)
	CMY-Y102LS-G2	201-400 (Total capacity of indoor unit)
	CMY-Y202S-G2	401-650 (Total capacity of indoor unit)
Branch pipe (Header)	CMY-Y104-G	The first branch of P400-P600
	CMY-Y302S-G2	651 or above (Total capacity of indoor unit)
	CMY-Y108-G	For 4 branches
Twinning kit	CMY-Y1010-G	For 8 branches
	CMY-Y100VBK2	For 10 branches
	CMY-Y300VBK2	For PQHY-P400-P600YSHM-A

## >>For PQR series

Description	Model	Remarks
Branch pipe (Joint)	CMY-Y102SS-G2	200 or below (Total capacity of indoor unit)
	CMY-Y102LS-G2	201-400 (Total capacity of indoor unit)
	CMY-Y202S-G2	401-650 (Total capacity of indoor unit)
Twinning kit	CMY-Q100VBK	The first branch of P400-P600 For PQR-P400-P600YSHM-A



## OPTIONAL PARTS FOR CONTROL

Model	Description	Model	Description
PAC-SE41TS-E	Remote Sensor for A/J/K/M-Net Control	PAC-YT51HAA-J	External input/output adapter for AT-50B
PAC-SE55RA-E	Remote ON/OFF adaptor for Indoor Unit	PAC-YG10HA	External input/output adapter for AE-200E / AG-150A
PAC-SA88HA-EP	Remote Display Adaptor for Indoor Unit	PAC-YG50ECA	Expansion controller for AG-150A
PAC-SA89TA-EP	Timer Adaptor for remote controller	PAC-SC51KUA	Power supply unit for AG-150A / GB-50ADA-J
PAC-SC37SA-E	Output signal connector	PAC-YG81TB	Mounting attachment B type for AG-150A wall-mount installations
PAC-SC36NA-E	Input signal connector	PAC-YG83UTB	Electric box for AG-150A wall-embed installations
PAC-SF46EPA	Transmission booster	PAC-YG84UTB	Electric box for AE-200E wall-embed installations
LMAP04-E	Air conditioner interface	PAC-YG85KTB	Mounting attachment A type for AG-150A/PAC-SC51KUA wall-mount installations
PAC-YG11CDA	Electric amount count software	PAC-YG86TK	Mounting attachment for AE-200E wall-mount installations
BAC-HD150	BAC net® and M-NET adapter	PAC-YG71CBL	Black surface cover for AG-150A

## OPTIONAL EQUIPMENT FOR BC CONTROLLER

BC Controller Model	Junction pipe kit	Branch pipe
CMB-P104V-G1, GB1	CMY-R160-J1	CMY-Y102SS-G2
CMB-P105V-G1		
CMB-P106V-G1		
CMB-P108V-G1, GA1, GB1		
CMB-P1010V-G1, GA1		
CMB-P1013V-G1, GA1		
CMB-P1016V-G1, GA1, HA1, HB1		



# Installation Information

## 1. General precautions

### 1-1. Usage

- ◆The air-conditioning system described in this catalogue is designed for human comfort.
- ◆This product is not designed for preservation of food, animals, plants, precision equipment, or art objects. To prevent quality loss, do not use the product for purposes other than what it is designed for.
- ◆To reduce the risk of water leakage and electric shock, do not use the product for air-conditioning vehicles or vessels.

### 1-2. Installation environment

- ◆Do not install any unit other than the dedicated unit in a place where the voltage changes a lot, large amounts of mineral oil (e.g., cutting oil) are present, cooking oil may splash, or a large quantity of steam can be generated such as a kitchen.
- ◆Do not install the unit in acidic or alkaline environment.
- ◆Installation should not be performed in the locations exposed to chlorine or other corrosive gases. Avoid near a sewer.
- ◆To reduce the risk of fire, do not install the unit in a place where flammable gas may be leaked or inflammable material is present.
- ◆This air conditioning unit has a built-in microcomputer. Take the noise effects into consideration when deciding the installation position. Especially in a place where antenna or electronic device are installed, it is recommended that the air conditioning unit be installed away from them.
- ◆Install the unit on a solid foundation according to the local safety measures against typhoons, wind gusts, and earthquakes to prevent the unit from being damaged, toppling over, and falling.

### 1-3. Backup system

- ◆In a place where air conditioner's malfunctions may exert crucial influence, it is recommended to have two or more systems of single outdoor units with multiple indoor units.

### 1-4. Unit characteristics

- ◆Heat pump efficiency depends on outdoor temperature. In the heating mode, performance drops as the outside air temperature drops. In cold climates, performance can be poor. Warm air would continue to be trapped near the ceiling and the floor level would continue to stay cold. In this case, heat pumps require a supplemental heating system or air circulator. Before purchasing them, consult your local distributor for selecting the unit and system.
- ◆When the outdoor temperature is low and the humidity is high, the heat exchanger on the outdoor unit side tends to collect frost, which reduces its heating performance. To remove the frost, Auto-defrost function will be activated and the heating mode will temporarily stop for 3-10 minutes. Heating mode will automatically resume upon completion of defrost process.
- ◆Air conditioner with a heat pump requires time to warm up the whole room after the heating operation begins, because the system circulates warm air in order to warm up the whole room.
- ◆The sound levels were obtained in an anechoic room. The sound levels during actual operation are usually higher than the simulated values due to ambient noise and echoes. Refer to the section on "SOUND LEVELS" in the City Multi Data Book for the measurement location.
- ◆Depending on the operation conditions, the unit generates noise caused by valve actuation, refrigerant flow, and pressure changes even when operating normally. Please consider to avoid location where quietness is required.  
For BC controller, it is recommended to unit to be installed in places such as ceilings of corridor, restrooms and plant rooms.
- ◆The total capacity of the connected indoor units can be greater than the capacity of the outdoor unit. However,

# Maintenance Equipment

## Maintenance cycle [Note that maintenance cycle does not mean guarantee period.]

The following tables are applicable when using equipment under the conditions below.

- Normal use without frequent START/STOPS (The number of START/STOPS is assumed to be less than 6 times per hour in normal use.)
- Operating hours are assumed to be 10 hours per day/2500 hours per year.

If the following conditions are met, the equipment may not be used, or the "maintenance cycle" and "replacement intervals" may be shortened.

- When equipment is used in an environment where the temperature and humidity are high or change dramatically
- When equipment is used in an environment where the power supply fluctuations (the distortion of voltage, frequency, and waveform) are large (Only within the allowable range)
- When equipment is used in an environment where the unit may receive vibration or mechanical shock
- When equipment is used in an environment where dust, salt, toxic gases such as sulfur dioxide and hydrogen sulfide, and oil mist are present
- When equipment starts/stops frequently and operates for a long time (24-hour air conditioning operation)

Table 1. Maintenance cycle

Major components	Checking cycle	Maintenance cycle	Major components	Checking cycle	Maintenance cycle
Compressor	1 year	20,000 hours	Expansion valve	1 year	20,000 hours
Motor (Fan, Louver, drain pump)		20,000 hours	Valve (solenoid valve, four-way valve)		20,000 hours
Bearing		15,000 hours	Sensor (thermistor, presser sensor)		5 years
Electric board		25,000 hours	Drain pan		8 years
Heat exchanger		5 years			

Note1 This table shows major components. Refer to the maintenance contract for details.

Note2 This maintenance cycle shows a period in which products are expected to require no maintenance. Use this cycle for planning maintenance (budgeting the maintenance expense etc.) Checking/ Maintenance cycle may be shorter than the one on this table depending on the contents of maintenance check contract.

- Sudden unpredictable accident may occur even if check-up is performed.

## Replacement cycle of consumable components [Note that replacement cycle does not mean guarantee period.]

Table 2. Replacement cycle

Major components	Checking cycle	Replacement cycle
Long-life filter	1 year	5 years
High-performance filter		1 year
Fan belt		5,000 hours
Smoothing capacitor		10 years
Fuse		10 years
Crank case heater		8 years

Note1 This table shows major components. Refer to the maintenance contract for details.

Note2 This replacement cycle shows a period in which products are expected to require no replacements. Use this cycle for planning maintenance (budgeting expenses for replacing equipments etc.)



FM33568 / ISO 9001;2008

The Air Conditioning & Refrigeration Systems Works acquired ISO 9001 certification under Series 9000 of the International Standard Organization (ISO) based on a review of Quality management for the production of refrigeration and air conditioning equipment.

**ISO Authorization System**

The ISO 9000 series is a plant authorization system relating to quality management as stipulated by the ISO. ISO 9001 certifies quality management based on the "design, development, production, installation and auxiliary services" for products built at an authorized plant.



The Air Conditioning & Refrigeration Systems Works acquired environmental management system standard ISO 14001 certification.

The ISO 14000 series is a set of standards applying to environmental protection set by the International Standard Organization (ISO).  
Registered on March 10, 1998.

- Please refer to the installation instructions before installation or servicing of these products.
  - Doing so may cause the unit or pipes to burst, or result in explosion or fire during use, during repair, or at the time of disposal of the unit.
  - It may also be in violation of applicable laws.
  - MITSUBISHI ELECTRIC CORPORATION cannot be held responsible for malfunctions or accidents resulting from the use of the wrong type of refrigerant.
- Do not use refrigerant other than the type indicated in the manuals provided with the unit and on the nameplate.
- Under Australian law, only persons suitably licensed are permitted to install, service or repair air conditioning units.



[MitsubishiElectric.com.au](http://MitsubishiElectric.com.au)

Specifications, designs and other content appearing in this brochure are current as at the time of printing and are subject to change without notice. Diagrams are representation for illustrative purposes only.