



# Multi Split Systems



# Why Choose Mitsubishi Electric?

Whether it's consistent cooling and heating for the home or office, Mitsubishi Electric offers you state-of-the-art technology that is quiet, simple to use, reliable and above all energy efficient.

Mitsubishi Electric Inverter Multi-Split Systems fulfill the air conditioning needs of up to 8 rooms with a single outdoor unit. Perfect for apartments and two-storey homes.

## **Space Savings**

The Mitsubishi Electric Inverter Multi-Split System is designed to allow several indoor units to be connected to a single outdoor unit. This enhances exterior aesthetics by reducing the number of outdoor units required, while also providing an easy and economical way of adding indoor units at any time.

## **Flexible Choice**

Offering the ability to select up to 8 indoor units for a single outdoor unit, with the cooling capacities of outdoor units ranging from 5.2kW to 15.5kW and an array of different models to suit specific applications. You will be hard pressed to find a better match for your building dimensions and comfort requirements.

## **Quiet Control**

Comfort without the noise, based on smooth operation and innovative features such as automatic selection of low-noise mode when operation load is low. Choose a wall-mounted model to create a comfortable space where noise levels allow for soothing peace and quiet.

## **Economical Operation**

Efficient operation is achieved through cooling/heating only the desired space, reducing waste by preventing air conditioning of areas where it's not needed. Using an individual air conditioner for each required space allows for a more economical performance. Combining this concept with the latest innovative inverter technologies, we are able to offer industry-leading levels of energy-efficient operation for both heating and cooling.





# Contents

<b>Comfortable and Energy-Efficient</b>	4
<b>A Single Outdoor Unit for up to 8 Rooms</b>	5
<b>Inverter Technologies</b>	6
<b>Selection</b>	8
<b>Indoor Unit Compatibility</b>	9
<b>Indoor Unit Line-up</b>	10
FH Series	12
EF Series	13
GE Series	14
MFZ Series	15
SLZ Series	16
PLA Series	17
SEZ Series	18
PEAD Series	19
PCA Series	20
MXZ Series	21
<b>Branch Box Features</b>	22
<b>Controls</b>	23
<b>Wi-Fi</b>	24
<b>Feature Glossary</b>	26
<b>Specifications</b>	29



# Comfortable and Energy-Efficient

MXZ-6E120VAD

## An Ideal Match for Apartments

The air conditioning needs of an entire house or apartment (up to 6 rooms) can be met with one compact single-fan outdoor unit.



**Smaller MXZ with 2, 3, 4, 5 or 6 ports**  
(example of MXZ-6E120VAD system)

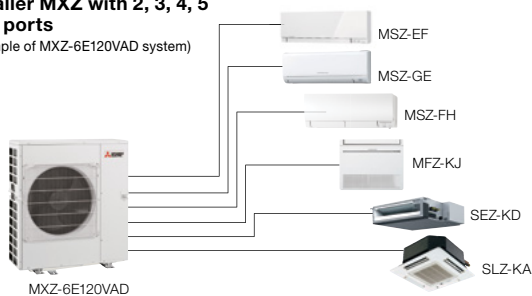

## Optimum Comfort for up to 6 Rooms with a Single Outdoor Unit

In addition to fitting into the same installation space as the MXZ-4E80VAD and MXZ-5E100VAD outdoor units, this powerful unit can manage the cooling/heating requirements of up to 6 rooms. The utilisation of a single fan has reduced constraints related to unit height as well. An improved cooling capacity of up to 13.5kW (MAX) makes it possible to accommodate diverse installation requests.

## Significant Energy Savings

Cutting-edge inverter technologies achieve an impressively high Annual Energy Efficiency Ratio (AEER) of 3.26 and Annual Coefficient of Performance (ACOP) of 3.62.



# A Single Outdoor Unit for up to 8 Rooms

MXZ-8C160VAMD

## Mitsubishi Electric's Best Solution for Two-Storey Homes

Powerful yet quiet, the new Power Multi is specially designed for use in typical Australian houses. Connecting with a 10kW indoor unit allows you to create an ideal environment on the first floor, while you can stop operation on the ground floor. Cool & heat only in the spaces that you want. Making it smarter than ever.

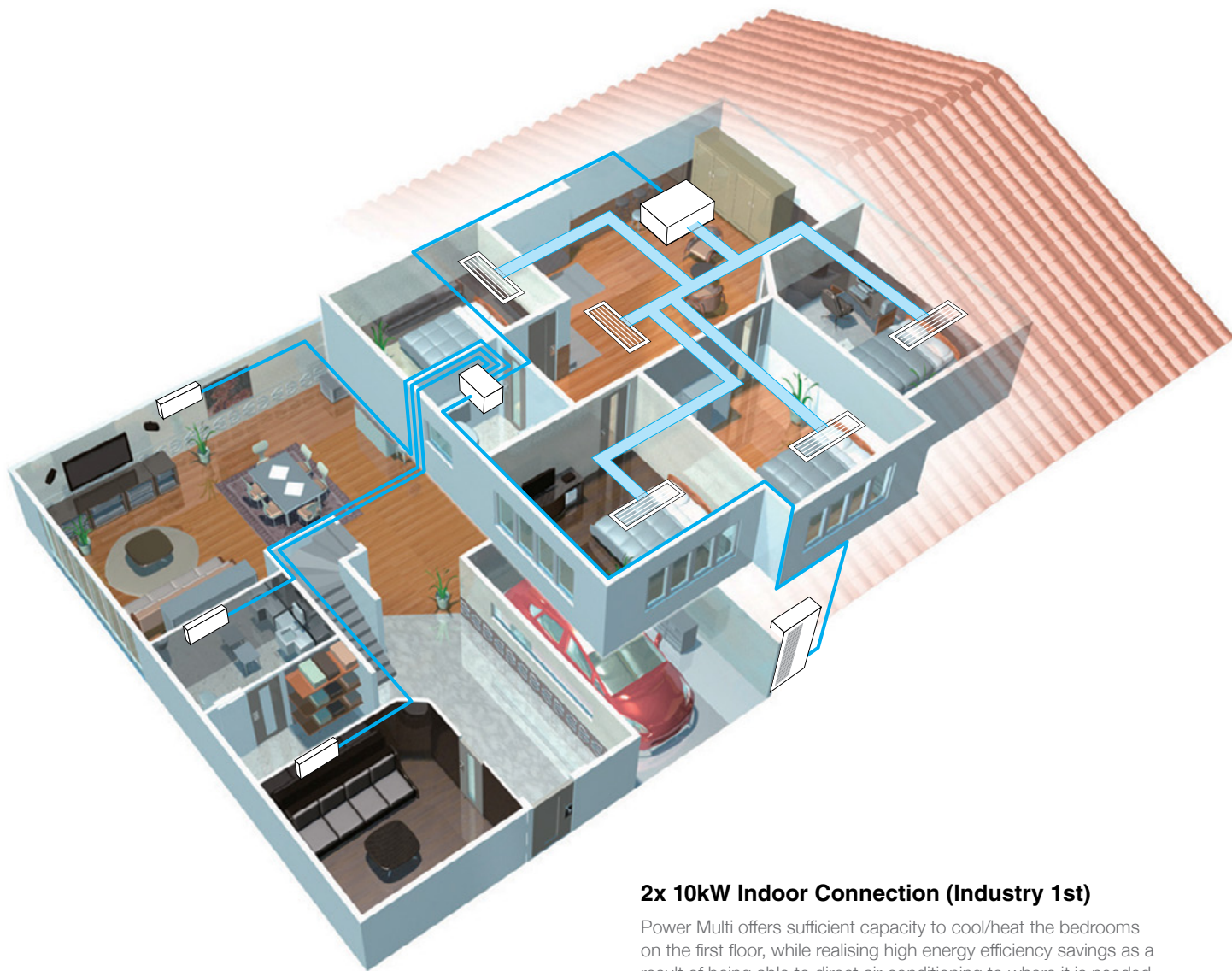

### 2x 10kW Indoor Connection (Industry 1st)

Power Multi offers sufficient capacity to cool/heat the bedrooms on the first floor, while realising high energy efficiency savings as a result of being able to direct air conditioning to where it is needed. It is the perfect solution for the comfort needs in typical Australian houses.

### High COP

The Power Multi System is equipped with Mitsubishi Electric's cutting-edge inverter technologies, achieving an impressively high Energy Efficiency Ratio (EER) of 3.32 and Coefficient of Performance (COP) of 3.90.

### Power Multi MXZ-8C160VAMD

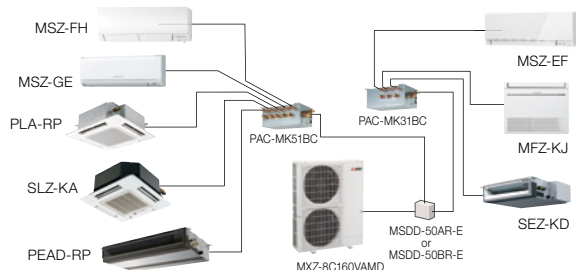

# Inverter Technologies

Mitsubishi Electric inverters ensure superior performance including the optimum control of operation frequency. As a result, optimum power is applied in all cooling/heating ranges and maximum comfort is achieved while being energy efficient.

**That's the Mitsubishi Electric promise.**

## Inverters - How do they work?

Inverters electronically control the electrical voltage, current and frequency of electrical devices such as the compressor motor in an air conditioner. They receive information from sensors monitoring operating conditions, and adjust the revolution speed of the compressor, which directly regulates air conditioner output. Optimum control of operation frequency results in energy efficiency and provides the most comfortable room environment.

## Economic Operation

Impressively low operating cost is a key advantage of inverter air conditioners. We've combined advanced inverter technologies with cutting-edge electronics and mechanical technologies to achieve a synergistic effect that enables improvements in cooling/heating performance efficiency. Better performance and energy efficiency are the result.

## True Comfort

Simple comparison of air conditioner operation control with and without an inverter.

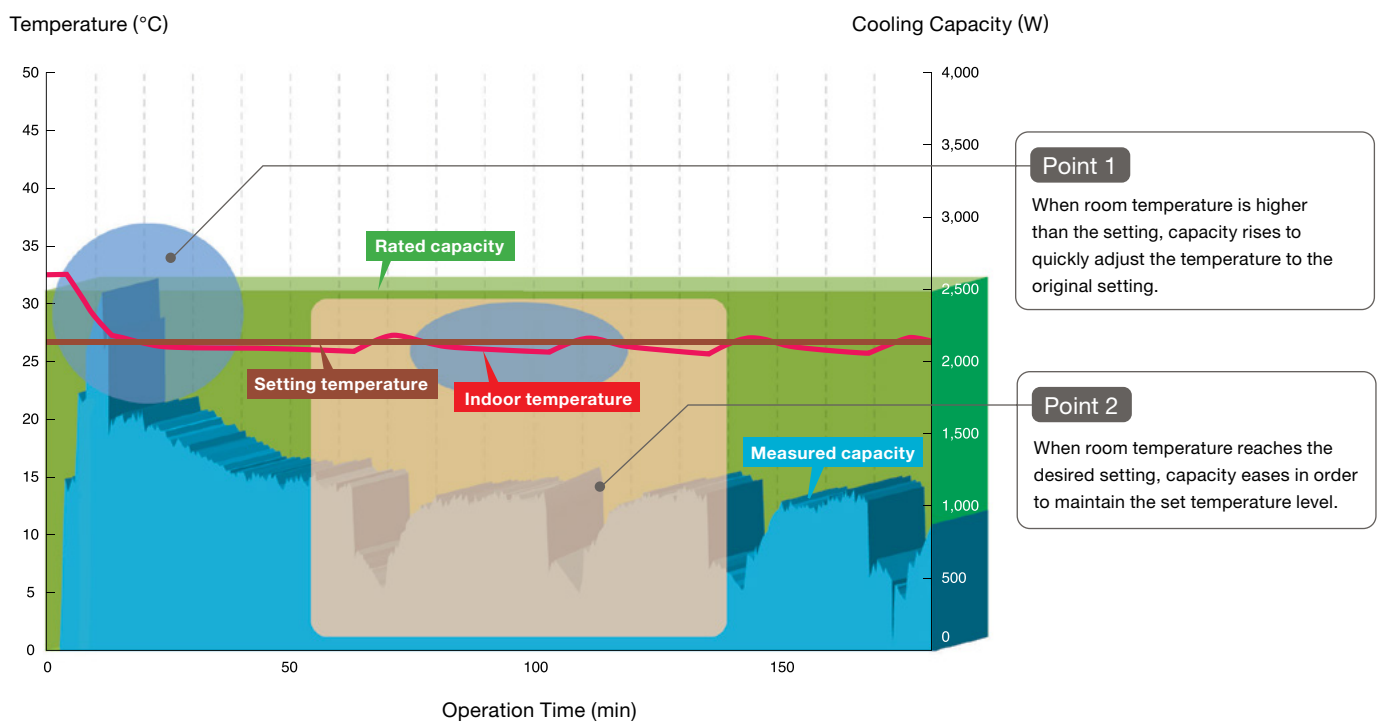

### Point 1: Quick and Powerful

Increasing the compressor motor speed by controlling the operation frequency ensures powerful output at start-up and brings the room temperature to the comfort zone faster than units not equipped with an inverter. Hot rooms are cooled, and cold rooms are heated faster and more efficiently.

### Point 2: Room Temperature Maintenance

The compressor motor operating frequency and the change of room temperature are monitored to calculate the most efficient waveform to maintain the room temperature in the comfort zone. This eliminates the large temperature swings common with non-inverter systems, and guarantees a pleasant, comfortable environment.

# MORE ADVANTAGES WITH MITSUBISHI ELECTRIC

## Reluctance DC Rotary Compressor

Powerful neodymium magnets are used in the rotor of the reluctance DC motor. More efficient operation is realised by strong magnetic and reluctance torques produced by the magnets.

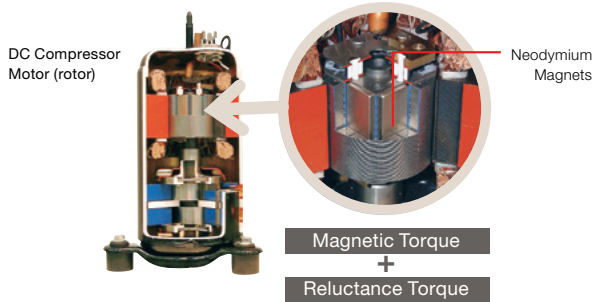

## Highly Efficient DC Scroll Compressor

Higher efficiency has been achieved by adding a frame compliance mechanism to the DC scroll compressor. The mechanism allows movement in the axial direction of the frame supporting the cradle scroll, thereby greatly reducing leakage and friction loss, and ensuring extremely high efficiency at all speeds.

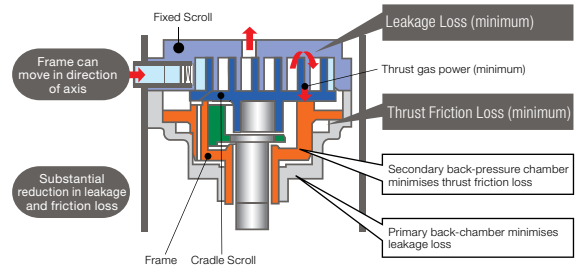

## Power Receiver and Twin LEV Control

Mitsubishi Electric has developed a power receiver and twin Linear Expansion Valves (LEV) circuit that optimise compressor performance. This technology ensures optimum control in response to operating waveform and outdoor temperature. Operating efficiency has been enhanced by tailoring the system to the characteristics of R410A refrigerant.

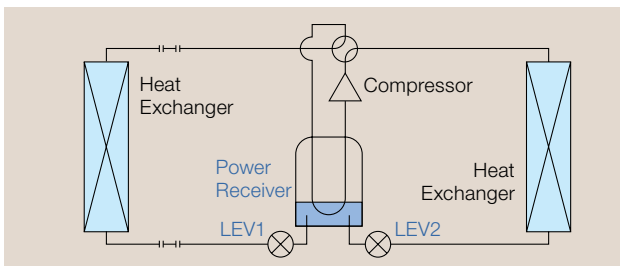

## Vector Wave ECO Inverter

This inverter monitors the varying compressor motor frequency and creates the most efficient waveform for the motor speed. As a result, operating efficiency in all speed ranges is improved, less power is used and energy consumption reduced.

### Smooth Wave Pattern

Inverter size has been reduced using insert-molding, where the circuit pattern is molded into the synthetic resin. To ensure quiet operation, soft PWM control is used to prevent the metallic whine associated with conventional inverters.

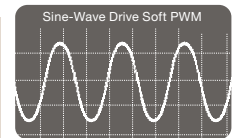

## DC Fan Motor

A highly efficient DC motor drives the fan of the outdoor unit. Efficiency is much higher than an equivalent AC motor.

## Grooved Piping

High-performance grooved piping is used in heat exchangers to increase the heat exchanging area.

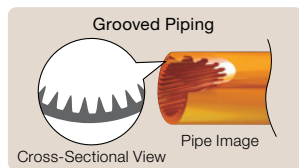







## Demand Response Capable

Based on connection of a demand response enabling device (DRED), Demand Response Mode is activated in response to signals sent from the electric power company at times when it is necessary to reduce peak demand. Based on AS/NZS 4755.3.1:2014 (Excludes MXZ-2D52VA).



# Selection

STEP 1		SELECT INDOOR UNITS		
Select the indoor unit to be installed in each room.				
Wall-mounted	Floor-standing	4-way ceiling cassette	Ceiling suspended	Ceiling concealed
 MSZ-FH  MSZ-EF  MSZ-GE	 MFZ-KJ	 SLZ-KA  PLA-RP	 PCA	 PEAD-RP  SEZ-KD

STEP 2		SELECT OUTDOOR UNITS	
2-port	2/3/4-port	8-port	
 MXZ-2D52VA	 MXZ-2E52VAD MXZ-3E54VAD MXZ-4E71VAD	 <b>Outdoor Unit</b> MXZ-8C140VAMD MXZ-8C160VAMD	
4/5-port	6-port	Branch Boxes	
 MXZ-4E80VAD MXZ-5E100VAD	 MXZ-6E120VAD	 <b>Branch Boxes</b> PAC-MK31BC PAC-MK51BC	

\* Connection to indoor units requires an appropriate branch box (distribution piping is required when connecting two branch boxes).

STEP 3		CHECK SYSTEM COMPATIBILITY	
Possible combinations depends on the outdoor unit chosen. Please check the following points.			
<b>CHECK INDOOR UNITS</b> Refer to the Indoor Unit Compatibility Table to check if the indoor units selected can be used with the outdoor unit selected. (Indoor units not listed in the table cannot be used.)		<b>CHECK INDOOR UNITS CAPACITY COMBINATION</b> Refer to the Combination Table on the website to check if the capacity combination of the indoor unit selected is connectable. (Combinations not listed cannot be connected.)	
If the desired combination cannot be found, please change either the indoor or outdoor unit to match one of the combinations shown in the tables.			

# Indoor Unit Compatibility

## SELECT FROM A WIDE RANGE OF STYLISH INDOOR UNITS

For an attractive installation and optimum use of indoor space, choose the system that best matches your needs from 35 models of 5 types including wall-mounted, floor-standing, ceiling-concealed, 4-way ceiling-cassette and ceiling-suspended units.

Refer to the following table to check if an indoor unit can be used with an outdoor unit. Combinations not listed in the table cannot be used.

MODEL	Wall-Mounted								Floor Standing		Ceiling Concealed						Ceiling Cassette					Ceiling Suspended			
	MSZ-FH		MSZ-EF		MSZ-GE				MFZ		SEZ				PEAD		SLZ		PLA			PCA			
	25/35	50	22/25/35/42/50		22/25/35/42/50	60	71	80	25/35	50	25/25	50	60	71	71	100	25/35	50	60	71	100	50	60	71	100
MXZ-2D52VA	•			•	•				•		•						•								
MXZ-2E52VAD	•			•	•				•		•						•								
MXZ-3E54VAD	•	•		•	•				•	•	•	•					•	•					•		
MXZ-4E71VAD	•	•		•	•				•	•	•	•	•				•	•	•				•	•	
MXZ-4E80VAD	•	•		•	•	•			•	•	•	•	•	•			•	•	•	•			•	•	•
MXZ-5E100VAD	•	•		•	•	•			•	•	•	•	•	•			•	•	•	•			•	•	•
MXZ-6E120VAD	•	•		•	•	•	•		•	•	•	•	•	•			•	•	•	•			•	•	•
MXZ-8C140VAMD	•	•		•	•	•	•		•	•	•	•	•	•	•		•	•	•	•	•		•	•	•
MXZ-8C160VAMD	•	•		•	•	•	•		•	•	•	•	•	•	•		•	•	•	•	•		•	•	•

# Indoor Unit Line-Up

## MSZ-FH Series

- Quiet 20dB Noise Level (FH25)
- Plasma Duo Filter
- 3D i-See Sensor
- Quick Clean body



2.2kW	2.5kW	3.5kW	4.2kW	5.0kW	6.0kW	7.1kW	8.0kW	10.0kW
-	✓	✓	-	✓	-	-	-	-

## MSZ-EF Series

Developed to complement modern interior room décor, MSZ-EF Series air conditioners are available in three colours specially chosen to blend in naturally wherever installed. The streamlined wall-mount indoor units have contemporary clean lines, expressing sophistication and quality. Elegant, quiet and powerful, these air conditioners are the ideal answer, providing the best match scenario for interior design and maximum room comfort.

- Built-In Weekly Timer
- Appealing design matches any room décor
- Nano Platinum Filter
- Quiet 21dB Noise Level in 'Quiet Mode' (EF22/25/35)



2.2kW	2.5kW	3.5kW	4.2kW	5.0kW	6.0kW	7.1kW	8.0kW	10.0kW
✓*1	✓	✓	✓	✓	-	-	-	-

## MSZ-GE Series

- Quiet 19dB Noise Level (GE22/25/35)
- Nano Platinum Filter (GE60/71/80)
- Built-In Weekly Timer (GE60/71/80)
- Quick Clean body
- Catechin Filter (GE22-50)
- Long & Wide (GE60/71/80)



2.2kW	2.5kW	3.5kW	4.2kW	5.0kW	6.0kW	7.1kW	8.0kW	10.0kW
✓*1	✓	✓	✓	✓	✓	✓	✓	-

## MFZ-KJ Series

- Simple & Flat Design
- Nano Platinum Filter
- Built-In Weekly Timer
- Built-In Installation Capability
- Multi-Flow Vane (Optimum Air Distribution)
- Trouble-Free Installation & Maintenance



2.2kW	2.5kW	3.5kW	4.2kW	5.0kW	6.0kW	7.1kW	8.0kW	10.0kW
-	✓	✓	-	✓	-	-	-	-

\*1 For Multi Split connection only.



### SLZ Series

- Fresh-Air Intake
- Compact 2'x2' size for ceiling installation
- Unit height of only 235mm



2.2kW	2.5kW	3.5kW	4.2kW	5.0kW	6.0kW	7.1kW	8.0kW	10.0kW
-	✓	✓	-	✓	-	-	-	-

### PLA Series

- 72 Airflow Patterns
- 3D i-See Sensor (optimal corner panel)
- Fresh-Air Intake
- High/Low Ceiling Modes



2.2kW	2.5kW	3.5kW	4.2kW	5.0kW	6.0kW	7.1kW	8.0kW	10.0kW
-	-	-	-	-	✓	✓	-	✓

**INDUSTRY 1ST**  
10.0kW Indoor Connection

### SEZ Series

- Compact Design
- Three fan speeds and four static pressure levels
- Unit height of only 200mm

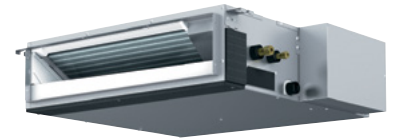

2.2kW	2.5kW	3.5kW	4.2kW	5.0kW	6.0kW	7.1kW	8.0kW	10.0kW
-	✓	✓	-	✓	✓	✓	-	-

### PEAD Series

- Compact
- 30dB Noise Level in 'Low Mode' (71)
- Lighter Weight



2.2kW	2.5kW	3.5kW	4.2kW	5.0kW	6.0kW	7.1kW	8.0kW	10.0kW
-	-	-	-	-	-	✓	-	✓

**INDUSTRY 1ST**  
10.0kW Indoor Connection

### PCA Series

- Stylish Unit Design
- Fresh-Air Intake
- 32dB Noise Level (RP50)
- High/Low Ceiling Modes



2.2kW	2.5kW	3.5kW	4.2kW	5.0kW	6.0kW	7.1kW	8.0kW	10.0kW
-	-	-	-	✓	✓	✓	-	✓

# FH Series



The FH series is the culmination of our air-cleaning, motion-sensor and airflow technologies and represent our efforts to create an air conditioner that puts healthy living as the number 1 priority.

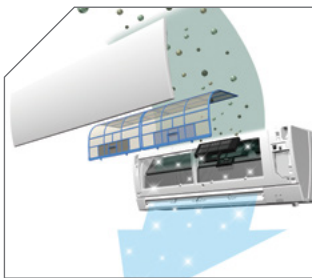

### Plasma Filter

The Plasma Filter System is an advanced, multi-stage filtration system designed to effectively neutralise contaminants such as allergens, viruses and bacteria ensuring the circulation of fresh, clean air back into the room.

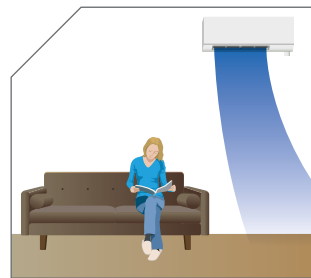

### Indirect / Direct Airflow

The indirect airflow setting can be used when the flow of air feels too strong or direct. For example, it can be used during cooling to avert airflow and prevent body temperature from becoming excessively cooled.

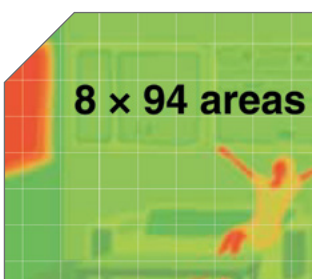

### 3D i-See Sensor

The FH Series is equipped with 3D i-See Sensor, an infrared-ray sensor that measures the temperature at distant positions. While moving to the left and right, eight vertically arranged sensor elements analyse the room temperature in three dimensions.

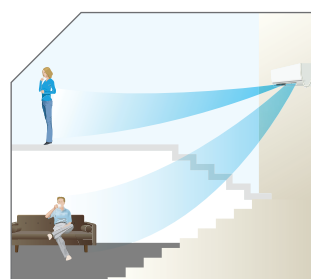

### Dual Split Vane Technology

The unique dual split vane design allows airflow to be customised to suit different areas of the room by independently directing air upwards, downwards or to the side.

## FH SERIES FEATURES

- » Heating & Cooling
- » Inverter Technology
- » Absence Detection
- » Econo Cool
- » Auto Vane
- » Anti-Mould Filter
- » Pure White
- » Compact
- » 24 Hour Timer
- » Auto Restart
- » Quick Clean
- » Weekly Timer
- » Guaranteed Operating Range  
Cooling at -10°C ~ 46°C  
Heating at -15°C ~ 24°C
- » Vertical & Horizontal Swing
- » Auto Change Over
- » 3D i-See Sensor
- » Direct/Indirect Airflow
- » Natural Flow

# EF Series



The streamlined wall-mounted indoor units have contemporary clean lines, expressing sophistication and quality. Available in 3 stylish colours classic white, matte silver and glossy black to provide the best match scenario for diverse interior designs while simultaneously ensuring maximum room and energy savings.



## Stylish Design

Developed to complement modern interior room decor, MSZ-EF Series is available in three colours glossy black, matte silver and classic white. Specially chosen to blend in naturally wherever installed.

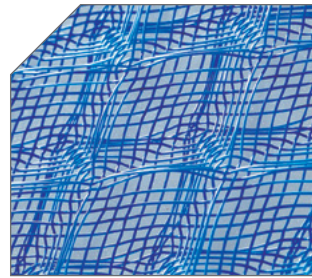

## Platinum Filter

The Nano Platinum Deodorising Filter reduces airborne bacteria while improving air quality. The optional Electro Static Anti-Allergy Enzyme Filter effectively combats common allergens.



## Quiet Comfort All Day

Mitsubishi Electric's advanced "Quiet Mode" fan speed setting provides super-quiet operation as low as 21dB for 25/35 models. This unique feature makes the MSZ-EF series ideal for use a tranquil environment.



## Wi-Fi Control

Unlock the door to smarter cooling and heating for total home comfort. You can control and monitor your air conditioner from anywhere at anytime via your smartphone, tablet or online account. Additional adapter MAC-559IF-E required per unit.

## EF SERIES FEATURES

- » Heating & Cooling
- » Inverter Technology
- » Econo Cool
- » Nano Platinum Filter
- » Auto Restart
- » 24 Hour Timer
- » Weekly Timer
- » Self Diagnosis
- » Guaranteed Operating Range  
Cooling at -10°C ~ 46°C  
Heating at -15°C ~ 24°C
- » Auto Change Over
- » Electrostatic Anti-Allergy Enzyme Filter



# GE Series



The MSZ-GE units provide excellent energy-savings and operation is impressively quiet. A vast series line-up is ready to ensure comfortable room environments in response to your air conditioning needs.



## Quiet Operation

A “Quiet Mode” setting has been added to the fan speed settings, ensuring super quiet operation below 19dB for model sizes 35 and under. Perfect for the bedroom; it’s so quiet you’ll check to see if it’s on. (Models 25/35)



## Wi-Fi Control

Unlock the door to smarter cooling and heating for total home comfort. You can control and monitor your air conditioner from anywhere at anytime via your smartphone, tablet or online account. Additional adapter MAC-559IF-E required per unit.

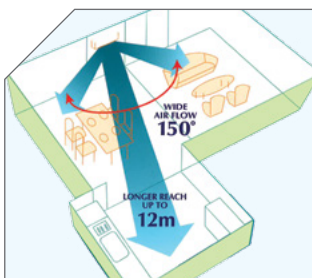

## Wide & Long Airflow

The wide and long airflow modes allow the airflow direction to be adjusted, ensuring every corner of the room is comfortable. These modes are simply activated at the touch of a button on your remote controller. The long mode extends airflow up to 12m to reach even the furthest point of large living rooms or enables kitchens to be reached in an open plan environment. (Models 60/71/80)



## i-Save mode

“i-Save” is a simplified setting function that recalls the preferred (preset) temperature by pressing a single button on the remote controller. Press the same button twice to immediately return to the previous temperature setting. Using this function contributes to energy savings when, for example, leaving the room or going to bed.

## GE SERIES FEATURES

- » Potentially Demand Response Capable
- » Econo Cool
- » Nano Platinum Filter
- » Pure White
- » Auto Vane
- » Electro Static Anti-Allergy Enzyme Filter
- » Vertical Swing
- » Horizontal Swing
- » Wide, Long & Powerful
- » Auto Change Over
- » Auto Restart
- » Only 19dB (models 22/25/35)
- » 24 Hour Timer
- » Weekly Timer 60/70/80
- » Self Diagnosis
- » Operating Temperature Cooling at -10°C~46°C Heating at -15°C~24°C

# MFZ Series

FLOOR STANDING UNIT



High capacity, simple, flat design in harmony with living spaces raises the value of your room to the next level.

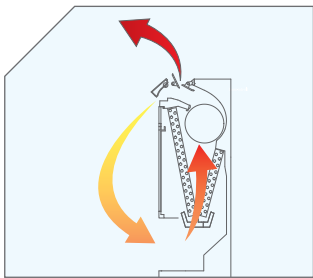

### Rapid Heating Technology

MFZ Series ensures the perfect room temperature is reached faster with Rapid Heating Technology. Warm air is blown out in a downward direction and then sucked back into the unit to quickly raise the temperature of the air being blown out.



### Slim, Sophisticated Design

Floor Consoles feature a new contemporary sleek design with linear beauty, harmonised with all types of interiors.

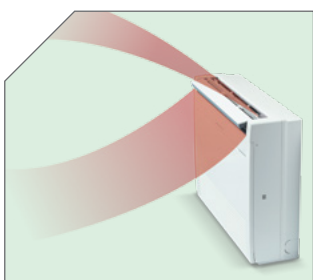

### Multi Flow Vane

A powerful blower provides optimum distribution of air from the upper and lower air outlets. The result is a comfortable environment with an even temperature throughout the room. Three uniquely shaped vanes control the airflow and allow the freedom to customise comfort according to preferences.



### Wi-Fi Control

Unlock the door to smarter cooling and heating for total home comfort. You can control and monitor your air conditioner from anywhere at anytime via your smartphone, tablet or online account. Additional adapter MAC-559IF-E required per unit.

## MFZ SERIES FEATURES

- » Heating & Cooling
- » Inverter Technology
- » Only 19dB (KJ 25/35)
- » Econo Cool
- » Nano Platinum Filter
- » Horizontal Auto Vane
- » Horizontal Swing
- » Pure White
- » Built-In Weekly Timer
- » 24 Hour Timer
- » Auto Restart
- » Guaranteed Operating Range
  - Cooling at -10°C ~ 46°C
  - Heating at -15°C ~ 24°C
- » Self Diagnosis
- » Error Logs
- » Vertical Airflow
- » Easy Installation (with leveling plate)
- » Emergency Operation Switch

# SLZ Series

## CEILING-CASSETTE



Our compact, lightweight ceiling-cassette units with 4-way airflow provide maximum comfort by evenly distributing airflow throughout the entire room.



### Air Cleaning Filter

This built-in filter removes dust and other particulates, keeping the air purified and deodorised. The long-life filter in SLZ Series air conditioners can be used for approximately 2,500 hours with simple maintenance.



### Compact Design

A design that is a perfect match for ceilings made using 2'x2' construction. The 4-way air outlet provides maximum comfort with evenly distributed airflow.

### Fresh-Air Intake

A duct hole is provided in the main body, making it possible to intake fresh air from outside.

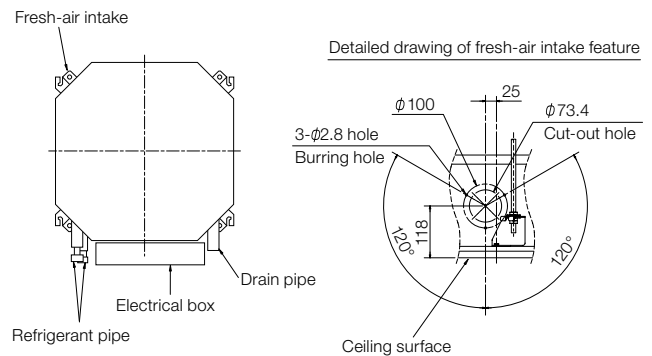

## SLZ SERIES FEATURES

- » Heating & Cooling
- » PAM Control
- » Long Life (2,500 Hour Filter)
- » Fresh Air Intake
- » Pure White
- » Auto Vane
- » Vertical Swing
- » 12 Hour Timer (SLZ-KA VAL)
- » Auto Restart
- » Weekly Timer (SLZ-KA VAQ) (PAR-33MAA-J)
- » Optional Wall Controller (SLZ-KA VAQ)
- » Guaranteed Operating Range
  - Cooling at  $-10^{\circ}\text{C} \sim 46^{\circ}\text{C}$  (KA25)
  - Cooling at  $-15^{\circ}\text{C} \sim 43^{\circ}\text{C}$  (KA50)
  - Heating at  $-15^{\circ}\text{C} \sim 24^{\circ}\text{C}$
- » Optional M-NET Connection
- » Optional Wi-Fi Control (with MAC-559IF-E)
- » Self Diagnosis (with wired R/C check code)
- » MXZ Connection
- » Error Logs



# PLA Series

## CEILING-CASSETTE



The incorporation of wide air-outlet and the "i-See Sensor" enhances airflow distribution control, achieving an enhanced level of comfort throughout the room. The synergy of higher energy efficiency and more comfortable room environment results in the utmost user satisfaction.

### *i-see* Sensor

i-See is an infrared-ray sensor that measures the temperature throughout an entire room. When connected to the air conditioner control panel, "i-see Sensor" works to maximise room comfort.

Additional adapter PAC-SA1M8-E required.

### Automatic Grille Lowering Function

An automatic grille lowering function is available for easy filter maintenance. The grille can be lowered a maximum of 4m from the ceiling in 8 steps, thus enabling easy cleaning of the air filter.

Additional adapter PLA-6BAJ required.

### Optimum Airflow

Optimum airflow settings provide maximum comfort throughout the room.

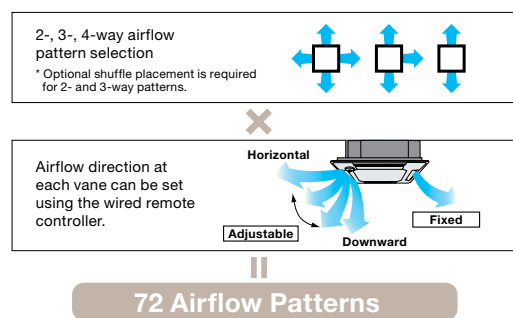

### Wide Airflow

Wide-angle outlets distribute airflow to all corners of the room.

The outlets are larger than those of previous models and the shape has been improved for better wide-angle ventilation.

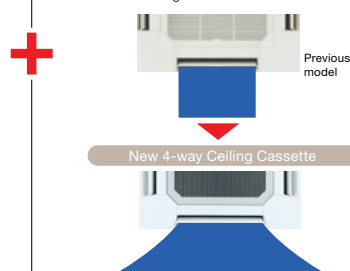
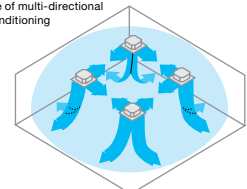

Image of multi-directional air conditioning



Individual Vane Setting + Wide Airflow

The combination of individual vane setting, which enables the optimal outlet setting for each room layout, and the wide airflow function works to ensure even temperature distribution throughout each room. The result is uniformly comfortable air conditioning.

## PLA SERIES FEATURES

- » i-See Sensor Optional
- » Pure White
- » Auto Vane
- » Long Life Filter (2,500 Hour Filter)
- » Filter Check Signal
- » Fresh-Air Intake
- » High Efficiency Filter (Optional)
- » Vertical Fin
- » Horizontal Fin
- » High Ceiling Mode
- » Low Ceiling Mode
- » Auto Fan Speed Mode
- » Self Timer
- » Auto Restart
- » Low Temp Cooling
- » Quiet Operation
- » Group Control (Optional)
- » M-NET Connection (Optional)
- » Wi-Fi Interface (Optional)
- » Cleaning Free Pipe Reuse
- » Drain Lift Up
- » Flare Connection
- » Self Diagnostic Function
- » Error Log Function

# SEZ Series

CEILING-CONCEALED



Our concealed-ceiling unit has a reduced installation space height with impressively quiet operation. Comfortable operation for the living room, bedroom and other living spaces.

## Compact Ceiling-Concealed Units

Only the intake-air grille and outlet vents are visible when using this ceiling-concealed indoor unit. The rest of the unit is conveniently hidden in the ceiling cavity, essentially leaving the ceiling and walls free of bulky looking devices and maintaining a high-class interior décor.

The compact units require minimal space and can be installed in buildings with lowered ceilings, where exposed units were the rule in the past.

### Dimension Comparison

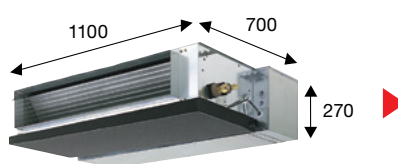

MODEL SEZ-KA35VA

Dimensions in mm

Width reduced by 110mm  
Height reduced by 70mm

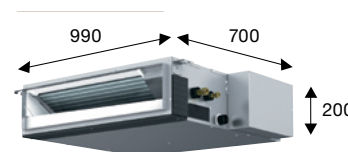

MODEL SEZ-KD35VAQ (L)

## Increased Selection of Fan Speeds and Static Pressure Levels

DC fan motor settings have been increased to accommodate more application needs. Three fan speed settings (Low, Medium and High) and four static pressure levels (5, 15, 35 and 50Pa) are now available.

Current Model	External Static Pressure
SEZ-KD25-71VA	5/15/35/50Pa
▼	
Previous Model	External Static Pressure
SEZ-KA35-71VA	30/50Pa

Four Settings Available for All Models

We've lowered the minimum Static Pressure Level, resulting in less room noise when the optimum static pressure is selected.

External Static Pressure	SPL (low fan mode)	
	SEZ-KD	SEZ-KA
15Pa	23dB	30dB
25/35 class	23dB	30dB
50 class	30dB	31dB
60 class	30dB	32dB
71 class	30dB	32dB

Maximum Noise  
Reduced by up to 7dB

## SEZ SERIES FEATURES

- » Heating & Cooling
- » Optional Wi-Fi Control (with MAC-559IF-E)
- » Weekly Timer (SEZ-VAQ) (PAR-33MAA-J)
- » Guaranteed Operating Range  
Cooling at -10°C ~ 46°C (KA25)  
Cooling at -15°C ~ 43°C (KA50)  
Cooling at -15°C ~ 46°C (KA60/71)  
Heating at -15°C ~ 24°C
- » Optional M-NET Connection
- » Flare Connection
- » Error Logs
- » Auto Restart
- » Self Diagnosis (with wired R/C check code)

# PEAD Series

CEILING-CONCEALED



For elegance and style, the PEAD Series compliments the room environment with an aesthetically pleasing ceiling installation and high-pressure static fan. Long pipe work installation is supported, increasing freedom in the placement of indoor units.

## Compact Indoor Units

The height of the current PEAD models has been unified to 250mm. Compared to the previous models, the height has been reduced by as much as 178mm, making installation possible in low ceilings with minimal clearance space.

## Wide Selection of Fan Speeds and External Static Pressure

Five-stage external static pressure conversions and three fan speed selections are available. Capable of being set to a maximum of 125Pa, units are applicable to a wide range of building types.

## Freedom in Installation

Versatile and easy installation is possible; for example, it is possible to adjust the distance between the air-intake and air-outlet vents to create the optimal airflow configuration.

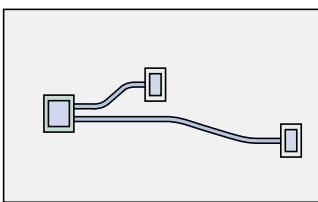

Long rectangular room

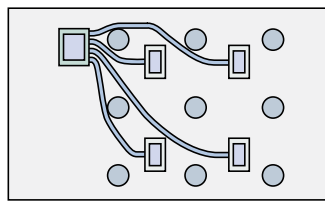

Room with fixed ceiling fixtures

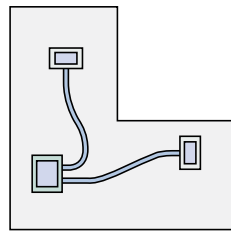

L-shaped room

## PEAD SERIES FEATURES

- » Auto Restart
- » Quiet Operation
- » Error Log Function
- » Group Control (Optional)
- » M-NET Connection (Optional)
- » Wi-Fi Interface (Optional)
- » Cleaning Free Pipe Reuse
- » Flare Connection
- » Self Diagnostic Function



# PCA Series

## CEILING-SUSPENDED



A stylish indoor unit design and airflow settings for both high and low ceiling interiors expand installation possibilities. Together with exceptional energy-saving performance, these units are the solution to diversified air conditioning needs.

### Equipped with Automatic Air-Speed Adjustment

In addition to the conventional 4-speed setting, units are now equipped with an automatic air-speed adjustment mode. This setting automatically adjusts the air-speed to conditions that match the room environment.

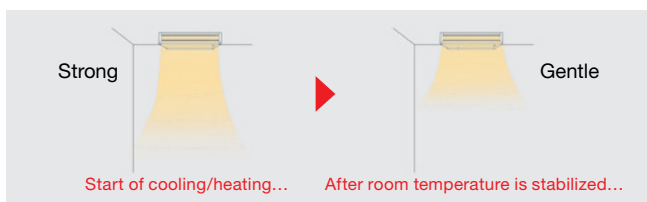

### Fresh Outside-Air Intake

Units are equipped with a knock-out hole that enables the induction of fresh outside-air.

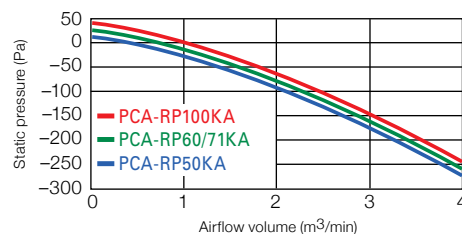

### Equipped with High and Low Ceiling Modes

Units are equipped with high and low ceiling operation modes that make it possible to switch the airflow volume to match room height

Class	High Ceiling	Standard Ceiling	Low Ceiling
50	3.5m	2.7m	2.5m
60	3.5m	2.7m	2.5m
71	3.5m	2.7m	2.5m
100	4.2m	3.0m	2.6m

## PCA SERIES FEATURES

- » Long Life Filter (2,500 Hour Filter)
- » Filter Check Signal
- » Fresh-Air Intake
- » Pure White
- » Auto Vane
- » High Efficiency Filter (Optional)
- » Vertical Fin
- » Horizontal Swing
- » High Ceiling Mode
- » Low Ceiling Mode
- » Auto Fan Speed Mode
- » Auto Restart
- » Quiet Operation
- » Group Control (Optional)
- » M-NET Connection (Optional)
- » Wi-Fi Interface (Optional)
- » Cleaning Free Pipe Reuse
- » Drain Lift Up
- » Flare Connection
- » Self Diagnostic Function
- » Error Log Function



# MXZ Series

A selection of eight MXZ outdoor units with capacities ranging between 5.2 and 15.5kW can be matched with specific M, S and P Series indoor units to handle a variety of building layouts. The best solution for multi-system air conditioning needs.



**8-Port**  
MXZ-8C140VAMD  
MXZ-8C160VAMD



**6-Port**  
MXZ-6E120VAD



**4/5-Port**  
MXZ-4E80VAD  
MXZ-5E100VAD



**2/3/4-Port**  
MXZ-2E52VAD  
MXZ-3E54VAD  
MXZ-4E71VAD



**2-Port**  
MXZ-2D52VA

## Operation Lock

To accommodate specific-use applications, cooling or heating operation can be specified when setting the control board of the outdoor unit. A convenient option when a system needs to be configured for exclusive cooling or heating service.

For detailed information about all these functions, refer to the relevant installation manual.

## Ampere Limit Adjustment

Dip switch settings can be used to adjust the maximum electrical current for operation. This function is highly recommended for managing energy costs.

For details, refer to the outdoor unit installation manual.

\* Maximum capacity is lowered with the use of this function.

## Wiring/Piping Correction Function

Simply press a single button to confirm if piping and wiring are properly connected. Wiring errors are corrected automatically when discovered. This eliminates the need to confirm complicated wiring connections when expanding the system.

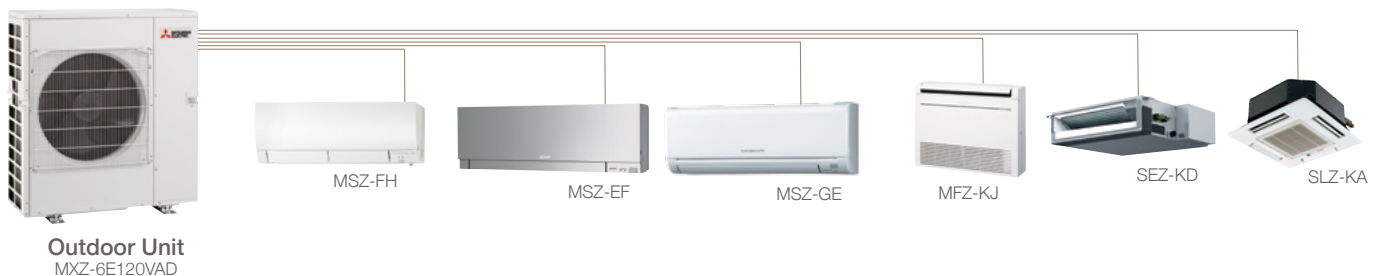
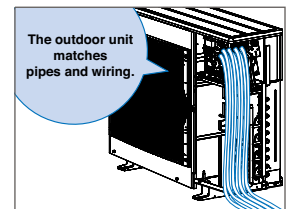
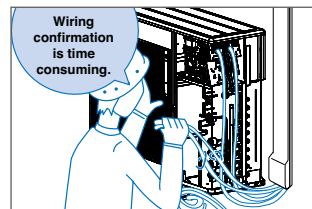

# Branch Box Features

For MXZ-8C140VAMD/MXZ-8E160VAMD



PAC-MK51BC



PAC-MK31BC

## Brazing-Free, Quick Installation

All the piping leading to and from the branch box is connected using flare joints, which are easy to use and enable pipes to be connected quickly.

## Noise Kept to a Minimum

The branch box houses a linear expansion valve (LEV), which regulates the flow of refrigerant and invariably produces noise. By locating the branch box in the ceiling or outside, noise generated by the LEV, can be kept clear of living spaces, thus maintaining the noise level to a minimum.

## Flexible Installation Indoor

The branch box can be installed in the ceiling, thus improving appearance. Maintenance is also easier through access to the circuit board and other inner parts by simply removing the controller cover.

## Flexible Installation Outdoor

The branch box can be installed outdoors by using the optional cover for outdoor installation. Eliminating the need for a special maintenance hole in the ceiling.

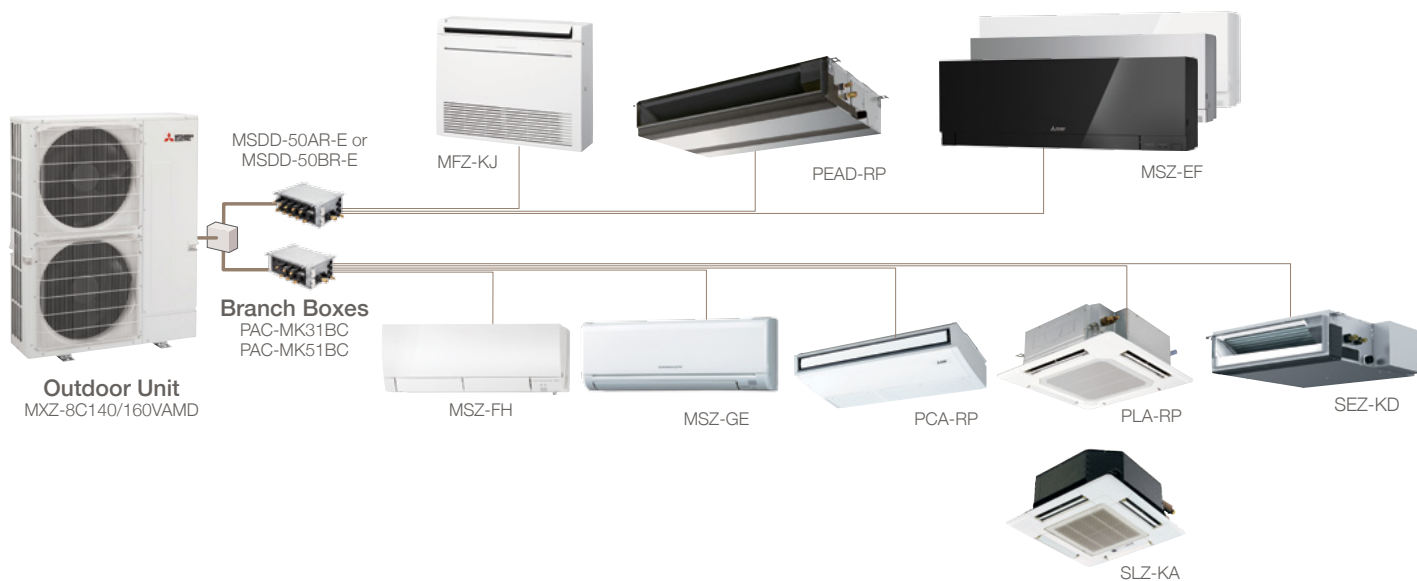

# Controls

Making the most out of your air conditioner all starts with the controls, these allow you to create the comfort levels that match your demands. As air conditioners are becoming more advanced, so are the controls, to allow accuracy and ease of use to maximise the functionality of your air conditioner. The availability of handheld remotes, wired wall controllers, internet-connectable controllers, and central based zone controllers not only provide you with a wide variety of choice, but also allow optimised programming efficiency.



## 24 Hour Controller

This simple to use remote controller features a 24 hour timer, an easy to read display and variety of operating modes at the touch of a button. An On/Off timer allows users to set operating times on a daily basis. The 'i Save' mode recalls the present temperature. This remote is standard for the GE25/35/42/50 series.



## AE-200 10.4" LCD Touch Screen

Control up to 200 units, remote monitoring via web browser or personal computer via a LAN. Featuring a large, backlit high-resolution colour touch panel, easily visible making it easy to read and control units. Fan operation time as well as energy consumption can be displayed.



## AT-50B 5" LCD Touch Screen

Simple operation at a touch with the ability to control up to 50 units. The AT-50B features both weekly and daily timer functions and night setback function. The backlit LCD lights up on touch and dims after a certain time period.



## Weekly Remote Controller

With an easy to read display and a variety of operating modes at the touch of a button. This controller features a weekly and 24 hour timer, On/Off timer to set operating times on a daily basis. The 'i-Save' mode recalls the preset temperature. This remote is standard for the GE60/71/80 Series, EF Series and FH Series.



## PAR-33MAA-J 7 Day Controller

The wall mounted 7 day controller is an optional upgrade with the ability to connect to all Mitsubishi Electric systems listed in this brochure. The PAR-33MAA-J allows you to program up to 8 stop/start patterns per day for up to 7 days at a time. Other features include a variety of operation control functions, error information, temperature range restriction, operation lock and multi-language display. The PAR-33 also offers the following at the touch of a button: LCD backlit screen, large, easy to read display and mode view for both icon and word display.

# Wi-Fi Control

Wi-Fi Control unlocks the door to smarter heating or cooling, for total home comfort wherever you are.

This innovative technology connects your domestic high wall, floor mounted and ducted air conditioner to your smartphone, tablet or online account, giving you the freedom to fully control each unit on-the-go via an Internet connection from anywhere in the world.

## Wi-Fi CONTROL



### Superior Customisation

This innovative technology places multiple functions of your air-conditioner at your fingertips. Turning the unit On/Off, adjusting set temperature, changing mode, fan speed and airflow direction are all possible.

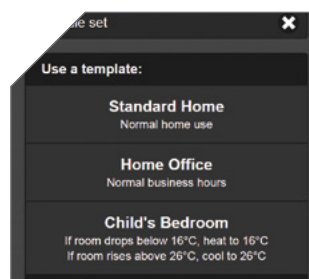

### Develop Operating Rules

Tailor your system to always meet your needs. Unlock the full potential of your air-conditioner, program your system to automatically turn On/Off at specific times, change settings, and develop temperature rules to ensure superior comfort day after day.

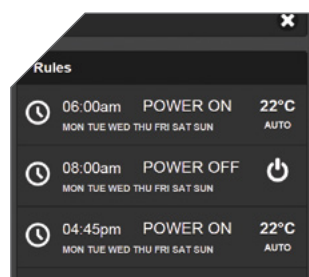

### Control Multiple Units

Customise the settings of each air-conditioner in your home. Purchase multiple adaptors to manage all air-conditioners independently on the same account to ensure complete control over your system. The result is a tailored system to your needs.

*Optional upgrade adapter required*

### Wi-Fi FEATURES

- » View & control from anywhere in the world
- » Enhance energy savings
- » Set up 7 day weekly schedule
- » Wireless connection using WPS





# FEATURE GLOSSARY

## Energy Efficiency

### 3D i-see Sensor

The FH Series is equipped with 3D i-see Sensor, an infrared-ray sensor that measures the temperature at distant positions. While moving to the left and right, eight vertically arranged sensor elements analyse the room temperature in three dimensions.

This detailed analysis makes it possible to judge where people are in the room, thus allowing creation of features such as “Indirect airflow,” to avoid airflow hitting people directly, and “direct airflow” to deliver airflow to where people are.

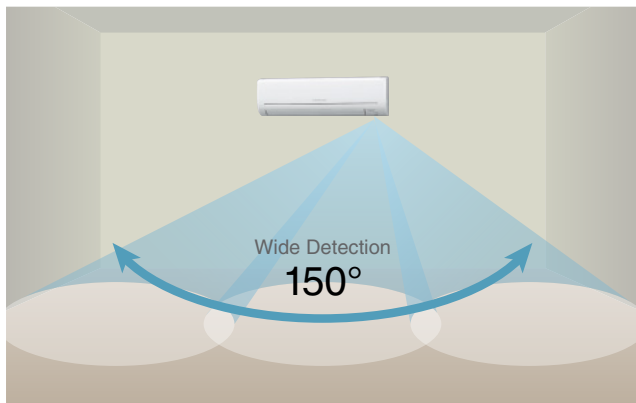

#### Indirect Airflow

The indirect airflow setting can be used when the flow of air feels too strong or direct. For example, it can be used during cooling to avert airflow and prevent body temperature from becoming excessively cooled.

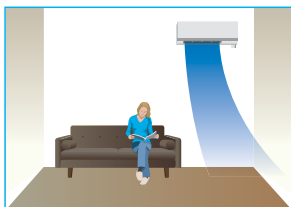

#### Indirect Airflow

This setting can be used to directly target airflow at people such as for immediate comfort when coming indoors on a hot (cold) day.

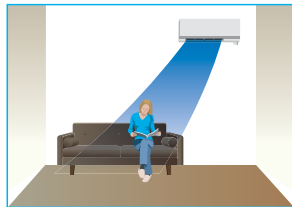

#### Absence Detection

The sensor detects whether there are people in the room. When no-one is in the room, the unit automatically switches to energy-saving mode.

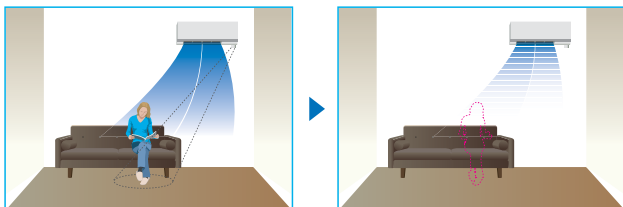

#### Demand Function (Offsite Modification)

Based on connection of a demand response enabling device (DRED), Demand Response Mode is activated in response to signals sent from the electric power company at times when it is necessary to reduce peak demand.

\*Only for MUZ-GL series, MXZ-8C140/160VAMD and MXZ-2E52/3E54/4E71/4E80/5E100/6E120VAD.

\*For MUZ-GE series and SUZ-KA series, DRED interface DRC-101A is needed.

## Econo Cool Energy Saving Feature

“Econo Cool” is an intelligent temperature control feature that adjusts the amount of air directed towards the body based on the air-outlet temperature. The setting temperature can be raised by as much as 2°C without any loss in comfort, thereby realising a gain in energy efficiency.

(Function only available during manual cooling operation).

	Conventional	Econo Cool
Ambient Temperature	35°C	35°C
Set Temperature	5°C	7°C
Perceived Temperature	30°C	29.3°C

A comfortable room environment is maintained even when setting the temperature 2°C higher than the conventional cooling mode.

#### Econo Cool On



#### Conventional Cooling Mode



Temperature distribution (°C)

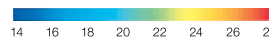

## Area Temperature Monitor

The “3D i-See Sensor” monitors the whole room in sections and directs the airflow to areas of the room where the temperature does not match the temperature setting. For example when cooling the room, if the middle of the room is detected to be hotter, more airflow is directed towards it.

This helps to prevent unnecessary cooling/heating and contributes to higher energy efficiency.

#### Cooling Mode



## Attractive

#### Pure White

Pure white is adopted for the unit colour; white expressing the essence of cleanliness and easily matching virtually all interior décor.

#### Auto Vane

The vane closes automatically when the air conditioner is not running, concealing the air outlet and creating a flat surface that is aesthetically appealing.

## Air Quality

### Plasma Duo Filter Systems

The Plasma Filter attacks bacteria and viruses from inside the unit using a strong curtain-like electrical field and discharge of electric current across the whole inlet-air opening of the unit.

### Fresh-Air Intake

Indoor air quality is enhanced by the direct intake of fresh exterior air.

### Anti-Allergy Enzyme Filter

The anti-allergy enzyme filter works to trap allergens such as molds and bacteria and decompose them using enzymes retained in the filter.

### High-Efficiency Filter

The filter is charged with static electricity, enabling it to attract and capture dust particulates that regular filters don't.

### Nano Platinum Filter

The filter has a large capture area and incorporates nanometre-sized platinum- ceramic particles that work to kill bacteria and deodourise the circulating air.

### Catechin Filter

Catechin is a bioflavonoid by-product of green tea with both antiviral and antioxidant qualities. It also has an excellent deodourising effect, which is why Mitsubishi Electric uses the compound in its air conditioner filters.

In addition to improving air quality, it prevents the spreading of bacteria and viruses throughout the room. Easily removed for cleaning and maintenance, when the filter is washed regularly the deodourising action is rated to last more than 10 years.

### Long-Life Filter

A special process for the entrapment surface improves the filtering effect, making the maintenance cycle longer than that of units equipped with conventional filters.

### Filter Check Signal

Air conditioner operating time is monitored, and the user is notified when filter maintenance is necessary.

### Electro Static Anti-Allergy Enzyme Filter

This function features both the air cleaning filter and anti-allergy enzyme filter.

\*These filters are not medical devices and the care/cleaning instructions in the relevant uses manual must be followed for proper functioning.

## Air Distribution

### Horizontal Vane

The air outlet vane swings up and down so that the airflow is spread evenly throughout the room.

### Vertical Vane

The air outlet vane swings from side to side so that the airflow reaches every part of the room.

### Double Vane

Double vane separates the airflow in the different directions to deliver airflow not only across a wide area of the room, but also simultaneously to two people in different locations.

### High Ceiling Mode

In the case of rooms with high ceilings, the outlet-air volume can be increased to ensure that air is circulated all the way to the floor.

### Low Ceiling Mode

If the room has a low ceiling, the airflow volume can be reduced for less draft.

### Auto Fan Speed Mode

The airflow speed mode adjusts the fan speed of the indoor unit automatically according to the present room conditions.

### Wide & Long Airflow

The wide and long airflow function is especially beneficial for large spaces, helping to ensure that air is well circulated and reaches every corner of the room.

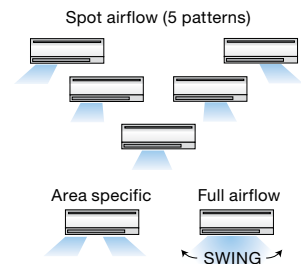
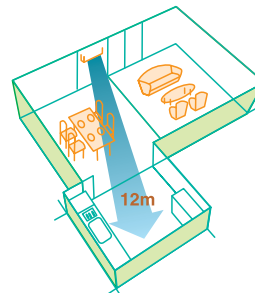

### Wide Airflow

This unique airflow system distributes air horizontally over a wide-ranging 150° in heating mode and 100° in cooling mode. Simply press the Wide Swing icon on the remote controller to select the desired airflow from seven different patterns.

### Long Airflow

Use this function to ensure that the airflow circulates to areas far across the room. Press the Long Airflow icon on the remote controller to extend reach up to as far as 12 metres from the unit.



# FEATURE GLOSSARY

## Installation

### Cleaning-Free Pipe Reuse\* (2D52/2E52/3E54/4E71/4E80/5E100/6E120)

The application of pipe reuse technology makes it possible to reuse piping, thereby allowing cleaning-free re-use of air conditioning systems that use R22 refrigerant.

\* The existing piping can not be reused if the outer diameter and the thickness of the existing piping do not meet applicable specifications or damage to piping is found.  
(2D52/2E52/3E54/4E71/4E80/5E100/6E120).

\*Cleaning-Free Pipe Reuse Technology specifically applies to piping which is contaminated with chlorine residue, iron particles and slime. These contaminants are typically found in piping in which the previous system utilised R22 refrigerant. Cleaning-Free Pipe Reuse Technology cannot be used to clean pipes which contain foreign matter other than what can be generated from an operating air conditioner.

### Wiring/Piping Correction Function

The push of a single button is all that is required to confirm that piping and wiring are properly connected. Corrections are made automatically if a wiring error is detected, eliminating the need for complicated wiring confirmation work when expanding the number of rooms served.

For details, refer to the outdoor unit installation manual.

\* This function cannot be used when the outdoor temperature is below 0°C. The correction process requires 10–20 minutes, and only works when the unit is set to the Cooling mode.

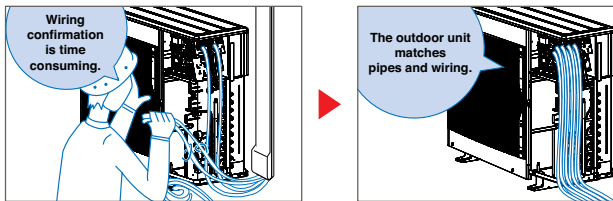

### Flare Connection

Flare connection to cooling pipe work is possible.

### Drain Pipe

A built-in drain pump enables drain piping to be raised.

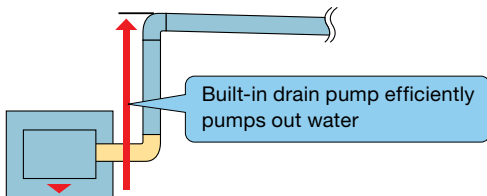

## Convenience

### On/Off Operation Timer

Use the remote controller to set the times for the air conditioner to turn on/off.

### i Save Mode

“i save” is a simplified setting function that recalls the preferred (preset) temperature by pressing a single button on the remote controller.

Press the same button twice in repetition to immediately return to the previous temperature setting. Using this function contributes to comfortable waste-free operation, realising the most suitable air conditioning settings and saving on power consumption when, for example, leaving the room or going to bed.

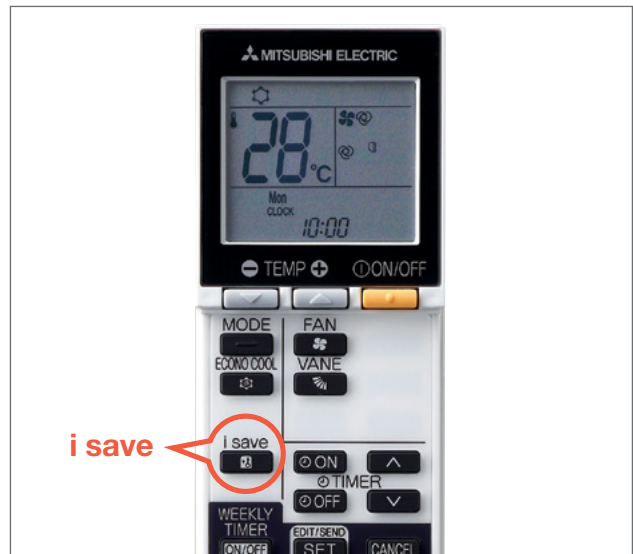

Pictured: MFZ Series remote controller

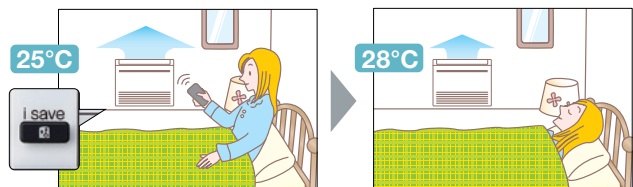

### Auto Changeover

The air conditioner automatically switches between heating and cooling modes to maintain the desired temperature.

Only Available with MXZ-8C140/140-VAMD.

### Low-temperature Cooling

Intelligent fan speed control in the outdoor unit ensures optimum performance even when the outside temperature is low.

### Auto Restart

Especially useful at the time of power outages, the unit turns back on automatically when power is restored.

### Built-in Weekly Timer Function

Easily set desired temperatures and operation on/off times to match lifestyle patterns. Reduce wasted energy consumption by using the timer to prevent forgetting to turn off the unit and eliminate temperature setting adjustments.



# OUTDOOR UNIT SPECIFICATIONS

MXZ				Up to 2 Indoor Units		Up to 3 Indoor Units	Up to 4 Indoor Units		Up to 5 Indoor Units	Up to 6 Indoor Units	
Model Name				MXZ-2D52VA	MXZ-2E52VAD	MXZ-3E54VAD-A1	MXZ-4E71VAD-A1	MXZ-4E80VAD-A1	MXZ-5E100VAD-A1	MXZ-6E120VAD-A1	
Power Supply [V, Phase, Hz, Source]				230V, Single, 50Hz, Outdoor unit power supply							
Cooling	Capacity	Rated	kW	5.2	5.2	5.4	7.1	8.0	10.0	12.0	
		Min-Max	kW	1.1 – 6.0	2.0 – 6.0	2.9 – 6.8	3.7 – 8.8	3.7 – 9.2	3.9 – 11.0	3.5 – 13.5	
	Power Input [Indoor+Outdoor]			kW	1.40	1.40	1.25	1.88	2.07	2.95	3.53
	AEER/EER [Indoor+Outdoor]				3.67 / 3.71	3.37 / 3.71	3.88 / 4.32	3.51 / 3.78	3.61 / 3.86	3.22 / 3.39	3.26 / 3.40
	Running Current [Indoor+Outdoor]			A	6.3	6.1	5.5	8.3	9.1	13.0	15.5
	Sound Pressure Level [Outdoor]			Silent - High	dB(A)	45 – 49	47 – 50	45 – 50	45 – 50	48 – 51	49 – 52
Air Volume [Outdoor]			L/s	525	633	633	633	958	1085	1050	
Heating	Capacity	Rated	kW	6.1	6.1	7.0	8.0	8.8	10.0	13.2	
		Min-Max	kW	1.0 – 7.0	1.8 – 7.2	2.6 – 9.0	3.4 – 10.7	3.4 – 11.8	4.1 – 14.0	3.5 – 16.5	
	Power Input [Indoor+Outdoor]			kW	1.59	1.59	1.61	1.84	1.91	2.30	3.49
	ACOP/COP [Indoor+Outdoor]				3.80 / 3.84	3.54 / 3.84	4.01 / 4.35	4.06 / 4.35	4.28 / 4.60	4.09 / 4.35	3.62 / 3.78
	Running Current [Indoor+Outdoor]			A	7.1	7.0	7.1	8.1	8.4	10.1	15.3
	Sound Pressure Level [Outdoor]			Silent - High	dB(A)	48 – 50	50 – 53	48 – 53	48 – 54	48 – 51	54 – 57
Air Volume [Outdoor]			L/s	532	735	735	757	927	1133	1283	
Number of Connectable Indoor Units			Min-Max	2	2	2 – 3	2 – 4	2 – 4	2 – 5	2 – 6	
Breaker Size			A	15	15	25	25	25	25	32	
Outdoor	Dimensions	Height	mm	550	710	710	710	796	796	1048	
		Width	mm	800	840	840	840	950	950	950	
		Depth	mm	285	330	330	330	330	330	330	
	Weight			kg	37	58	58	59	63	64	88
Ext. Piping	Diameter	Liquid (ø)	mm	6.35 x 2	6.35 x 2	6.35 x 3	6.35 x 4	6.35 x 4	6.35 x 5	6.35 x 6	
		Gas (ø)	mm	9.52 x 2	9.52 x 2	9.52 x 3	9.52 x 3 + 12.7 x 1	9.52 x 3 + 12.7 x 1	9.52 x 4 + 12.7 x 1	9.52 x 5 + 12.7 x 1	
	Max. Length			m	30 / 20	40 / 20	50 / 25	60 / 25	70 / 25	80 / 25	80 / 25
	Max. Height			m	15 / 10 *1	15 / 10 *1	15 / 10 *1	15 / 10 *1	15 / 10 *1	15 / 10 *1	15 / 10 *1
Refrigerant Chargeless Piping Length			m	20	40	40	40	30	5	30	
Guaranteed Operating Range (Outdoor)	Cooling			°C	-10 ~ 46	-10 ~ 46	-10 ~ 46	-10 ~ 46	-10 ~ 46	-10 ~ 46	-10 ~ 46
	Heating			°C	-15 ~ 24	-15 ~ 24	-15 ~ 24	-15 ~ 24	-15 ~ 24	-15 ~ 24	-15 ~ 24

MXZ-8C140/160VAMD				Up to 8 indoor units			
Model Name				MXZ-8C140VAMD	MXZ-8C160VAMD		
Power Supply [V, Phase, Hz, Source]				230V, Single, 50Hz, Outdoor unit power supply *4			
Cooling	Capacity	Rated	kW	14.0	15.5		
		Power Input [Outdoor]			kW	3.46	4.52
	EER *2 [Indoor+Outdoor]				3.88	3.32	
	Running Current *2 [Outdoor]			A	15.3	20.0	
	Sound Pressure Level [Outdoor]			Silent-Rated	dB(A)	47 – 50	48 – 51
	Air Volume [Outdoor]			L/s	1,833	1,833	
Heating	Capacity	Rated	kW	16.0	18.0		
		Power Input [Outdoor]			kW	3.74	4.47
	COP *2 [Indoor + Outdoor]				4.28	4.03	
	Running Current [Outdoor]			A	16.5	19.7	
	Sound Pressure Level [Outdoor]			Rated	dB(A)	52	54
	Air Volume [Outdoor]			L/s	1,833	1,883	
Number of Connectable Indoor Units			Min-Max	2 – 8	2 – 8		
Breaker Size			A	40 (32*4)	40 (32*4)		
Outdoor	Dimensions	Height	mm	1,338	1,338		
		Width	mm	1,050	1,050		
		Depth	mm	330	330		
	Weight			kg	125	125	
Ext. Piping	Diameter	Liquid (ø)	mm	9.52 x 1	9.52 x 1		
		Gas (ø)	mm	15.88 x 1	15.88 x 1		
	Max. Length			m	150 / 80	150 / 80	
	Max. Height*3			m	30 / 20	30 / 20	
Refrigerant Chargeless Piping Length			m	5 *5	5 *5		
Guaranteed Operating Range [Outdoor]	Cooling			°C	-5 ~ 46	-5 ~ 46	
	Heating			°C	-20 ~ 21	-20 ~ 21	

Type				Branch Box	
Model Name				PAC-MK51BC	PAC-MK31BC
Number of Connectable Indoor Units				Max. 5	Max. 3
Power Supply [V, Phase, Hz, Source]				230V, Single, 50Hz, Outdoor unit power supply	
Total Input			kW	0.003	
Operating Current			A	0.05	
Dimensions			mm	170x450x280	
Weight			kg	7.4	6.7
Piping	Branch [Indoor side]	Liquid	mm	6.35 x 5	6.35 x 3
		Gas	mm	9.52 x 4 + 12.7 x 1	9.52 x 3
	Main [Outdoor side]	Liquid	mm	9.52	
		Gas	mm	15.88	
Connection Method			Flared		
Wiring	To Indoor Unit			3-wire + Earth wire	
	To Outdoor Unit [Power]			2-wire + Earth wire	
	To Outdoor Unit [Comms]			2-core shielded 1.25mm <sup>2</sup> or above	

Maximum Piping Length (Total Length)							
Model	30m	40m	50m	60m	70m	80m	150m
MXZ-2D52VA	✓						
MXZ-2E52VAD		✓					
MXZ-3E54VAD			✓				
MXZ-4E71VAD				✓			
MXZ-4E80VAD					✓		
MXZ-5E100VAD						✓	
MXZ-6E120VAD							✓
MXZ-8C140VAMD							✓
MXZ-8C160VAMD							✓

## Notes:

Model name shows rated cooling capacity when max. quantity of indoor units are connected.  
 MXZ-5D100VA: 10kW at rated connected with 5 indoor units.  
 Power input, running current and AEER/ACOP are the figures when connected with below indoor units.

MXZ-2D52VA MSZ-GE35VADx2, MXZ-2E52VAD MSZ-GE35VADx2, MXZ-3E54VAD MSZ-GE25VADx3,  
 MXZ-4E71VAD MSZ-GE25VADx4, MXZ-4E80VAD MSZ-GE25VADx4, MXZ-5E100VAD MSZ-GE25VADx5,  
 MXZ-6E120VAD MSZ-GE25VADx6

## Rating Conditions:

Cooling: Indoor 27°C, D.B./19°C, W.B. Outdoor 35°C, D.B./24°C, W.B.  
 Heating: Indoor 20°C, D.B./15°C, W.B. Outdoor 7°C, D.B./6°C, W.B.

\*1 If the outdoor unit is installed higher than the indoor unit, max. Height is reduced to 10m.

\*2 Figures represented in power input, running current and EER/COP are when connected with indoor units below.

MXZ-8C140VAMD MSZ-FH25VE x 3, MSZ-FH35VE x 2,  
 MXZ-8C160VAMD MSZ-FH25VE x 2, MSZ-FH35VE x 3

\*3 The maximum height is 20m when installing an outdoor unit positioned lower than indoor unit.

\*4 Breaker Size is 32A when power is supplied separately.

\*5 Up to 15m is possible when total capacity of indoor units is within 16.0kW.

# INDOOR UNIT SPECIFICATIONS

MSZ-EF (Wall-mounted: Stylish type)										
Model Name			MSZ-EF22VE2 (W/B/S)	MSZ-EF25VE2 (W/B/S)	MSZ-EF35VE2 (W/B/S)	MSZ-EF42VE2 (W/B/S)	MSZ-EF50VE2 (W/B/S)			
Fan Speed			Quiet-Lo-Mid-Hi-SHi-Auto							
Cooling	Airflow [min-max]	ℓ/s	67 - 175	67 - 175	67 - 175	97 - 172	97 - 183			
	Sound Pressure Level [min-max]	dB	21 - 42	21 - 42	21 - 42	28 - 42	30 - 43			
Heating	Airflow [min-max]	ℓ/s	67 - 198	67 - 198	67 - 212	92 - 212	107 - 220			
	Sound Pressure Level [min-max]	dB	21 - 45	21 - 45	21 - 46	28 - 48	30 - 49			
Dimensions	Height	mm	299							
	Width	mm	895							
	Depth	mm	195							
Weight		kg	11.5							
Pipe Size [Liquid/Gas]		mm	ø6.35/ø9.52				ø6.35/ø12.7			

W: White, B: Black, S:Silver SHi ▶ Super High

MSZ-FH (Wall-mounted: Deluxe Type)										
Model Name			MSZ-FH25VE-A1			MSZ-FH35VE-A1		MSZ-FH50VE-A1		
Fan Speed			Quiet-Lo-Mid-Hi-SHi-Auto							
Cooling	Airflow [min-max]	ℓ/s	65 - 193			65 - 193		107 - 207		
	Sound Pressure Level [min-max]	dB	20 - 42			21 - 42		27 - 44		
Heating	Airflow [min-max]	ℓ/s	67 - 220			67 - 220		95 - 243		
	Sound Pressure Level [min-max]	dB	20 - 44			21 - 44		25 - 46		
Dimensions	Height	mm	305 (+17)							
	Width	mm	925							
	Depth	mm	234							
Weight		kg	13.5							
Pipe Size [Liquid/Gas]		mm	ø6.35/ø9.52				ø6.35/ø12.7			

SHi ▶ Super High

MSZ-GE (Wall-mounted: Standard Type)											
Model Name			MSZ-GE22VAD	MSZ-GE25VAD	MSZ-GE35VAD	MSZ-GE42VAD	MSZ-GE50VAD	MSZ-GE60VAD	MSZ-GE71VAD	MSZ-GE80VAD	
Fan Speed			Quiet-Lo-Mid-Hi-SHi-Auto								
Cooling	Airflow [min-max]	ℓ/s	68 - 188	68 - 188	68 - 212	97 - 213	108 - 252	163 - 305	162 - 298	162 - 298	
	Sound Pressure Level [min-max]	dB	19 - 42	19 - 42	19 - 43	26 - 46	28 - 49	29 - 49	30 - 49	30 - 49	
Heating	Airflow [min-max]	ℓ/s	68 - 192	68 - 192	68 - 192	97 - 218	108 - 242	163 - 305	170 - 298	170 - 298	
	Sound Pressure Level [min-max]	dB	19 - 42	19 - 42	19 - 43	26 - 46	28 - 48	29 - 49	30 - 49	30 - 49	
Dimensions	Height	mm	295					325			
	Width	mm	798					1,100			
	Depth	mm	232					238			
Weight		kg	10								
Pipe Size [Liquid/Gas]		mm	ø6.35/ø9.52				ø6.35/ø12.7	ø6.35/ø15.88	ø9.52/ø15.88		

SHi ▶ Super High

MFZ-KJ (Compact Floor Standing)										
Model Name			MSZ-KJ25VE			MSZ-KJ35VE		MSZ-KJ50VE		
Fan Speed			Quiet-Lo-Mid-Hi-SHi-Auto							
Cooling	Airflow [min-max]	ℓ/s	65 - 136			65 - 136		93 - 176		
	Sound Pressure Level [min-max]	dB	20 - 39			20 - 39		27 - 44		
Heating	Airflow [min-max]	ℓ/s	65 - 161			65 - 161		100 - 233		
	Sound Pressure Level [min-max]	dB	19 - 41			19 - 41		29 - 50		
Dimensions	Height	mm	600							
	Width	mm	750							
	Depth	mm	215							
Weight		kg	15							
Pipe Size [Liquid/Gas]		mm	ø6.35/ø9.52				ø6.35/ø12.7			

SHi ▶ Super High

SLZ-KA (Compact Floor Standing)										
Model Name			SLZ-KA25VAQ (L)			SLZ-KA35VAQ (L)		SLZ-KA50VAQ (L)		
Fan Speed			Lo-Mid-Hi							
Cooling	Airflow [min-max]	ℓ/s	133 - 167			133 - 183		133 - 183		
	Sound Pressure Level [min-max]	dB	28 - 37			29 - 38		30 - 39		
Heating	Airflow [min-max]	ℓ/s	133 - 167			133 - 183		133 - 183		
	Sound Pressure Level [min-max]	dB	28 - 37			29 - 38		30 - 39		
Dimensions ( ):Panel	Height	mm	235 (20)							
	Width	mm	570 (650)							
	Depth	mm	570 (650)							
Weight ( ):Panel		kg	16.5(3)							
Pipe Size [Liquid/Gas]		mm	ø6.35/ø9.52				ø6.35/ø12.7			

\*SLZ-KA VAQ: No remote controller included.

\*SLZ-KA VAL: Equipped with a wireless remote controller

PLA-RP (4-Way Cassette)					
Model Name			PLA-RP60BA	PLA-RP71BA	PLA-RP100BA
Fan Speed			Lo-Mi1-Mi2-Hi-Auto		
Cooling	Airflow [min-max]	ℓ/s	200 - 300	233 - 350	334 - 501
	Sound Pressure Level [min-max]	dB	28 - 32	28 - 34	32 - 40
Heating	Airflow [min-max]	ℓ/s	200 - 300	233 - 350	334 - 501
	Sound Pressure Level [min-max]	dB	28 - 32	28 - 34	32 - 40
Dimensions ( ):Panel	Height	mm	258 (35)		298 (35)
	Width	mm	840 (950)		
	Depth	mm	840 (950)		
Weight ( ):Panel		kg	23 (6)		25 (6)
Pipe Size [Liquid/Gas]		mm	ø6.35/ø15.88	ø9.52/ø15.88	

SEZ-KD (Compact Ceiling-Concealed)							
Model Name			SEZ-KD25VAQ (L)	SEZ-KD35VAQ (L)	SEZ-KD50VAQ (L)	SEZ-KD60VAQ (L)	SEZ-KD71VAQ (L)
Fan Speed			Lo-Mid-Hi-Auto				
Cooling	Airflow [min-max]	ℓ/s	92 - 150	117 - 183	167 - 250	200 - 300	200 - 333
	Sound Pressure Level [min-max]	dB	23 - 30	23 - 33	30 - 37	30 - 38	30 - 40
Heating	Airflow [min-max]	ℓ/s	92 - 150	117 - 183	167 - 250	200 - 300	200 - 333
	Sound Pressure Level [min-max]	dB	23 - 30	23 - 33	30 - 37	30 - 38	30 - 40
Static Pressure		Pa	5/15/35/50				
Dimensions	Height	mm	200				
	Width	mm	790	990		1,190	
	Depth	mm	700				
Weight		kg	18	21	23	27	
Pipe Size [Liquid/Gas]		mm	ø6.35/ø9.52		ø6.35/ø12.7	ø6.35/ø15.88	ø9.52/ø15.88

\*SEZ-KD VAQ: No remote controller included.

\*SEZ-KD VAL: Equipped with a wireless remote controller.

PEAD-RP (Ceiling-Concealed)				
Model Name			PEAD-RP71JAAD	PEAD-RP100JAAD
Fan Speed			Lo-Mid-Hi	
Cooling	Airflow [min-max]	ℓ/s	292 - 350 - 417	400 - 483 - 567
	Sound Pressure Level [min-max]	dB	30 - 34 - 39	33 - 38 - 42
Heating	Airflow [min-max]	ℓ/s	292 - 350 - 417	400 - 483 - 567
	Sound Pressure Level [min-max]	dB	30 - 34 - 39	33 - 38 - 42
Static Pressure		Pa	35/50/70/100/125	
Dimensions	Height	mm	250	
	Width	mm	1,100	1,400
	Depth	mm	732	
Weight		kg	30	39
Return Air Spigot Size		mm	1,058 x 210	1,358 x 210
Supply Air Spigot Size		mm	1,060 x 178	1,360 x 178
Pipe Size [Liquid/Gas]		mm	ø9.52/ø15.88	

\*No remote controller included.

Note: With PEAD Models, the total capacity of indoor units need to be 100% of the outdoor unit capacity as maximum.

PCA-RP (Ceiling Suspended)						
Model Name			PCA-RP50KAQ	PCA-RP60KAQ	PCA-RP71KAQ	PCA-RP100KAQ
Fan Speed			Lo-Mi1-Mi2-Hi-Auto			
Cooling	Airflow [min-max]	ℓ/s	167 - 250	250 - 317	267 - 333	367-467
	Sound Pressure Level [min-max]	dB	32 - 40	33 - 40	35 - 41	37-43
Heating	Airflow [min-max]	ℓ/s	167 - 250	250 - 317	267 - 333	367-467
	Sound Pressure Level [min-max]	dB	32 - 40	33 - 40	35 - 41	37-41
Dimensions	Height	mm	230			
	Width	mm	960	1,280		1,600
	Depth	mm	680			
Weight		kg	25	32		36
Pipe Size [Liquid/Gas]		mm	ø6.35/ø12.7	ø6.35/ø15.88	ø9.52/ø15.88	

\*No remote controller included.



For more information contact  
[www.mitsubishielectric.com.au](http://www.mitsubishielectric.com.au)  
Call 1300 722 228

Distributed and guaranteed throughout Australia by  
**MITSUBISHI ELECTRIC AUSTRALIA PTY. LTD.**  
(Incorporated in New South Wales) A.B.N. 58 001 215 792



Specifications, designs and other content appearing in this brochure is current at the time of printing, and is subject to change without notice. Images are representational for illustration purposes. PRINTED: JULY 2017