

# Haier

One World, One Home

## Installation and Operation Manual of Commercial Air Conditioner

This Manual applies to modular air-cooled (heat pump)  
chiller units

Modle: CA0035EAND  
CA0070EAND  
CA0130EAND

ECO  LIFE

Please read this Manual carefully before operation.  
Safekeep this Manual for future reference.

SMARTER LIFE

BETTER PLANET

## **Dear Haier users,**

Thank you for selecting and using Haier products.

Haier provides products of excellent quality and good performance. For your convenience of use, please read and follow this manual carefully. Haier's "international star-class service" is always available to you. If you have any problem during operation, please contact with us by telephone number or address on the warranty. We are always at your service.

Haier – Sincere Forever!

The Haier modular air-cooled unit you purchased may not be fully consistent with this Manual due to product improvement. We apologize for such inconvenience (if any) to you.

## **Notes to users:**

Please pay attention to the following notes for the proper use and maintenance, more efficient operation and longer service life of unit:

1. This Manual includes information necessary for the proper installation, commissioning, startup and maintenance, so please read it carefully before the startup or maintenance.
2. Installation must be performed by trained professionals.
3. For the first startup, please follow the steps herein to ensure personal and unit safety. The first startup shall be carried out under the guidance of our professional commissioning personnel or assigned personnel.

National standard applied:

GB/T 18430.1-2007

GB/T 18430.2-2007

Notes:

All figures and information herein is only for reference.

Following the principle of continuous improvement, we may update product specifications, performance, materials and structure without prior notice. Thanks for your understanding.

# Contents

Product Introduction .....	1
Safety Precautions .....	2
Controller Operation Instruction .....	3-5
<b>Installation .....</b>	<b>6</b>
Installation .....	6-13
Drawing of Overall Dimension .....	6
Unit Base Diagram .....	6-7
Pre-installation Preparation .....	8
Selection of Installation Position .....	8-10
Water Pipe Connection .....	11
Electrical Connection .....	12
Operation Inspection .....	12
Schematic Diagram of Water System.....	13
Overall Nozzle Dimensions during Module Combination .....	14
Calculations of Water System Inventory.....	15
Type Selection of Auxiliary Electric Heater.....	15
Electrical Connection .....	16-17
Connection Diagram of the Unit Power Wires .....	16
Electrical Parameters.....	16
Address Code Setting .....	17
Requirements for Communication Wires.....	17
Connection of Communication Wires .....	17
<b>Maintenance .....</b>	<b>18</b>
Maintenance .....	18
Fault Code .....	19-20
Common Faults and Troubleshooting .....	21-22
<b>Technical Data.....</b>	<b>23</b>
Performance Parameters.....	23
Unit Service Conditions .....	24
Correction Factor .....	25
<b>Warranty Declaration.....</b>	<b>26</b>

Please read this Manual carefully before use, and keep it properly.  
As for appearance, color, etc., please see actual product.

# Product Introduction

## ■ Overview

R410A-series modular air-cooled chiller unit is designed to satisfy users with the maximum reliability, safety and adaptability.

The unit is well designed with aesthetic and elegant appearance. Additionally, with adaptable configuration, the unit can be connected to various specifications and types of fan coils or air handling units.

By virtue of such advantages as high efficiency, low noise, easy and safe operation, and convenient installation and maintenance, the unit is widely applied in factories, stations,, hotels, villas, office buildings, high-end residences, etc., and also used for industrial cooling.

### ◆ High efficiency and energy saving

R410A-series modular air-cooled chiller unit adopts international advanced technology and is equipped with accessories of world-known brands and subject to full test, to ensure the reasonable matching. When running, The adoption of fully closed scroll compressor and low-noise fan makes the noise more lower; efficient scroll compressor and precise electronic expansion valve throttling system ensure the high EER and COP values, and improve the unit efficiency especially when partial loads are in operation

R410A-series modular air-cooled chiller unit can be controlled in two steps, and the modules may be combined to enable the multi-step control; for example, 16-step control is achievable when the modules of eight sets of CA0070EAND units are combined, which is almost as effective as infinitely variable control. The stepped operation of electronic control unit can reduce the impact on power grid in the startup and improve energy efficiency.

### ◆ Easy control

An electronic controller is adopted for the unit, enabling the centralized control and independent control; the controller has high anti-interference capability and can control the unit from as far as 1000 meters; the monitoring of unit operation is convenient; in case of unit fault, the controller will display corresponding fault codes.

### ◆ Convenient installation

The unit is designed to maximize the ease of installation. The cooling system has been fabricated as a closed system in factory, so no copper tube connection and refrigerant charging is required. The water system has inlet and outlet joints reserved for the connection with end equipment; upon the completion of installation as required, the system can be energized and started up after the water filling, provided that the water and the water pump pipes are clean.

The unit is reasonably structured and occupies a limited area; moreover, no specialized room is required for the installation, and the unit can be placed around a house or on balcony or roof.

### ◆ Safe operation

The cooling system is provided with high/low pressure protection to avoid too high discharging pressure and too low suction pressure; the discharging temperature protection prevents the cooling system from too high dischargingt temperature; the anti-freezing protection of the cooling system prevents the frost crack inside the plate heat exchanger under too low water temperature; besides, the anti-freezing protection of the unit avoids the frost crack of the plate heat exchanger under too low outdoor temperature when the unit stops in winter (the function is only available if the main power supply keeps on and the heating control is conducted).

### ◆ Convenient maintenance



All parts are accessible when side panel or front panel of the unit is removed, so it is convenient for maintenance and repair. In case of trip under abnormal conditions, the controller will display the fault cause to facilitate the rapid troubleshooting.

## Safety Precautions

### ■ Symbol description

◆ Dear user,

For the better understanding of this Manual and the proper operation of the chiller, the marks and symbols used in this Manual are described as follows:

	<b>WARNING:</b> it is likely to cause death, serious injury and other severe accidents if the user fails to do as required.
	<b>CAUTION:</b> it is possible for severe accident to occur

	<b>WARNING</b>
Installation and maintenance must be carried out by professionals experienced in this type of unit in accordance with applicable local codes and rules on installation and maintenance. We are not liable for any unit damage or casualty due to non-conformance with this requirement.	
The power supply must be switched off prior to maintenance and relocation of the unit; otherwise, personal injury or death may be caused by electric shock. Do not touch such hot components as compressor and exhaust pipe directly.	
When the water system contains water, control the startup and shutdown of the water pump via the water pump output point on the unit controller; otherwise, the anti-freezing protection of the unit will not work, causing the freezing crack to the heat exchanger. If the unit is to idle for a long time in winter, drain the water from the water system via the drain valve to prevent the freezing crack of the heat exchanger, the water pipe and other parts on water side. Furthermore, the water pump shall be power off to avoid starting up against frost without water.	
To prevent the heat exchanger on water side from being frozen due to foreign matters entered, a self-contained water filter must be installed on the water return pipe of the unit (specific installation position is shown in water system diagram).	
Dregs and dirt in the water pipe network including filter and heat exchanger may seriously damage the heat exchanger and water pipe. Installers and users must ensure the quality of chilled water, not use anti-icing mixtures containing salt and prevent the entry of air into the water system, because the salt and air can oxidize and corrode steel parts inside the heat exchanger.	

	<b>CAUTION</b>
No unit is allowed to be installed near such places that are dirty, oily, salty, exposed to a large amount of sulfur gas and where the unit parts may be subjected to corrosion, such as toilet vent, operation room vent and sewage treatment equipment.	
If the unit is operated below 0°C, it must be installed at a place at least 300 mm above the ground, so as to avoid icing of unit base plate and to ensure the normal operation of the unit even though the snow reaches this height; in addition, the unit shall be placed on a plane (with maximum deviation per meter of not more than 2 mm).	

# Controller Operation Instruction

## ■ Description of controller panel

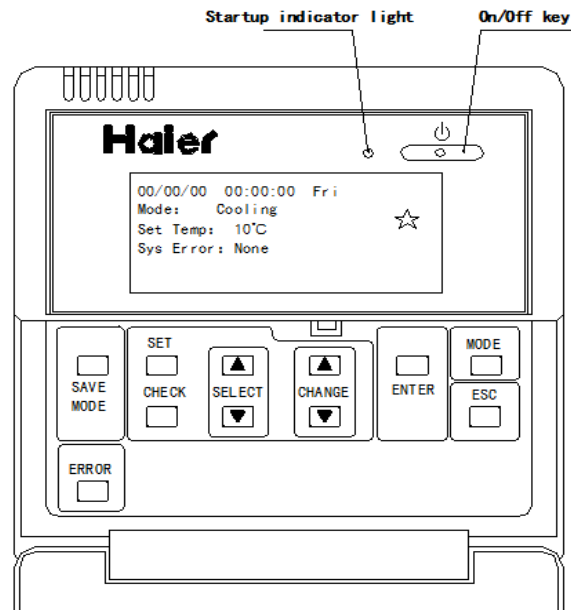

## ◆ Key description of wired controller

1. [On/Off] key: this key is used for the system on/off control; if the initial status is “off”, and the system is started up when pressing this key once, and vice versa. During the startup, the LED indicator light (green) is on.
2. [Mode] key: this key used is to change the system operation mode; once pressed this key, the operation mode is switched between cooling and heating.
3. [Power Save] key: this key is to operate the system in “Power Save” mode; if pressed this key, the target temperature of return water is set at 15°C and 37°C respectively for cooling and heating.
4. [Modify] key: this key used is used to adjust setting parameters; press ▲ or ▼ on the [Modify] key to increase or decrease setting parameters; when the wired controller is not in setting mode, this key is used to set the return water temperature and passwords.
5. [Set] key: press this key to enter the parameter setting interface; after logging into the parameter setting interface, general items (set time/timing mode/set timing) and special items can be set.
6. [Select] key: this key is used to select setting items; press ▲ or ▼ on the [Select] key to select items, and the selected character object is displayed on a black background.
7. [Ok] key: this key is used to confirm the setting items; you can press this key to select a setting item and enter the corresponding parameter setting interface.
8. [Exit] key: this key is used to exit (back); the system returns to the previous interface after each press and finally returns to the main interface of the wired controller.
9. [Query] key: this key is used to query the parameter interface of the modular unit; after logging into the parameter query interface of the modular unit, press ▲ or ▼ on the [Modify] key to select the address of the queried modular unit, and press ▲ or ▼ on the [Select] key to query the electrical performance parameters and operation conditions of the modular unit.
10. [Fault] key: this key is used to query the fault of the modular unit and log into the fault query interface.

# Controller Operation Instruction

## ◆ Description of Basic Operation of Wired Controller

1. Once powered on, the wired controller displays a startup password input interface; and the operation can be done only after the input of correct startup passwords. (please consult Haier's after sales service personnel for initial passwords).

Note: initial passwords are not set for some types of units.

2. If you want to start up the modular unit, press the [On/Off] key on the wired controller, then the system starts up and operates in the set mode, and the startup indicator light turns on.
3. The operation mode is generally selected via the [Mode] key prior to the startup, and the mode switch is allowed during the system operation; the system can automatically shut down, and then it can start up and operate in the new operation mode.
4. In the main interface, directly press the [Modify] key to change the target temperature of the return water; the modification range is 10-25°C and 25-50°C respectively for cooling and heating. The optimal set temperature is 12°C for cooling and 40°C for heating.
5. Users can operate the system in the "Power Save" mode through pressing the [Power Save] key; in the "Power Save" mode, the target temperature of return water is set at 15°C for cooling and 37°C for heating.

## ■ Description of Controller Display

- I. Upon power on, the wired controller displays the main interface first.

### Main interface

```
07/01/01 23:59:59 SUN
Set Mode: Cooling ☆
Set Temperature: 25°C [Timing]
System Fault: None
```

Date and time is displayed in the first line: MM/DD/YY hour/minute/second day of the week

Set status is displayed in the second line: Set mode; you may press the [Mode] key on the wired controller to switch the cooling/heating mode;

Linked switch status; ☆ is displayed in closed status; ☆ is not displayed in open status;

Set temperature is displayed in the third line: In heating mode, press ▲ or ▼ on the [Modify] key to set the temperature within 25°C--50°C.

In cooling mode, press ▲ or ▼ on the [Modify] key to set the temperature within 10°C—25°C.

[Timing] icon is displayed only the timing is valid on the same day.

Current fault is displayed in the fourth line: The current fault codes and the address of fault unit are displayed. If a module has several faults, the fault with a small code is reported in a priority manner; if several modules are fault, the fault with a small module address is reported in a priority manner.

- II. Press the [Set] key to enter the main item setting interface

The first three items on this interface are general items set by users, while the fourth item is a special item set by professionals.

### Main item setting interface

```
Set Time
Timing Mode:
Week/Cycle/Day/Timing Disabled
Set Timing
Set Parameter
```

### Time setting interface

```
MM 00/DD00/YY00
00 H/00M/00S
```

1. When you press the [Select] key to select the set time item, the set time is displayed on a black background; you may press the [Ok] key to enter the time setting interface.

You may press ▲ or ▼ on the [Select] key to select the modification item: Hour/Minute/Second on MM/DD/YY. The selected modification item is displayed on a black background. Press ▲ or ▼ on the [Modify] key to set corresponding values; upon the modification completion, press the [Ok] key to update and the system will return to the main interface. The timing is displayed on the main interface based on the modified time.

## Controller Operation Instruction

2. Press ▲ or ▼ on the [Select] key to select the timing mode, the selected timing mode is displayed on a black background; press ▲ or ▼ on the [Modify] key to switch among Week/Cycle/Day/Timing Disabled modes. Upon the completion of setting, press the [Exit] key to return to the previous interface, and the system completes the setting and adjustment of timing mode.
3. When you press ▲ or ▼ on the [Select] key to select the set timing item, the set timing is displayed on a black background; you may press the [Ok] key to enter the timing setting interface:
  - a. If Week Timing mode is selected, the following interface will be displayed. You may press ▲ or ▼ on the [Select] key to select Scheduled Startup/Shutdown from Monday to Sunday and over two periods a day, the selected setting is displayed on a black background, and you can press ▲ or ▼ on the [Modify] key to change the time. Upon the completion of setting, press the [Exit] key to return to the previous interface, the setting and adjustment of Week Timing mode is finished. Detailed steps are as follows:

Press ▲ or ▼ on the [Select] key to select a timing item, the setting item selected by the cursor is displayed on a black background, and then press ▲ or ▼ on the [Modify] key to set the time; the set time is increased or decreased by one minute for each press of ▲ or ▼ on the [Modify] key, until the number is 60, the time is increased or decreased by a hour; the display of "--:--" means invalid timing.

When the setting of four columns on this interface is finished, press ▲ or ▼ on the [Select] key again to enter next interface and set relevant items in the same way; and press the [Exit] key to return to previous interface after the setting completion.

Upon the setting completion, the system unit will always start up or shut down at scheduled times set in the Week Timing mode.

Note: when you press the [Modify] key for one second, the set time will continuously increase or decrease.

### Interface of Week Timing mode

Startup on Monday 1: 00 :00 Shutdown on Monday 1: 01 :00 Startup on Monday 2: 02: 00 Shutdown on Monday 2: 03 :00	Startup on Tuesday 1: --:-- Shutdown on Tuesday 1: --:-- Startup on Tuesday 2: --:-- Shutdown on Tuesday 2: --:--	-----	Startup on Sunday 1: --:-- Shutdown on Sunday 1: --:-- Startup on Sunday 2: --:-- Shutdown on Sunday 2: --:--
--	--	-------	--

- b. If the Cycle Timing mode is selected, the following interface will be displayed. When you press ▲ or ▼ on the [Select] key to select set items, the selected setting column is displayed on a black background; and then you may press ▲ or ▼ on the [Modify] key again to set the time. Upon the completion of setting, press the [Exit] key to return to the previous interface, the setting and adjustment of Cycle Timing mode is finished.

Upon the setting completion, the system unit will start up or shut down at scheduled times set in the Cycle Timing mode on daily basis.

### Interface of Cycle Timing mode

Scheduled Startup 1: --: -- Scheduled Shutdown 1: --: -- Scheduled Startup 2: --: -- Scheduled Shutdown 2: --: --
--

- c. If the Day Timing mode is selected, the following interface will be displayed. When you press ▲ or ▼ on the [Select] key to select set items, the selected setting column is displayed on a black background; and then you may press ▲ or ▼ on the [Modify] key again to set the time. Upon the completion of setting, press the [Exit] key to return to previous interface.

### Interface of Day Timing mode

After the function of the Day Timing mode is enabled, the system exits the timing function.

Scheduled Startup 1: --: -- Scheduled Shutdown 1: --: -- Scheduled Startup 2: --: -- Scheduled Shutdown 2: --: --
--

- d. If the Timing Disabled mode is selected, the system will disable the timing function, and you can not enter the timing setting interface.



# Installation

## ■ Drawing of Overall Dimension

## ■ Reference Position of Base

1. The bearing capacity of base is designed as per the weight of unit during operation.
2. The base may be of U-steel (designed by users as per overall dimensions of the unit) or concrete structure and shall have flat surface.
3. A 10-20 mm rubber shock pad shall be placed between the unit and the base.
4. The unit and the base may be fastened with  $\varnothing 16$  or  $\varnothing 18$  anchor bolts.

## ◆ Unit Base Diagram

CA0035EAND

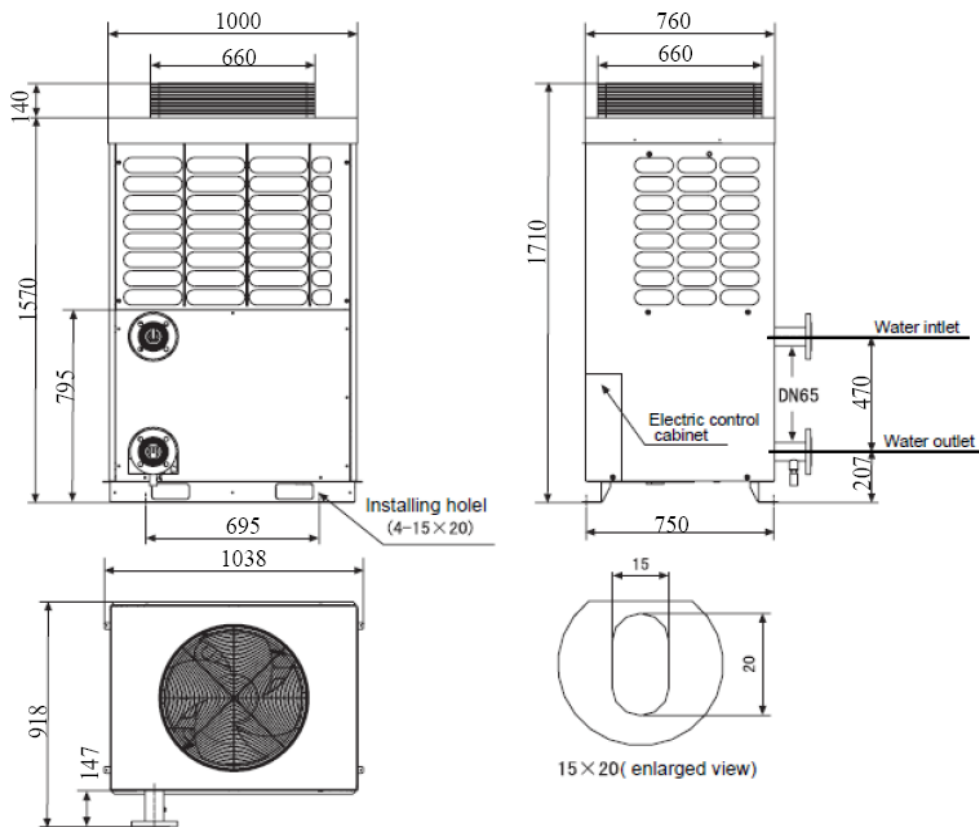

## ◆ Unit Base Diagram

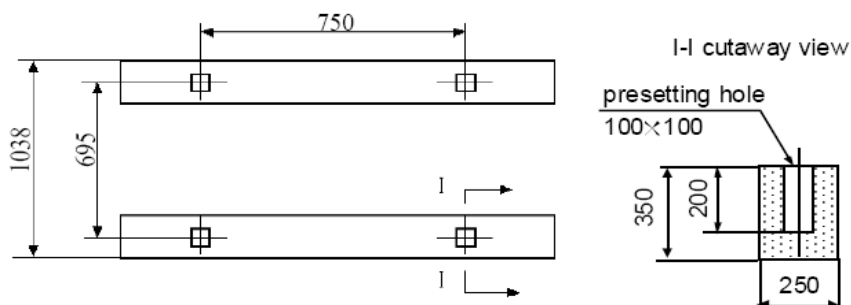

CA0070EAND

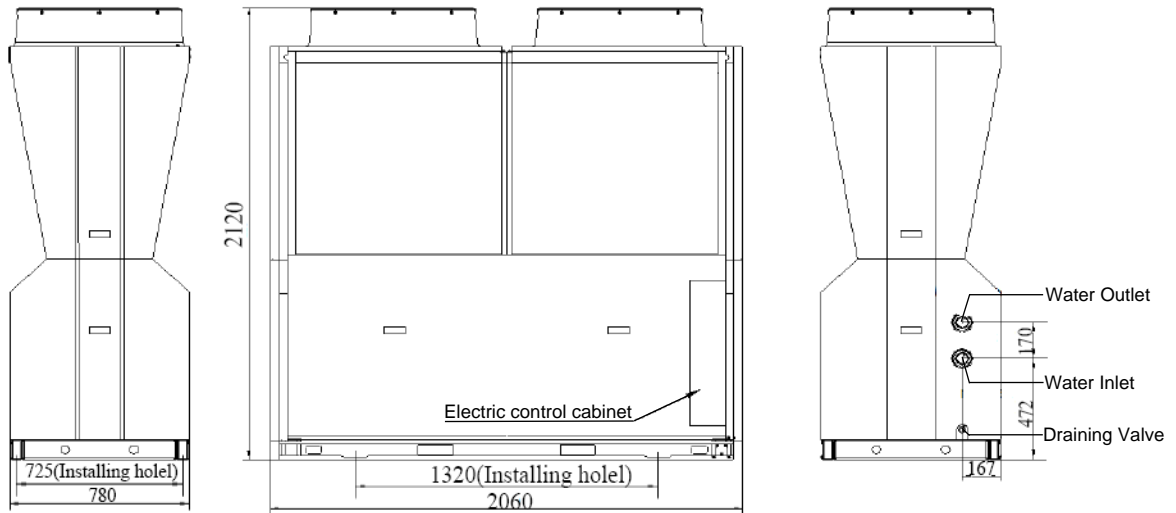

◆ Unit Base Diagram

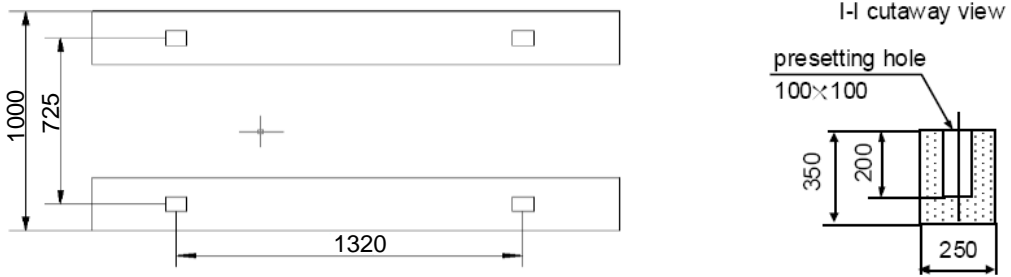

CA0130EAND

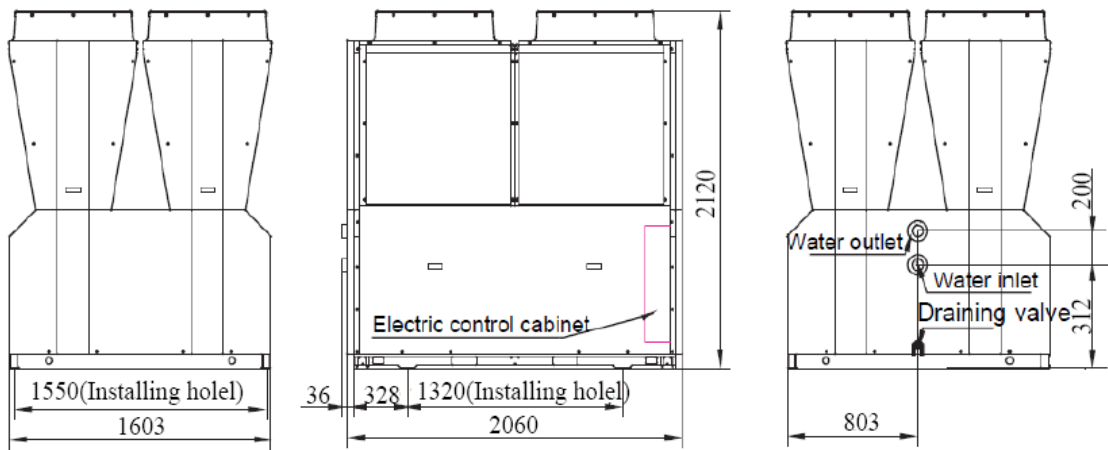

◆ Unit Base Diagram

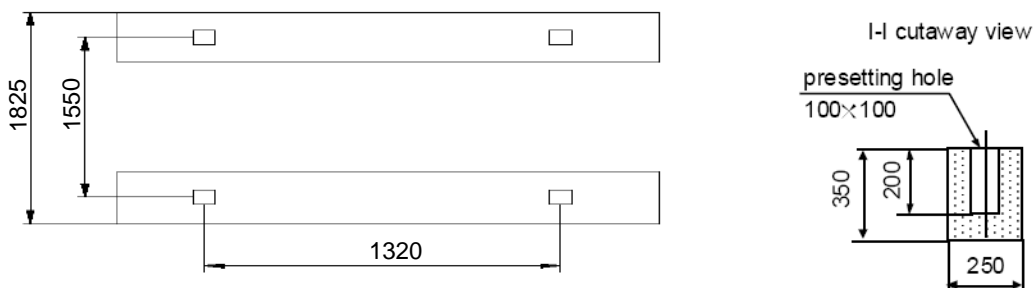

# Installation

## ■ Pre-installation Preparation

### ◆ Cargo inspection

All units are firmly bolted on wood trays, subject to ex-factory inspection and filled with accurate amount of R410a refrigerant and refrigeration oil for the unit operation. Upon the receipt, you shall carefully inspect cargoes for any damage during transport and confirm all ordered parts and accessories are delivered.

You shall inform delivery man of any damage immediately. And you shall inform problem to us other than appearance damage immediately.

### ◆ Handling

You shall handle the unit by a forklift or crane. If a crane is used, the top and side panel of the unit shall be protected by appropriate spacers (as shown in the figure). During the handling, the unit shall be kept horizontal and not be inclined for more than 30°, and the unit damage due to violations shall be avoided.

### ◆ Disassembly

Place the unit at a desired position, cut binding tapes, remove the external crate, unscrew bolts and remove the wood base from the unit bottom.

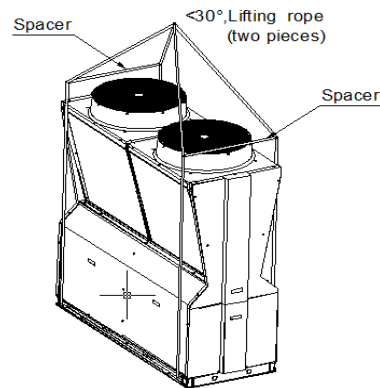

## ■ Selection Installation Position

For the better cooling (heating), the installation position of the chiller unit shall be selected as per the followings:

- ◆ The unit shall be installed at a place where the hot air exhausted by the unit is not sucked back, that exhausted by other unit is not sucked and sufficient space is reserved for the unit maintenance.
- ◆ Exhaust and suction channels of the chiller unit shall be free of any barrier that will block the air flow.
- ◆ The unit is installed at a well ventilated place to improve the heat exchange.
- ◆ The installation position shall have enough strength to withstand the unit weight and the vibration during operation.
- ◆ The unit shall not be installed at a place that is dirty, oily, salty and exposed to a large amount of sulfur gas.
- ◆ The chiller unit shall not be installed at such place where flammable gas may leak. Because the flammable gas leaked and accumulated around the unit may lead to explosion.
- ◆ The chiller unit shall not be installed at such a place exposed to strong wind or typhoon or accumulated rainwater and snow. If possible, auxiliary equipment for preventing rainwater, snow and direct sunshine may be provided.
- ◆ The unit base shall be made of concrete or support. Full consideration must be given to floor strength, drainage (water is drained from the unit during operation) and pipe and wire route in the base construction. If the base is not strong enough, the unit may fall down, causing unit damage or personal injury.
- ◆ The chiller unit shall be firmly fastened with anchor bolts to prevent falling down due to earthquake or strong wind. In order to withstand strong wind and earthquake, the unit must be positioned properly and can not be installed at such a place exposed to strong wind.
- ◆ Depending on installation conditions, vibration may be transferred to fitted parts, and base plates and walls may produce vibration and noise. Therefore, proper vibration protections (e.g. setting shock pad, dumper bracket, etc.) shall be provided.
- ◆ Edges and corners must be positioned correctly. The improper installation may lead to instability, resulting in bending of mounting feet. Any improper installation may cause the falling down of the unit, leading to personal injury.
- ◆ The unit shall be positioned so as to minimize the impact on residences; in case of special requirements for the noise, please contact us.

# Installation

1. Diagram of installation space for single chiller unit  
(Unit:mm)

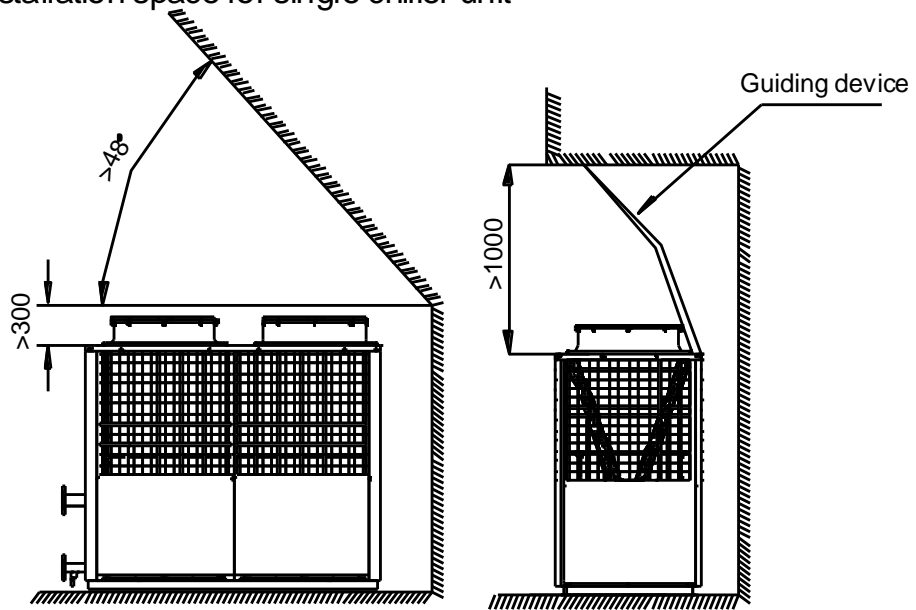

2. Diagram of installation space for multiple chiller units  
(Unit:mm)

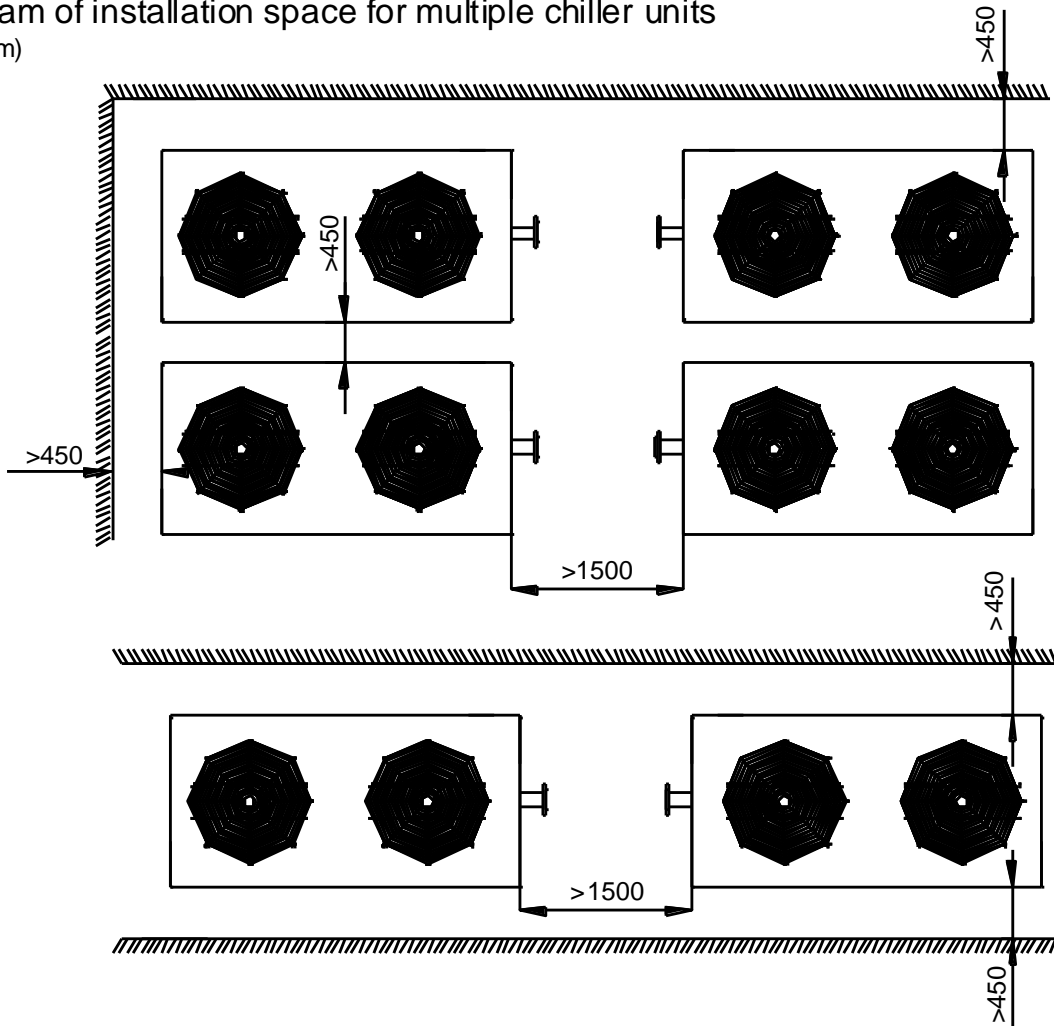



# Installation

## ■ Water Pipe Connection

1. External water pipe system must be equipped with flexible joints, water filter, electronic cleaner, check valve, drain valve, exhaust valve, shutoff valve, expansion tank, etc.. The expansion tank shall be located at 1-1.5 m above the highest point of the system; the exhaust valve shall be set between the highest point of the system and the expansion tank, and insulations shall be arranged between the tank and the pipe.
2. Water supply system must be a water pump with appropriate flow and head to ensure the normal water supply to the unit. The circulating water must be softened water.
3. A water filter must be installed in front of the inlet pipe of the unit, and the self-contained water filter also must be installed.
4. The connection between the water pump and the unit and between the water pump and the water pipe shall be realized through flexible joints; in addition, the pipe and the water pump shall be supported separately, so as to not apply any force on the unit.
5. Flushing and heating of water pipe shall be carried out prior to the connection between the pipe and the unit.
6. The drain valve on the outlet pipe is self-contained; manual or automatic exhaust valve shall be set at the highest point of the water circulation system; for the normal operation of the unit, the valve handle must be removed, so that the valve is not adjusted.
7. Water quality control  
Industrial water used as hot water is not likely to produce scale; while, well water or river water may produce a lot of scale, sand and other sediments. So, before flowing into the hot water system, the water must be filtrated and softened by water softening equipment. If sand or mud deposits in evaporator, the flow of hot water will be blocked, resulting in freezing; so relevant water values such as PH, electric conductivity, chloride ion concentration, sulfur ion concentration shall be analyzed beforehand. Quality criteria of the water for the unit are shown as follows:

Item	Criteria	Impact factor	
Standard	PH	7.5-9.0	○/□
	Electric conductivity	≤200 uv/cm(25° )	○/□
	Chloride ion	≤50 ppm	□
	Sulfate ion	≤50 ppm	□
	Total iron content	≤0.3 ppm	□
	Alkali ion	≤50 ppm	□
	Total hardness	≤50 ppm	□
Reference	Sulfur ion	N/A	□
	Ammonia ion	N/A	□
	Silicon	≤30 ppm	○

Note: ○ standing for scale, □ standing for corrosion



### WARNING

#### Never connect unclean pipe to the unit!

If the unit is to idle for a long time, the water in the water system shall be drained to prevent the plate heat exchanger being iced.

If the unit is to idle for a short time, the power-off is not allowed, because the unit has automatic anti-freezing function. When the temperature in the outlet pipe is very low, the unit will automatically operate for a period to maintain the temperature of the water system and prevent the water pipe from being frozen, so the unit must be energized in winter. If the unit is not used in winter, drain the water from the water system or fill such anti-freezing mixture as ethylene glycol and glycerol into the water system.

The water filter must be installed correctly; otherwise, the unit may be damaged. Additionally, the water filter shall be regularly inspected for any blockage due to dirt.

# Installation

## ■ SCHEMATIC DIAGRAM of WATER SYSTEM

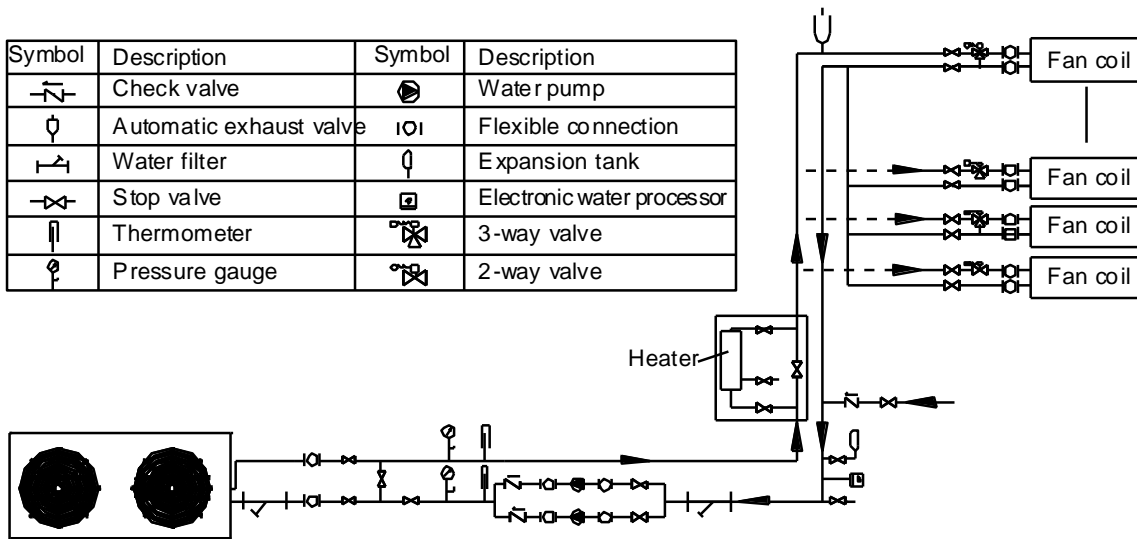

### Basic requirements

The chilled water pipelines may be connected as per relevant procedure when the unit is installed in place. Such pipelines shall be free from any foreign matter, and must conform to local piping regulations and rules.

1. Before unit operation, thoroughly flush all chilled water pipelines to ensure that they are free from any foreign matter. Note: Do not flush any foreign matter into the evaporator.
2. Water must flow into the heat exchanger via the inlet. The opposite water direction through the heat exchanger may degrade the unit performance, and give rise to fault in flow switch.
3. The water pump installed in the water pipeline system is equipped with a starter, and directly pumps water into the heat exchanger of the water system.
4. Tubing and connectors must not be mounted on the unit but independently supported.
5. The nozzles and connectors of the heat exchanger shall be easily disassembled for operation, cleaning and inspection over the evaporator nozzle.
6. The evaporator is provided with a 40-mesh filter, which must be installed at the water inlet of the unit and insulated (see the above diagram).
7. The heat exchanger ports and the site pipelines shall be flexibly connected to reduce vibration transmitted to buildings.
8. To facilitate troubleshooting, a thermometer or pressure gauge shall be installed on the water inlet and outlet pipelines. Pressure or temperature instrument are not provided with the unit and are at users' own expenses.
9. Drain ports shall be arranged at all low points of the water system to ensure that water in the evaporator and the system is completely discharged; exhaust valves shall be arranged at all high points to vent air in the pipelines. The exhaust valves and drain ports are not insulated for easy troubleshooting.
10. All water pipelines in the system exposed to frost shall be thermally insulated.
11. Outdoor chilled water pipelines shall be covered with an auxiliary heating tape and insulated with 20 mm thick thermal insulation material, so as to avoid frozen or ruptured pipelines due to low temperature. The power supply of the heating tape shall be equipped with a separate fuse.
12. Where the ambient temperature is below 0°C, or the unit is to idle for a long time, please discharge water from the unit through the water outlet pipeline connected with the plate heat exchanger of the unit. If no water discharge is required for the unit in winter, do not cut off the power supply. The fan coil in the water system must be provided with a 3-way valve to ensure that the water system is smoothly circulated after the winterizing water pump is started.

### CAUTION

The bypass pipes and stop valves of water inlet and outlet pipelines shown in the above diagram must be installed to facilitate cleaning of other systems outside of the water pipeline prior to the unit commissioning. During maintenance, the water pipelines of the heat exchanger may be cut off without interference to other heat exchangers.

# Installation

## ■ Electrical Connection

Before circuit connection, following safety rules and measures must be adhered to:

1. The unit must be installed by our service personnel or specially trained installation personnel. The installation shall be in accordance with applicable national and local laws, regulations and standards on electrical, building and environmental protection, etc., and requirements in the installation manual. Removal or addition of control components is not allowed without permission. We are not liable for any unit damage or casualty due to non-conformance with these requirements.
2. Circuits shall be connected as per "electrical connection". We provide each unit with a wiring diagram, which is located inside the control cabinet.
3. The ground wire of the unit shall be well grounded. The ground wire is not allowed to be connected to gas pipe, water pipe or telephone wire, because improper grounding may lead to electric shock.
4. Before startup, check power supply for compliance with requirements.

## ■ Operation Inspection

◆ Necessary inspection and pre**CAUTIONS** before startup

1. Confirm all electrical connections are firm.
2. Ensure the unit is installed horizontally and sufficiently supported at bottom.
3. Ensure no water seepage occurs and valves operate normally.
4. All screws necessary for panels are installed firmly and securely.
5. Confirm no refrigerant is leaked.
6. Confirm electrical and pipe connection is consistent with the scope shown on unit nameplate, wiring diagrams and other relevant documents.
7. Confirm insulations of all temperature sensors are not damaged.

◆ Inspection before operation

1. Ensure power supply is consistent with what required on unit nameplate.
2. Unit circuits are connected. Check whether power supply wire is routed and connected correctly and ground wire is firmly connected. Check interlocking devices of water pump, etc. are connected correctly.
3. Water pipes and relevant pipes. Water pipes and relevant pipes must be flushed for at least two or three times without any pollutant.
4. Check the water circulation system. Check whether water is sufficient and air is exhausted completely, and ensure there is no leakage.
5. Before initial startup or restart after shutdown over a long time, the power supply must be switched on to heat crankcase for at least 12 hours.
6. The water filter is installed as required, and there is no pollutant on the water filter screen.

◆ Inspection of operation status

When the unit operates stably, check the followings:

1. Temperature at water inlet of the unit.
2. Temperature at water outlet of the unit.
3. Outlet flow.
4. Operating current of compressor.
5. Operating current of fan.
6. High/low pressure value during cooling (heating).

You may determine whether the unit operates normally on the basis of above data.



## Installation

### ■ Overall Nozzle Dimensions during Module Combination

(Maximum 16 modules combined)

Number of modules	2	3	4	5	6	7	8	9	10	11	12	13	14	15	16
Overall nozzle dimensions (mm)	65	80	100	125	150	150	150	150	150	200	200	200	200	250	250

# Installation

## ■ Calculations of Water System Inventory



**CAUTION**

During unit operation, the actual operating capacity of the water system is less than the minimum water capacity required, resulting in frequent alarm and shutdown of the unit.

Model of unit	Preset return water temperature (°C)	Minimum effective water capacity Vmin. (l)
CA0035EAND	12	155
CA0070EAND	12	310
CA0130EAND	12	620

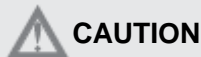

**CAUTION**

The effective water capacity of the running water system includes the total capacity of the water main, water tank, 2-way valve normally-open end which are involved in water circulation in the water system.

The actual effective water capacity (V) of the running water system must be more than or equal to Vmin., otherwise the unit may be subject to frequent alarm or shutdown!

Calculation example of water system capacity

Assume that one wr system is paterovided with two sets of CA0070EAND units, and the preset return water temperature is 12°C. The diameter of water main is DN65, and the total length of water inlet & outlet pipelines is 80m. Eight end fan coils are normally open. The internal capacity is 2L.

Calculations: Capacity of inlet & outlet water mains =  $3.14 \times \{(65/2)/1000\}^2 \times 80 \times 10^3 = 265L$

Water capacity of end fan coil =  $10 \times 2 = 20L$

The above table indicates that the required minimum capacity of the water system Vmin.=310L

To avoid frequent startup, shutdown and alarm of the unit, the capacity of water tank must be more than or equal to Vmin.=310-265-20=25L

## ■ Type Selection of Auxiliary Electric Heater

According to engineering requirements, it is recommended that one set of auxiliary electric heater be used as standby system, which is started to keep water temperature of the unit in case of defrosting or temporary fault of such equipment.

Considerations on type selection of auxiliary electric heater mainly include the minimum average outdoor ambient temperature in winter and the capacity of standby system. Based upon the local minimum average ambient temperature in winter and the water outlet temperature of the unit, the unit capacity attenuation Q2 can be obtained via comparison between the capacity Q1 from the "Performance Correction Curves" and the nominal capacity Q of the unit.

$$Q2 = Q - Q1$$

The capacity of auxiliary electric heater generally selected, W

$$W = a * Q2 = a*(Q - Q1).$$

In which, a refers to margin coefficient, taking between 1.0 and 1.5, and it is larger in northern area, e.g. taking 1.5 in Hubei province and its northern area.

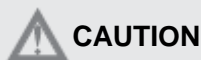

**CAUTION**

In heating mode, the unit capacity may drop with the decreasing ambient temperature, thus users shall add the auxiliary electric heater at the hot water side for the areas under the low average outdoor ambient temperature in winter, otherwise the unit performance may be affected.

# Installation

## ■ Electrical Connection

### 1. Connection diagram of the unit power cords

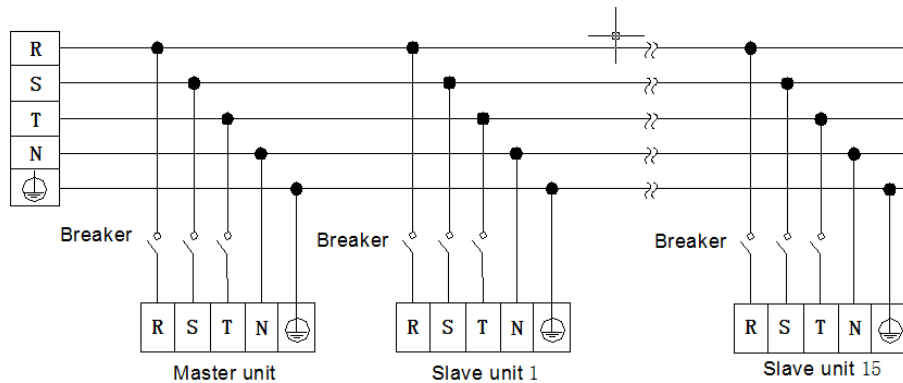

## ⚠ CAUTION

The breaker with sufficient capacity must be arranged at the entry of power cord. Such breaker shall be protected against short circuit and earth fault, and its contact spacing is at least 3mm. Please install it by yourself.

#### ◆ Control of auxiliary electric heater

The electric heater is started to provide the auxiliary heating function under the low temperature. The water inlet & outlet of the auxiliary electric heater are connected in series to the outlet water main of the modular air-cooled chiller unit, with control contacts of the auxiliary electric heater provided in the electrical cabinet of main module of the unit (only 220V output control signal provided, and the control part of electric heater equipped by users).

#### ◆ Operation control of water pump (to ensure normal operation of the unit, linkage control of the water pump and the unit must be used)

The linkage control contacts of chiller water pump are arranged in the unit control cabinet (only 220V output control signal provided, and the control part of water pump equipped by users). If the unit is in standby state, the water pump is not started; if the standby unit is switched to running state, the water pump is started firstly; if the running unit is switched to standby or shutdown state, after completion of operation, automatic shutdown of the water pump may delay.

Note: where multiple units share one set of water pipeline system, after the unit is started, all water pumps (except for standby pumps) are started, and the number of running water pumps is independent of the number of running units. Selection of water pumps shall be in accordance with requirements of units: the water flow and the nominal water flow on the nameplate shall not exceed  $\pm 30\%$ .

#### ◆ End linkage control

The passive normally-open contact (open if the end controller is disabled; and closed if it is enabled) of the end controller is connected to the linkage contact of the main module (LINE, 0V). When the unit is enabled, if at least one end controller is enabled, the unit automatically starts; if all end controllers are disabled, automatic shutdown of the unit may delay. If the unit is not provided with end linkage control, LINE, 0V shall be short-circuited.

### 2. Electrical parameters

Model of unit	Rated current	Maximum current	Locked-rotor current	Reference cable sectional area
CA0035EAND	15.8A	27.5A	155A	5X6 mm <sup>2</sup>
CA0070EAND	34.6A	55A	(155X2)A	5X10 mm <sup>2</sup>
CA0130EAND	75.4A	110A	(155X4)A	4X50 mm <sup>2</sup> +25 mm <sup>2</sup>

Note: the working voltage of the unit must be kept within  $\pm 10\%$  of the rated working voltage. If the power wiring distance is too long, the power cord diameter shall be increased under the guidance of professional electricians in accordance with the technical data provided by the cable manufacturer.

# Installation

## 3. Address Code Setting

The former four digits of the eight-digit code switch are for module address setting, and the latter four for unit mode and capacity setting. The unit mode and capacity codes have been set in delivery, and they are unchangeable. The unit address codes default to 0N, 0N, 0N and 0N (for master unit), and in delivery, the codes default to 0N, 0N, 0N and 0N.

The former four digits are available for module address:

Address No.	SW1	SW2	SW3	SW4
0	ON	ON	ON	ON
1	ON	ON	ON	OFF
2	ON	ON	OFF	ON
3	ON	ON	OFF	OFF
4	ON	OFF	ON	ON
5	ON	OFF	ON	OFF
6	ON	OFF	OFF	ON
7	ON	OFF	OFF	OFF
8	OFF	ON	ON	ON
9	OFF	ON	ON	OFF
10	OFF	ON	OFF	ON
11	OFF	ON	OFF	OFF
12	OFF	OFF	ON	ON
13	OFF	OFF	ON	OFF
14	OFF	OFF	OFF	ON
15	OFF	OFF	OFF	OFF

Note:

- (1) There is no same address code in one system.
- (2) The above address codes must be set by professionals.

## 4. Requirements for Communication Wires

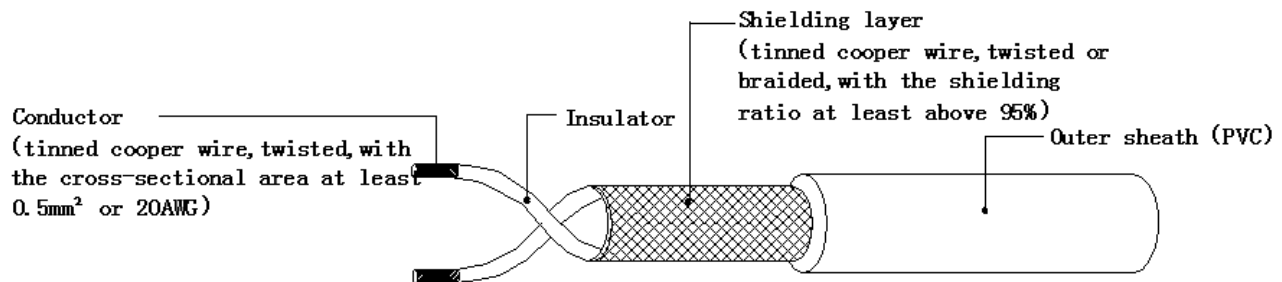

Description:

1. The network connecting wires with compact shielding layer and small lay of twisted conductors shall be selected to the greatest extent.
2. Refer to UL2547 or UL2791 wire standards.
3. The length of control wire shall not exceed 1000 m.
4. The control wire routing must be more than 200 mm away from the heavy-current installations.

## 5. Connection of Communication Wires

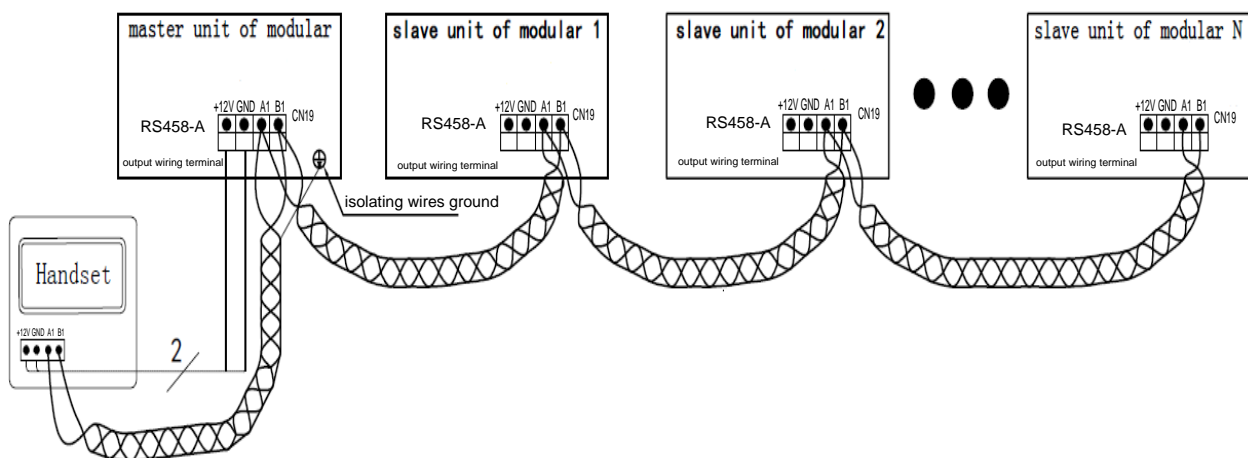

## Maintenance

### ■ Maintenance

Before delivery, the units have been strictly tested and inspected to ensure good working performance after delivery. To ensure long-term good operation of the units, users shall provide regular maintenance.

#### 1. Inspection and cleaning of condenser

To ensure effective operation of the condenser and maximize heat exchange, the appearance must be clean, and free from fallen leaves, cotton velvet, insects and other foreign matters which may result in clogged fin of the condenser.

#### 2. Inspection and cleaning of heat exchanger

To determine if the water-side heat exchanger is cleaned, please check the water inlet and outlet temperatures of the heat exchanger, and compare them with the evaporating temperature.

For example, if the difference between the water outlet temperature and the evaporating temperature exceeds 5–7°C at the rated flow, the working efficiency of the heat exchanger has been lowered, and cleaning is required.

Some chemical treatments are required during cleaning, thus such cleaning must be completed by professionals.

#### 3. Make-up of refrigerant and lube oil

Each unit in delivery has been provided with sufficient refrigerant R410A and lube oil.

The normally running system requires no make-up of refrigerant or lube oil. Charging or replacement of refrigerant or lube oil at will is also not allowed. If make-up is required due to leakage, please refer to the charge stated on the unit nameplate.

# Maintenance

## ■ Fault Code

S/N	Fault code	Fault description	Remarks
1	E01	Fault in flow switch	
2	E05	Three-phase AC input phase failure protection	
3	E06	Three-phase AC input phase sequence protection	
4	E07	Fault in return water temperature sensor	
5	E08	Fault in water outlet temperature sensor	
6	E09	Fault in outdoor ambient temperature sensor	
7	E16	Fault in communication of wired controller	
8	E20	Fault in overload protection of System A fan	
9	E21	Fault in overload protection of System B fan	
10	E22	High-pressure protection of System A	
11	E24	Over-current protection of System A compressor	
12	E25	Open circuit or short circuit in exhaust temperature sensor of System A compressor	
13	E26	Open circuit or short circuit in coil (outlet) temperature sensor 1 of System A	
14	E27	Open circuit in low-pressure sensor of System A	
15	E28	Low pressure protection of System A	
16	E29	Open circuit or short circuit in suction temperature sensor of System A	
17	E31	Overtemperature of exhaust temperature sensor of System A compressor	
18	E32	Overtemperature of coil (outlet) temperature sensor 1 of System A	
19	E33	Open circuit or short circuit in coil (outlet) temperature sensor 2 of System A	
20	E34	Open circuit or short circuit in coil (outlet) temperature sensor 2 of System B	
21	E38	Refrigerant lack protection of System C	
22	E39	Refrigerant lack protection of System D	
23	E40	Overtemperature of suction temperature sensor of System C compressor	
24	E41	Overtemperature of suction temperature sensor of System D compressor	
25	E43	Open circuit or short circuit in coil (outlet) temperature sensor 2 of System C	
26	E44	Open circuit or short circuit in coil (outlet) temperature sensor 2 of System D	
27	E45	Fault in overload protection of System C fan	
28	E46	Fault in overload protection of System D fan	
29	E52	High-pressure protection of System B	
30	E54	Over-current protection of compressor of System B	
31	E55	Open circuit or short circuit in exhaust temperature sensor of System B compressor	
32	E56	Open circuit or short circuit in coil (outlet) temperature sensor 1 of System B	
33	E57	Open circuit in low-pressure sensor of System B	
34	E58	Low pressure protection of System B	
35	E59	Open circuit or short circuit in suction temperature sensor of System B	
36	E61	Overtemperature of exhaust temperature sensor of System B compressor	
37	E62	Overtemperature of coil (outlet) temperature sensor 1 of System B	
38	E63	Overload protection of System pump	
39	E64	Overload protection of System electrical assisted heater	
40	E67	Overtop or low protection of outdoor ambient temperature	
41	E68	Refrigerant lack protection of System A	
42	E69	Refrigerant lack protection of System B	

43	E70	Overtemperature of suction temperature sensor of System A compressor	
44	E71	Overtemperature of suction temperature sensor of System B compressor	
45	E72	Overtop Temperature difference of in and out water	
46	E74	Over-current protection of System C compressor	
47	E75	Open circuit or short circuit in exhaust temperature sensor of System C compressor	
48	E76	Open circuit or short circuit in coil (outlet) temperature sensor 1 of System C	
49	E77	Open circuit in low-pressure sensor of System C	
50	E78	Low pressure protection of System C	
51	E79	Open circuit or short circuit in suction temperature sensor of System C	
52	E80	Running time exceeded	
53	E81	Overtemperature of exhaust temperature sensor of System C compressor	
54	E82	Overtemperature of coil (outlet) temperature sensor 1 of System C	
55	E83	High-pressure protection of System C	
56	E87	High-pressure protection of System D	
57	E89	Over-current protection of System D compressor	
58	E90	Open circuit or short circuit in exhaust temperature sensor of System D compressor	
59	E91	Open circuit or short circuit in coil (outlet) temperature sensor 1 of System D	
60	E92	Open circuit in low-pressure sensor of System D	
61	E93	Low pressure protection of System D	
62	E94	Open circuit or short circuit in suction temperature sensor of System D	
63	E96	Overtemperature of exhaust temperature sensor of System D compressor	
64	E97	Overtemperature of coil (outlet) temperature sensor 1 of System D	

Note: E22,, E24, E28, E31, E52, E54, E58 and E61 are severe protection faults. If such faults are repeated three times within 60 min, the corresponding systems fail to automatic recovery, and they must be recovered after troubleshooting in power failure.

Note:

1. If the master unit malfunctions, the master unit stops, without impact on other units (except for flow switch fault).
2. If the slave unit malfunctions, only this unit stops, without impact on other units.

# Maintenance

## Common Faults and Troubleshooting

S/N	Fault description	Possible cause	Troubleshooting	Remarks
1	Too high exhaust pressure	1. Air or non-condensable gas found in the system	Discharge and empty, if necessary, the non-condensable gas	Cooling/heating
		2. High suction pressure	Refer to "High Suction Pressure"	Cooling/heating
		3. Undesirable high-pressure switch	Replace the high-pressure switch	Cooling/heating
		4. Dirty or clogged fin of the condenser	Clean the air-side heat exchanger	Cooling
		5. Insufficient air capacity or faulty fan of the condenser	Check the fan	Cooling
		6. High charge of refrigerant	Adjust the charge of refrigerant	Cooling
		7. High ambient temperature	Inspect the ambient temperature	Cooling
		8. Insufficient water flow	Check the water flow	Heating
		9. Water-side heat exchanger scaling or with foreign matters inside	Clean up the incrustation scale	Heating
		10. High outlet temperature of water-side heat exchanger	Check the water temperature	Heating
2	Low suction pressure	1. Insufficient refrigerant	Adjust the charge of refrigerant	Cooling/heating
		2. Undesirable low-pressure switch	Replace the low-pressure switch	Cooling/heating
		3. Insufficient water flow	Check the water flow	Cooling
		4. Low water inlet temperature at water side	Check the water temperature	Cooling
		5. Water-side heat exchanger scaling or with foreign matters inside	Clean up the incrustation scale	Cooling
		6. Insufficient air capacity	Check the fan	Heating
		7. Short circuit found in air circuit	Check the cause of short circuit and take troubleshooting	Heating
		8. Incomplete defrosting	Replace the poor 4-way valve or defrosting sensor	Heating
3	Too low exhaust pressure	1. Lack of refrigerant	Adjust the charge of refrigerant	Cooling/heating
		2. Low suction pressure	Refer to "Low Suction Pressure"	Cooling/heating
		3. Low ambient temperature of air-side heat exchanger	Check the ambient temperature	Cooling
		4. Too low water temperature at water side	Check the water temperature	Heating
4	High suction pressure	1. Too high charge of refrigerant	Adjust the charge of refrigerant	Cooling/heating
		2. High water inlet temperature at water side	Check the water temperature	Cooling
		3. High ambient temperature of air-side heat exchanger	Check the ambient temperature	Heating
5	Overtemperature of exhaust temperature sensor	1. Poor ventilation around the unit	Clean up the obstacles around the unit, or add air ducts	Heating
		2. Too low ambient temperature	Shut down	Heating
		3. Dirty or clogged filter at fluorine side	Replace the filter	Cooling/heating
		4. Incomplete frosting (for heating) or no frosting	Change the frosting parameters	Heating
6	Open circuit or short circuit of temperature sensor	1. Damaged sensor	Replace the sensor	Cooling/heating
		2. Poor connection of sensor	Reconnect the sensor	
7	Abnormal noise	1. Loose metal plate bolts	Retighten bolts	Cooling/heating
		2. Liquid impact due to entry of liquid refrigerant into the compressor	Adjust the charge of refrigerant or the poor throttling device	
		3. Poor compressor	Replace the compressor	



# Maintenance

## ■ Common Faults and Troubleshooting

S/N	Fault description	Possible cause	Troubleshooting	Remarks
8	Fault in flow switch	1. Air found in the water system	Discharge air via the exhaust valve	Cooling/heating
		2. Water-side heat exchanger scaling or with foreign matters inside	Clean up the incrustation scale	
		3. Poor switch	Replace the target flow switch	
		4. Unevenly distributed flow in water pipelines	Adjust the flow in water pipelines via the shut-off valve	
		5. Out-of-service water pump	Machine installation must be ganged	
		6. Insufficient types of water pumps	Check it and try to fix it	
9	Fault in communication of wired controller	1. Incorrect unit numbering	Check the unit numbering, and correct it.	Cooling/heating
		2. Incorrect connection of communication wires	Check the order of connection of communication wires	
		3. Damaged PCB	Replace the PCB	
		4. Poor wired controller	Replace the wired controller	
10	Over-current fault of compressor	1. High exhaust pressure and high suction pressure	Refer to "High Exhaust Pressure" and "High Suction Pressure"	Cooling/heating
		2. High or low voltage, single phase or phase imbalance	Check the power supply	
		3. Short circuit in motor or terminal	Check the terminal connections	
11	Open circuit in low-pressure sensor	1. Damaged sensor	Replace the sensor	Cooling/heating
		2. Poor connection of sensor	Reconnect the sensor	

## Technical Parameters

### ■ Performance Parameters

Item		Model	CA0035EAND	CA0070EAND	CA0130EAND
Cooling capacity		kW	30	65	130
Heating capacity		kW	33	70	135
Cooling rated power input		kW	9.4	19.2	38.4
Heating rated power input		kW	9.6	19.1	38.2
Max. power input		kW	16.3	28	56
Max. running current		A	27.5	55	110
Compressor	Type	--	Flexible scroll compressor		
	Qty.	EA	1	2	4
	Rated power	kW	9	18	36
Capacity regulating range		---	100%	50%, 100%	25%,50%,75%,100%
Refrigerant	Type	---	R410a		
	Charge	kg	5.5	6X2	5.8 X4
Refrigerant throttling device		---	Electronic expansion valve		
Power supply		---	3N~, 380V, 50Hz		
Air-side heat exchanger	Type	---	Slit fin + efficient inner grooved copper tube		
	Fan type	---	Axial flow fan		
	Fan power	kW	0.7	1.5	3
	Qty.	EA	1	2	4
Water-side heat exchanger	Type	---	Plate heat exchanger	Shell tube heat exchanger	
	Flow	m <sup>3</sup> /h	5.6	12	24
	Water pressure loss	kPa	40	45	60
	Connection dimension	---	DN65	2"	2 1/2"
	Scaling factor	m <sup>2</sup> · °C/kW	0.018		
	Standard pressure-bearing	Kpa	1000		
Net dimensions	Length X Width X Height	mm	918X1038X1710	2060X780X2170	2060X1603X2170
Weight	Net weight	kg	270	630	1090
	Operating weight	kg	300	670	1200
Safety protection	High/low pressure protection, water-break delay protection, anti-freezing protection, motor overload, overheating protection, phase failure and phase sequence protection.				

Note:

1. Nominal refrigerating condition: water outlet temperature is 7°C, ambient temperature is 35°C, and water flow is 0.172[m<sup>3</sup>/(h · kW)].
2. Nominal heating condition: water outlet temperature is 45°C, ambient temperature is 7°C for dry bulb and 6°C for wet bulb, and water flow is listed in the above table.
3. Unit operating range: conforming to GB/T 18430.1& GB/T 18430.2.
4. Scaling factor of circulating water: 0.018m<sup>2</sup> · °C/kW.
5. The specifications in the table may vary with changes in product design without prior notice.

# Operation Instructions

## ■ Unit Service Conditions

### 1. Unit operating range

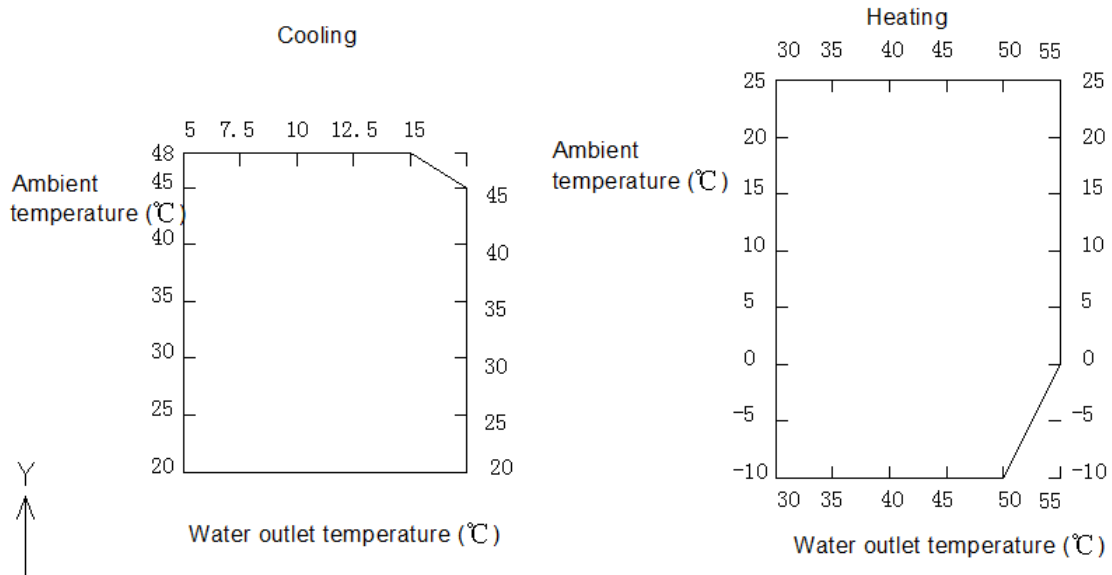

### 2. Service conditions

Item	Contents
Power supply voltage	Within $\pm 10\%$ of the rated voltage
Power supply frequency	Within $\pm 1\%$ of rated frequency
Phase imbalance	Voltage difference between two phases of the power supply is less than 2% of the rated voltage
Chilled water flow	Within $\pm 30\%$ of the rated water flow
Chilled water pressure	Below 0.7MPa
Chilled water quality	Free from corrosive copper, iron, dissolved matters of welding materials
Installation site	Provided with snow protection and ventilation
Ambient temperature	Refer to the above diagram (operating range).
Relative humidity	Below 90%
Optimal operating temperature	12°C for cooling, 40°C for heating

Note: the operating range based on GB/T 18430.1 & GB/T 18430.2, and the rated water flow is obtained from lab. If the unit exceeds the maximum operating range, it only can run for a short time, otherwise the unit may send fault alarm or be damaged.

## Technical Parameters

### ■ Correction factor

#### 1.CA0035EAND

Cooling:

Water outlet temperature (°C)	Ambient temperature (°C)				
	25	30	35	40	45
kW	Cooling capacity	Cooling capacity	Cooling capacity	Cooling capacity	Cooling capacity
5	1.03	0.97	0.94	0.90	0.85
7	1.07	1.03	1.00	0.95	0.88
9	1.10	1.06	1.03	0.98	0.91
11	1.12	1.10	1.08	1.02	0.97
13	1.19	1.20	1.15	1.10	1.05
15	1.31	1.31	1.26	1.20	1.15

Heating:

Water outlet temperature (°C)	Ambient temperature (°C)							
	15	10	7	5	0	-5	-10	-15
kW	Heating capacity	Heating capacity	Heating capacity	Heating capacity	Heating capacity	Heating capacity	Heating capacity	Heating capacity
30	1.23	1.15	1.11	1.06	0.87	0.80	0.71	0.62
35	1.13	1.10	1.08	0.83	0.74	0.68	0.58	0.57
40	1.13	1.09	1.05	0.83	0.74	0.66	0.57	0.55
45	1.13	1.09	1.00	0.83	0.74	0.64	0.57	0.53
50	1.13	1.07	0.92	0.81	0.74	0.64	0.56	0.51
55	1.12	1.06	0.92	0.81	0.72	0.62	-	-

#### 2.CA0070EAND,CA0130EAND

Cooling:

Water outlet temperature (°C)	Ambient temperature (°C)				
	25	30	35	40	45
kW	Cooling capacity	Cooling capacity	Cooling capacity	Cooling capacity	Cooling capacity
5	1.07	1.00	0.94	0.94	0.81
7	1.14	1.07	1.00	0.96	0.86
9	1.20	1.13	1.06	0.98	0.91
11	1.27	1.19	1.12	1.04	0.96
13	1.34	1.26	1.17	1.09	1.01
15	1.41	1.32	1.23	1.14	1.06

Heating:

Water outlet temperature (°C)	Ambient temperature (°C)							
	15	10	7	5	0	-5	-10	-15
kW	Heating capacity	Heating capacity	Heating capacity	Heating capacity	Heating capacity	Heating capacity	Heating capacity	Heating capacity
30	1.26	1.16	1.12	1.07	0.88	0.82	0.72	0.69
35	1.24	1.15	1.11	1.06	0.88	0.81	0.71	0.69
40	1.22	1.14	1.10	1.05	0.87	0.80	0.71	0.67
45	1.19	1.12	1.00	0.98	0.85	0.79	0.70	0.66
50	1.19	1.11	0.98	0.97	0.84	0.78	0.67	0.65
55	1.14	1.07	0.97	0.94	0.83	0.77	-	-

## Warranty Declaration

**Dear users,**

Thank you for selecting and using Haier products. Based upon relevant regulations stipulated in the *Law of the People's Republic of China on Protection of Consumer Rights and Interests* as well as our sincere commitments to you, we offer you the following services by virtue of the warranty and invoice:

1. If you follow the regulations for transport, safeguard, installation, user and maintenance of the unit, we will free of charge repair or replace any defective part of any damaged or faulty unit due to poor workmanship within 18 months as of delivery or 12 months as of commissioning, whichever is earlier. However, artificial damages (e.g. damages caused by external force, operation against rules, installation or maintenance by non-professional units, users' improper transport, hoisting and engineering installation, etc.) and damages due to external force majeure are not covered by the warranty. In such case, we will, according to relevant regulations, charge for repairing or replacing parts at cost.
2. The product receives lifelong maintenance. Where the unit malfunctions beyond the warranty period, we will, according to relevant regulations, charge for services offered at cost.

**Haier after-sales service hotline:**

Headquarters service hotline: 4006 999 999, long-distance call for uncovered areas: 0532-88939999.  
Headquarters service address: No. 609, National Highway 308, Qingdao City; postal code: 266101;  
service E-mail: 9999@haier.com



**Qingdao Haier Air Conditioner Electric Co., Ltd.**

Address: Haier Industrial Park, Qingdao Economic  
and Technological Development Zone

Website: [www.haier.com](http://www.haier.com)

Tel: 4006 999 999

Online repair: <http://service.haier.com>

Version: first edition, 2015

Special No.: 0150517212